

GENERAL CATALOG FOR COMPRESSED AIR, GAS AND VACUUM SOLUTIONS



Atlas Copco



Table of Content

CONTENT	PAGE
INTRODUCTION	2
Drivers of innovation - from idea to customer benefit	3
Energy efficiency is our benchmark	4
Variable Speed Drive (VSD): Reducing energy costs	5
The leader in oil-free compressed air technology	6
Service and optimization for your compressed air system	7
OIL-INJECTED COMPRESSORS	11
Oil-lubricated aluminium piston compressors, 1.5-7.5 kW / 2-10 hp: Automan	14
Industrial oil-lubricated aluminium piston compressors: LE/LT	17
Oil-injected rotary screw compressors, 2-11 kW / 3-15 hp: GX 2-11	20
Oil-injected rotary screw compressors, 5.5-11 kW / 7.5-15 hp: GA 5-11/GA 5-15 VSD	22
Oil-injected rotary screw compressors, with variable speed drive*, 7-37 kW / 10-50 hp: GA 7-37 VSD*	25
Oil-injected rotary screw compressors, 15-22 kW / 20-30 hp: GA 15-22	27
Oil-injected rotary screw compressors, 11-30 kW / 15-40 hp: GA 11*-30/GA 15-30 VSD	29
Oil-injected rotary screw compressors, 30-90 kW / 40-125 hp: GA 30*-90 / GA 37-90 VSD	33
Oil-injected rotary screw compressors, 90-160 kW / 125-200 hp: GA 90*-160* / GA 110-160 VSD	37
Oil-injected rotary screw compressors: 160-500kW / 200-700 hp : GA 160*-500/ GA 315 VSD	40
Oil-injected rotary screw compressors, 110-200 kW / 150-270 hp: GR 110-200	43
Oil-lubricated high-pressure reciprocating compressors, up to 500 bar (a) (7250 psia), 37-165 kW: B&D	45
Oil-lubricated high pressure trunk-piston compressors, up to 351 bar(a) 5090 psia), 22-200 kW: CU/CT/CN	46
Oil-lubricated gas screw compressors, 16 bar(a) (232 psia): GG-VSD	47
Car and bus refueling stations: S100/S750	48
OIL-FREE COMPRESSORS	49
Compact oil-free piston compressors, 0.5-1.5 kW / 0.7-2 hp: LFX 0.7 - 2.0	53
Industrial oil-free aluminum piston compressors, 1.5-7.5 kW / 2-10 hp: LF	55
Oil-free scroll compressors, 1.5-22 kW / 2-30 hp: SF 1-22	57
Water-injected screw compressors, 15-55 kW / 20-75 hp: AQ 30-55 / 15-55 VSD	60
Oil-free rotary tooth compressors, 15-55 kW / 20-75 hp: ZT 15-22, ZR/ZT 30-45, ZR/ZT 22-37-55 VSD	63
Oil-free air- and water-cooled rotary screw compressors, 55-935 kW / 75-1253 hp: Z 55-900 (VSD)	65
Oil-free centrifugal compressors, 355-2750 kW, 475-3500 hp: ZH / ZH*	76
Oil-free high-speed drive centrifugal compressors, 350 kW, 470 hp: ZH 350*	79
Energy recovery control unit for water-cooled oil-free air compressors from 90 to 900 kW. ER 90-900	80
OIL-FREE COMPRESSORS FOR LOW & HIGH PRESSURE APPLICATIONS	82
Oil-free rotary screw compressors, 22-500 kW / 40-700 hp: ZE/ZA (VSD)	85
Oil-free positive displacement screw blowers, 7-132 kW, 10-180 hp: ZS	86
Oil-free Variable Speed Drive positive displacement screw blowers, 18-355 kW, 25-475 hp: ZS+ VSD	87
Oil-free Variable Speed Drive centrifugal air compressors, 100-160 kW, 135-215 hp: ZB 100-160 VSD	88

CONTENT	PAGE
Oil-less multistage centrifugal pressure and vacuum blowers 4 to 2600 kW / 4 to 3600 hp: ZM 31-246	89
Oil-free reciprocating trunk-piston compressors, up to 450 bar (a) (6527 psia), 37 kW: DM	90
Oil-free reciprocating piston compressors, up to 45 bar (652 psig) 37-315 kW /50-422 hp: DX/DN	91
Oil-free reciprocating compressors, up to 150 bar (2175 psig) - up to 560 kW (750 HP): HX HN	92
Oil-free reciprocating piston compressors, up to 40 bar (580 psig), 37-275 kW /50-368 hp: P	93
Oil-free screw and reciprocating piston compressors, up to 40 bar (580 psig), 143-712 kW / 190-954 hp: ZD	95
MEDICAL EQUIPMENT	98
Medical Air Plant uAIR	100
Oil-free piston compressors (LF-MED)	103
Oil-free scroll compressors (SF-MED)	104
Oil-free tooth compressors (ZT-MED)	105
Water-injected screw compressors (AQ-MED)	106
Screw compressors (GA-MED)	107
Medical Air Purifiers (MED / MED*)	109
Medical Vacuum Plant (mVAC)	111
CUSTOM SOLUTIONS FOR RAILWAY, MARINE AND SKI SLOPE APPLICATIONS	114
AIR AND GAS TREATMENT	116
Refrigerant air dryers, 7-1166 l/s, 14-2374 cfm FX	120
Refrigerant air dryers, 6-4000 l/s, 13-8480 cfm: FD	122
Heatless desiccant air dryers, 32-1600 l/s, 68-3392 cfm: CD	127
Heatless desiccant air dryers, 1-1400 l/s, 2-2968 cfm: CD*	128
Blower purge desiccant air dryers, 360-1600 l/s, 763-3392 cfm: BD	130
Blower purge desiccant air dryers, 100-3000 l/s, 212-6360 cfm: BD*	132
Heat of compression rotary drum dryers, 88-2500 l/s, 185-5297 cfm: MD	134
Heat of compression rotary drum dryers, 1800-2500 l/s, 3816-5297 cfm:ND	136
Heat-of-compression desiccant air dryers, 550-3600 l/s, 1165-7628 cfm: XD*	138
Membrane dryers: SD	140
Purification units for breathable air: BAP / BAP*	142
Compressed air purification: Something else you should consider	144
Compressed air filters: DD+, DDp+, PD+, PDp+, QD+ filters	145
Water separators and drains: WSD 25-750 / WD 80 / EWD 50-1500	148
Activated carbon tower, 20-310 l/s, 42-657 cfm: ODT	150
Oil/water separator systems for the condensate treatment: OSC and OSD	152
INDUSTRIAL GASES	154
PSA nitrogen generators, capacity 1-300 l/s, Flow 4-1100 Nm ³ /h purity 95-99.999%: NGP	157
Membrane nitrogen generators, capacity 1.4-140 l/s, Flow 5-500 Nm ³ /h, purity 95-99%: NGM 1-7	159
PSA oxygen generators, capacity 0.6-56 l/s, Flow 2-200 Nm ³ /h, purity 90-95%: OGP	161

Table of Content

CONTENT	PAGE
VACUUM SOLUTIONS	163
Oil-sealed rotary vane vacuum pumps, 20-365 m ³ /h, 12-215 cfm: GVS 20-300	165
Oil-sealed rotary screw vacuum pumps, 557-5734 m ³ /h, 328-3377 cfm: GHS 630-4800	167
2 stage oil-sealed rotary vane vacuum pumps, GVD 0.7-28	169
2 stage oil-sealed rotary vane vacuum pumps, GVD 40-275	171
Vacuum booster pumps, ZRS 250-4200	173
Standard liquid ring vacuum pump packages, AWS & AWD	175
CENTRIFUGAL COMPRESSORS, EXPANDERS AND PUMPS	179
Centrifugal compressors for gas & air applications, up to 200 bar discharge pressure, driver power up to 40 MW: GT	182
Centrifugal compressors for air and nitrogen, discharge pressures up to 32 bar: H	183
Direct-driven centrifugal turbocompressors polyethylene and polypropylene:T	184
Centrifugal compressors for air and gas applications, up to 70 bar: SC	185
Integrally geared centrifugal compressor for gas and air, up to 70 bar: TP	186
Features of turbo compressor products	187
Integrally-geared turbo expanders for air applications, up to 4 MW / 160 bar: ETB, ETG, ETF	188
Radial in capacity FAD expansion turbines (turboexpanders): EC, ECM	189
Integrally geared expander generators for industrial applications or energy recovery: EG, EG _i , EEG _i	190
Low pressure cryogenic vertical turbine pumps: TA & TX	191
Cryogenic high pressure continuous crossover pumps: CC	192
Cryogenic process radial diffuser pumps: RD multiple application pumps	193
TOTAL CUSTOMER CARE	194
Save energy	196
Monitor your products	199
Customer support plans	202
Upgrade your product	206
Genuine parts	208
AIRnet	217

OIL-INJECTED COMPRESSORS

Atlas Copco offers a wide range of oil-injected compressors: from pistons over oil-injected screw compressors, from fixed speed compressors to superior variable speed drive technology...

We offer compressed air solutions for virtually every application and can deliver them, tailored to your exact needs. Our oil-injected compressors are the best choice for all industrial applications requiring high performance, best energy efficiency and premium reliability.

In 1994, Atlas Copco pioneered with variable speed drive technology to offer the market compressed air when they needed it. This technology offers energy savings of 35% on average when compared to fixed speed compressors.

In 2013, Atlas Copco sets a new standard. The GA VSD+ technology is the next step in Variable Speed Drive with energy savings of 50% on average!

Oil-injected compressors

We offer durable piston compressors (such as the LE/LT series) and premium screw compressors with high Volume flow and efficiencies (GA series, from 4 up to 13 bar and GG gas screw up to 16 bar). If somewhat higher pressures are required, our two-stage GR screw compressors are also available (13 to 20 bar). For pressures up to 350 bar, our C series compressors are available for air and gas applications.

VSD - Direct power savings of 35% on average

- Minimal unloading losses
- Volume flow adjusts to current compressed air requirement
- No wasteful idling
- The precise pressure control in the VSD compressors enables a narrow pressure band and a low working pressure, which results in a lower power requirement

GA VSD+ - Direct power savings of 50% on average

- With the new released GA VSD+ improved VSD technology, 50% energy savings on average can be achieved iPM (integrated permanent magnet motor)
- Optimized cooling for all VSD+ units
- No unloader, no blow off losses

Indirect power savings

- The lower working pressure through VSD /VSD+ leads to additional savings of up to 10%
- Lower power requirement for existing base load machines
- Lower leakage losses; e.g., at 6 bar, the air losses are 13% lower than at 7 bar
- Most compressed air applications consume less air at a lower pressure

Whether you cast large diesel engines or vibration dampers for the automotive industry, clean metal parts with sanding machines, or manufacture construction machinery, bicycles, bridge components or household china, we can supply you with the compressed air and gas system you need.

The compressor, the refrigerant dryer, all the filters and condensate drains, the control system, the piping, and even the connections. (Almost) all of them can be integrated into one machine according to your needs – Always reliable and robust, made up of thousands of proven components and extremely efficient. These integrated solutions don't only mean your complete installation has a smaller footprint, in addition to minimal installation costs; you also save even more energy thanks to the reduced pressure drops!

Wherever a compressed air supply is needed, we have the right equipment. Whether it is shipping companies looking for a compressed air supply for ships, or rolling stock manufacturers, suppliers of coke oven machinery, or providers of welding beads for pipeline construction in the desert. Our compressors supply the right air for every purpose and are extremely reliable, even in the harshest conditions.

We have separate engineering teams for marine and railway settings, and have developed specific products for these industries. In the railway industry, for example, our screw compressors supply working air for braking or to control the valves. Our piston compressors support the main engines on ships when they start up; our oil-injected screw compressors supply instrument air on board of ship our equipment can provide the nitrogen required on cargo ships - to extend the shelf life of food being transported by sea, or for cleaning oil pipeline systems. And our spare parts are available worldwide.





Oil-lubricated aluminium piston compressors, 1.5-7.5 kW / 2-10 hp
Automan

High performance, easy operation

Automan compressors are built to provide maximum safety for the user. They require minimal space, are easy to maneuver, and are supplied as a complete ready-to-use system.

- AH 10 - 20E | Page 14
- AF 20 - 30E | Page 15
- AC 20 - 100E | Page 15



Oil-injected rotary screw compressors
GA VSD Series

Power savings of 35% on average

Adapting to the fluctuating compressed air requirement. Precise pressure control, flexible operation, and flexible pressure selection result in considerable power savings.

- GA 5-15 VSD | Page 24
- GA 15-30 VSD | Page 32
- GA 37-90 VSD | Page 36
- GA 110-160 VSD | Page 38



Industrial oil-lubricated aluminium piston compressors
LE/LT

Powerful, durable and reliable

Ideal for trade and industry. Can be individually combined. For smaller air volumes and high performance, with low energy costs and low environmental impact.

- LE/LT 2-20 | Page 18



Oil-injected rotary screw compressors
GA VSD+ Series

On average 50% energy savings

This range provides superior energy savings, with uptimes assured even in the harshest operational conditions. The new vertical set-up also provides a small footprint while silent operation is guaranteed.

- GA VSD+ 7-37 | Page 26



Oil-injected rotary screw compressors, 2-11 kW / 3-15 hp
GX 2-11

Proven industrial technology for your workshop

The proven Atlas Copco screw technology is characterized by optimum performance, high reliability, long service life, and low maintenance requirements.

- GX 2-11 | Page 21



Oil-lubricated high pressure compressors
High Pressure range

A complete offering up to 500 bar.

- B&D | Page 45
- CU/CT/CN | Page 46
- GG-VSD | Page 47
- S100/S750 | Page 48



Oil-injected rotary screw compressors
GA Series

Robust work horses

This series offers the perfect combination of innovative screw technology, environmentally friendly design, and outstanding quality with minimal operation and installation costs. Numerous variants and options offer the ideal compressor for any use.

- GA 5-11 | Page 23
- GA 11+-30 | Page 30
- GA 30+-90 | Page 34
- GA 90+-160+ | Page 38
- GA160+-500 (VSD) | Page 41

Oil-lubricated aluminium piston compressors, 1.5-7.5 kW / 2-10 hp Automan

Automan oil-lubricated aluminium piston compressors are solid, robust and reliable. They are designed for professional applications where they offer trouble-free performance even under demanding circumstances.

CUSTOMER BENEFITS

- Solid reliability** - The Automan tank is powder coated, giving it the best protection against damage and corrosion. Its block is slow running, which extends its lifetime.
- Durable components** - The heavy-duty air intake filter is built to work reliably in dusty conditions and offers long service intervals. The TEFC motor is weather resistant thanks to Class F insulation and IP54 protection. All models are equipped with a pressure reducing valve with quick coupling and D.O.L with a built in pressure differential switch making the compressor complete, ready to operate.
- Minimum maintenance** - All Automan models are built for easy maintenance. The Automan oil, approved by Atlas Copco, is the guarantee for extended compressor lifetime.



AH 15 E 24



AH 20 E 6



AH 10 E 6



AH 15 E 6

AH series oil-free 230 Volt 1 phase - 8 bar(e)/115 psig
Direct drive - portable or mobile - 6 or 24 l horizontal receiver

Type	Installed motor power		Piston displacement		rpm	Cylinders	Stages	Mass	
	hp	kW	l/s	cfm				kg	lbs
AH 10 E 6 silent, portable	1	0.75	1.4	2.9	1450	1	1	15	33
AH 15 E 6 portable	1.5	1.1	2.6	5.6	3400	1	1	10	22
AH 15 E 24 mobile	1.5	1.1	2.6	5.6	3400	1	1	18	40
AH 20 E 6 roll cage, portable	2	1.5	3.2	6.8	2850	1	1	22	48



AF 20 E 6



AF 20 E 10



AF 30 E 22



AF 20 E 24



AF 30 E 24

AF series 230 Volt 1 phase - 8 bar(e)/115 psig for AF 20 E or 10 bar(e)/145 psig for AF 30 E

Direct drive - stationary or mobile – 2 x 11, 6, 10, 24, 50 or 90 l receiver

Type	Installed motor power		Piston displacement		Capacity FAD		rpm	Cylinders	Stages
	hp	kW	l/s	cfm	l/s	cfm			
AF 20 E	2	1.5	3.2	6.8	1.7	3.6	2850	1	1
AF 30 E	3	2.2	5.2	11	3.1	6.6	1450	2	1



AC 75 E 300 V



AC 21 E 90 H



AC 55 E

AC series 230 Volt 1 phase - 10 bar(e)/145 psig

Belt drive - stationary or mobile – 27, 50, 90 or 200 l horizontal alternatively 150 l vertical receiver

Type	Installed motor power		Piston displacement		Capacity FAD		rpm	Cylinders	Stages
	hp	kW	l/s	cfm	l/s	cfm			
AC 21 E	2	1.5	3.1	6.6	1.8	3.8	777	2	1
AC 31 E	3	2.2	5.8	12.3	4.2	8.9	950	2	1

AC series 230 or 400 V 3 phase - 10 bar(e)/145 psig for AC 20-30 E, 11 bar(e)/160 psig for AC 40-100 E |

Belt drive - stationary or mobile – 50, 90, 200, 270 or 500 l horizontal alternatively 270 l vertical receiver - Star Delta starter from 5.5 hp

Type	Installed motor power		Piston displacement		Capacity FAD		rpm	Cylinders	Stages
	hp	kW	l/s	cfm	l/s	cfm			
AC 21 E	2	1.5	3.8	8.1	2.2	4.7	950	2	1
AC 31 E	3	2.2	5.8	12.3	4.2	8.9	950	2	1
AC 40 E	4	3	7.7	16.3	5.7	12.1	1303	2	2
AC 55 E	5.5	4	10.6	22.4	6.9	14.6	975	2	2
AC 75 E	7.5	5.5	13.9	29.5	10.7	23.3	663	2	2
AC 100 E	10	7.5	16.7	35.4	12.9	27.5	795	2	2

AC series 230 or 400 V 3 phase - 14 bar(e)/203 psig

Belt drive - stationary - 300 or 500 l horizontal alternatively 270 l vertical receiver – Star Delta starter from 5.5 hp

Type	Installed motor power		Piston displacement		Capacity FAD		rpm	Cylinders	Stages
	hp	kW	l/s	cfm	l/s	cfm			
AC 40 T	4	3	5.3	11.2	3.9	8.3	896	2	2
AC 55 T	5.5	4	8.1	17.2	5.3	11.2	750	2	2
AC 75 T	7.5	5.5	11.2	23.6	8.6	18.2	530	2	2
AC 100 T	10	7.5	13.9	29.5	10.7	22.7	663	2	2



Petrol & Diesel series 10-14 bar(e)/145-203 psi

Type	Model	Motor			Vessel	Pressure		FAD @ 7 bar		Weight
		hp	kW	Fuel		ltr	bar	psi	l/m	
AC 40 E100 Petrol	Mobile	3.5	2.6	Petrol	100	10	145	188	6.7	71
AC 55 E 50 Petrol	Mobile	4.8	3.6	Petrol	50	10	145	251	8.9	73
AC 55 E 100 Petrol	Mobile	4.8	3.6	Petrol	100	10	145	251	8.9	94
AC 55 E 200 Petrol	Mobile	4.8	3.6	Petrol	200	10	145	251	8.9	120
AC 55 E 11*11 Petrol	Mobile	4.8	3.6	Petrol	11+11	10	145	251	8.9	70
AC 55 E 11*11 R Petrol	Rollbar	4.8	3.6	Petrol	11+11	10	145	254	9.0	70
AC 71 E 25*25 R Petrol	Rollbar	7.1	5.3	Petrol	25+25	10	145	416	14.7	143
AC 71 T 270 Petrol	Stationary	7.1	5.3	Petrol	270	14	203	347	12.3	223
AC 100 T 270 Petrol	Stationary	10.7	8.2	Petrol	270	14	203	571	20.2	235
AC 71 T 270 Diesel	Stationary	7.5	5.5	Diesel	270	14	203	485	17.1	239
AC 110 T 270 Diesel	Stationary	10.9	8.2	Diesel	270	14	203	762	26.9	258
AC 75 T 270 Diesel 2KvA	Stationary	7.5	5.5	Diesel	270	14	203	302	10.7	265
AC 110 T 270 Diesel 2KvA	Stationary	10.9	8.2	Diesel	270	14	203	439	15.5	270
Silencer extension kit Petrol	Option	-	-	Petrol	-	-	-	-	-	-
Silencer extension kit Diesel	Option	-	-	Diesel	-	-	-	-	-	-

Industrial oil-lubricated aluminium piston compressors

LE/LT

Looking for a durable, high-performance compressed air solution for your specific industrial application? Designed with the highest attention to quality, Atlas Copco's LE/LT oil-lubricated aluminium piston compressors stand for exceptional reliability and low operating costs. LE is your compressor for 10 bar and the LT for 15, 20 or 30 bar applications. Incorporating state-of-the-art technology, LE/LT compressors deliver the lowest operating temperatures in the industry, while offering quality air with very low oil carryover. Proven design and high-quality materials ensure performance and extra long life. The LE/LT range is suitable for stand-alone use or easy integration in your OEM product. Atlas Copco also offers an oil-free piston compressor: the LF(x).



LE/LT Compressor

CUSTOMER BENEFITS

- **Solid reliability** – Thanks to a unique, robust design and the optimal combination of quality materials, LE/LT compressors offer improved performance and extended product life. The fan is designed for an optimal cooling air flow.
- **Low running costs** – Operational costs are limited and due to the use of highly durable components the compressors have a long lifetime.
- **Easy maintenance** – All components and service points are easily accessible.
- **Saving floor space** – The compressor block which is directly coupled to the motor is manufactured using lightweight materials. This provides excellent cooling characteristics: ideal for integration with limited space requirements.

FEATURES



- Oil-lubricated or 100% oil-free (see LF compressors)
- Direct drive
- Working pressure up to 30 bar
- IP-55 electric motors with ISO Class F

Valve assembly

The patented stainless steel "Flexi-Disc Valve Assembly" provides a consistent air flow. The system also has a special construction designed for very long operating times

Aluminum construction

The aluminum casing with cooling fins, supported by a large fan, ensures optimum heat dissipation.

Piston – cylinder assembly

The ideal combination of cylinders and pistons has an aluminum-silicon alloy and a graphite insert. This guarantees excellent, smooth operating characteristics, even with too little oil.



LE/LT 2–20
oil-lubricated piston compressors

Type	Maximum working pressure bar	Capacity FAD ⁽¹⁾		Motor rated power kW	Noise level ⁽²⁾		Container volume ⁽³⁾ L	Approx. Weight kg	Dimensions L x W x H mm
		l/s	m ³ /min		db(A)				
LE/LT – Piston compressors									
LE 2–10/90	10	3.40	0.20	1.5	80	65	90	85	1118 x 510 x 1017
LE 3–10/90	10	4.40	0.26	2.2	81	66	90	89	1118 x 510 x 1017
LE 5–10/250	10	8.40	0.50	4.0	81	66	250	150	1852 x 510 x 1082
LE 7–10/250	10	11.70	0.70	5.5	82	70	250	191	1852 x 592 x 1162
LE 10–10/250	10	15.70	0.94	7.5	83	70	250	203	1852 x 592 x 1162
LE 15–10/250	10	18.60	1.12	11.0	86	-	250	330	1852 x 790 x 1200
LE 20–10/250	10	23.90	1.43	15.0	86	-	250	360	1852 x 790 x 1200
LT 2–15/90	15	3.10	0.19	1.5	80	65	90	100	1118 x 533 x 1017
LT 3–15/90	15	4.00	0.24	2.2	81	66	90	104	1118 x 533 x 1017
LT 5–15/250	15	6.70	0.40	4.0	81	66	250	170	1852 x 533 x 1082
LT 7–15/250	15	9.20	0.55	5.5	82	70	250	211	1852 x 606 x 1162
LT 10–15/250	15	11.70	0.70	7.5	83	70	250	223	1852 x 606 x 1162
LT 2–20/90	20	2.10	0.13	1.5	80	65	90	100	1118 x 533 x 1017
LT 3–20/90	20	2.90	0.17	2.2	81	66	90	104	1118 x 533 x 1017
LT 5–20/250	20	5.00	0.30	4.0	81	66	250	170	1852 x 533 x 1082
LT 7–20/250	20	6.70	0.40	5.5	82	70	250	211	1852 x 606 x 1162
LT 10–20/250	20	9.10	0.55	7.5	83	70	250	223	1852 x 606 x 1162
LT 15–20/250	20	15.10	0.91	11.0	86	73	250	333	1852 x 830 x 1980
LT 20–20/250	20	18.00	1.08	15.0	86	73	250	361	1852 x 830 x 1980
LT 3–30	30	2.50	0.15	2.2	81	-	-	49	686 x 533 x 497
LT 5–30	30	4.40	0.26	4.0	81	-	-	51	686 x 533 x 497
LT 7–30	30	6.40	0.38	5.5	82	-	-	90	860 x 606 x 600
LT 10–30	30	8.50	0.51	7.5	83	-	-	102	932 x 606 x 600
LT 15–30	30	9.30	0.56	11.0	83	-	-	166	1024 x 682 x 675
LT 20–30	30	17.00	1.02	15.0	89	-	-	194	1103 x 713 x 675

⁽¹⁾ Capacity FAD measured in accordance with ISO 1217, Ed. 4, Appendix C-2009, reference conditions: dry intake air, intake pressure 1 bar, coolant temperature 20°C. Details for: 10-bar versions at 7 bar, 15-bar versions at 12 bar, 20-bar versions at 20 bar, 30-bar versions at 30 bar. Volume flow reduction through regeneration air requirement on versions with cd dryers.

⁽²⁾ Noise level* measured in accordance with ISO 2151, Edition 2004 with a tolerance of 3 dB(A); right column in table LE/LT for versions with canopy. Voltage 400 V/50 Hz. Other voltages available on request.

⁽³⁾ Other container sizes available on request



We can help you to choose the best option

As well as the product quality and product range, we have focused on a combined product portfolio. This includes compressors with a drive performance of 1.5–15 kW, and flow

of 3.4–24 l/s, as well as a variety of other options. We will help you find a compressor that suits your demands and requirements at all times.

**Special design / options-
the LE / LT series**



LE / LT unit



LE / LT with acoustic enclosure (Pack)



LE-/LT-Trolley mobile version available with electric or petrol engine



LE/LT (15 bar) on standing vessel



LE / LT (15 bar), special version. Complete compressed air station with FX refrigerant dryer and DD + PD filters, on vessel



LE / LT-special version Quality compressed air system with CD adsorption kit on container (volume reduction due to purge air requirement)

Oil-injected rotary screw compressors, 2-11 kW / 3-15 hp GX 2-11

Atlas Copco's oil-injected rotary screw GX compressors are the powerful and reliable industrial screw compressors for small and medium sized industries. The GX compressors are available in various versions (floor mounted, tank mounted, with or without integrated dryer) to provide flexibility. Built from high-quality components and materials, they provide a reliable source of high-quality air in temperatures up to 46°C/115°F.



CUSTOMER BENEFITS

- **Reliability** –The GX series is designed, manufactured and tested in accordance with ISO 9001, ISO 14001 and ISO 1217. The screw compressor technology allows 100% continuous duty cycle and the reinforced frame eliminates resonance. GX compressors are built for a long lifetime of reliable operation.
- **Reduced energy costs** – Our GX compressors offer the low energy consumption and high efficiency of a rotary screw compressor. Compared to piston compressors that suffer from increased energy consumption over time, these screw compressors always provide high efficiency.
- **Plug and play installation** – In addition to boasting a minimum footprint, the GX series discharges cooling air from the top, allowing placement against the wall or in a corner. The tank mounted GX with built-in dryer reduces space requirements even further, making it ideal if you have limited space at your facility.
- **Silent operation** – Atlas Copco supplies GX compressors with full sound enclosures which reduce the sound levels to as low as 61 dB(A). The rotary screw technology minimizes vibration, while optimized cooling air flow enhances quiet operation.
- **Integrated air treatment** –The GX 2-11 FF is available with an advanced built-in refrigerant air dryer. By cooling the compressed air and removing water before it can enter your compressed air network, it prevents rust in your compressed air piping and avoids damage to your air tools.

GX 2-11 SERIES

Easy maintenance at low costs

- Fewer wear parts
- Longer service intervals
- Easy service access with front door and removable side parts
- Guaranteed long service life for components



Type	Max. working pressure		Capacity FAD			Installed motor power*		Noise level	Weight (kg/lbs)*	
	bar(e)	psi	l/s	m ³ /h	cfm	kW	hp	dB(A)	Pack	Full feature***
50 Hz VERSION										
GX 2 EP	10	145	4.0	14.4	8.5	2.2	3	61	165/364	200/441
GX 3 EP	10	145	5.3	19.1	11.2	3	4	61	165/364	200/441
GX 4 EP	10	145	7.8	28.1	16.5	4	5	62	165/364	200/441
GX 5 EP	10	145	10.0	36.0	21.2	5.5	7.5	64	165/364	200/441
GX 7 EP	10	145	14.0	50.4	29.7	7.5	10	66	214/472	264/582
GX 7 EL	7.5	109	19.6	70.6	41.5	7.5	10	65	245/540	314/692
	10	145	16.1	58.0	34.1	7.5	10	65	245/540	314/692
	13	189	12.9	46.4	27.3	7.5	10	65	245/540	314/692
GX 11 EL	7.5	109	27.0	97.2	57.2	11	15	67	257/567	326/719
	10	145	23.3	83.9	49.4	11	15	67	257/567	326/719
	13	189	19.0	68.4	40.3	11	15	67	257/567	326/719
60 Hz VERSION										
GX 2 EP	10.3	150	4.0	14.4	8.5	2.2	3	61	165/364	200/441
GX 4 EP	10.3	150	7.8	28.1	16.5	4	5	62	165/364	200/441
GX 5 EP	10.3	150	10.0	36.0	21.2	5.5	7.5	64	165/364	200/441
GX 7 EP	10.3	150	13.8	49.6	29.2	7.5	10	66	214/472	264/582
GX 7 EL	7.4	107	19.5	70.2	41.3	7.5	10	67	245/540	314/692
	9.1	132	17.3	62.3	36.7	7.5	10	67	245/540	314/692
	10.8	157	14.9	53.6	31.6	7.5	10	67	245/540	314/692
	12.5	181	12.3	44.3	26.1	7.5	10	67	245/540	314/692
GX 11 EL	7.4	107	27.8	100.1	58.9	11	15	68	257/567	326/719
	9.1	132	24.7	88.9	52.3	11	15	68	257/567	326/719
	10.8	157	22.5	81.0	47.7	11	15	68	257/567	326/719
	12.5	181	20.0	72.0	42.4	11	15	68	257/567	326/719

EP: Electropneumatic, EL: Elektronikon.

Standard air receiver size, GX 2-7 EP: 200 l/60 gal, GX 7-11 EL: 270 l/80 gal.

*Unit performance measured according to ISO 1217, ISO 1217, Ed. 4, 2009, Annex C.

**Mean Noise level* (pack variant) measured according to Pneuop/Cagi PN8NTC2 test code; tolerance 3 dB(A).

*** Tank mounted variant.

Available options	GX 2-7 EP	GX 2-7 EP FF	GX 7-11 EL	GX 7-11 EL FF
Integrated aftercooler	-	-	○	●
Water separator (shipped loose)	-	●	○	●
Timer water drain on water separator (shipped loose)	-	-	○	-
Timer drain on air receiver (tank mounted only)	○	○	○	○
Electronic no loss water drain on water separator (shipped loose)	-	●	○	●
Electronic no loss water drain on air receiver (500 l/120 gal tank mounted only)	○	○	○	○
Integrated DDx filter kit	-	-	-	○
Integrated high performance PDx filter kit	-	○	-	○
500 l/120 gal air receiver (tank mounted only)	-	-	○	○
Tropical thermostat	-	-	○	○

- : Not available ●: Standard ○: Optional

	L (mm)	W (mm)	H (mm)
PACK FLOOR MOUNTED			
GX 2-7 EP	620	575/605*	975
GX 7-11 EL	810/840*	590	1085
FULL FEATURE FLOOR MOUNTED			
GX 2-7 EP	-	-	-
GX 7-11 EL	1205/1235*	590	1085
PACK TANK MOUNTED			
GX 2-7 EP	1420	575	1280
GX 7-11 EL**	1533	590	1332
FULL FEATURE TANK MOUNTED			
GX 2-7 EP	1420	575	1280
GX 7-11 EL**	1533	590	1332

* Length with inlet grating.

** Dimensions of GX 7-11 EL tank mounted are 1935 x 590 x 1463 mm (L x W x H) with a 500 l vessel and 1880 x 590 x 1463 mm (L x W x H) with a 120 gal vessel.

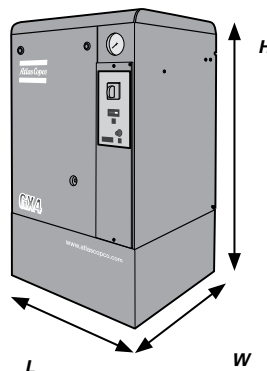

GX 2-7 EP (floor mounted)

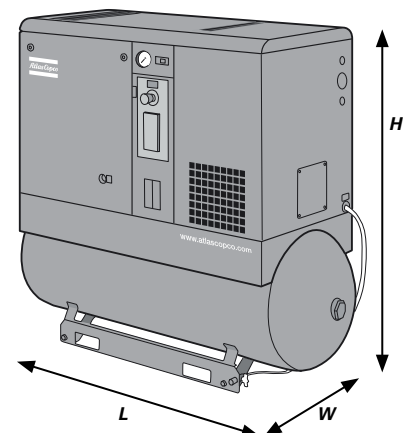

GX 7-11 EL FF (tank mounted)

Oil-injected rotary screw compressors, 5.5-11 KW / 7.5-15 hp GA 5-11/GA 5-15 VSD

Atlas Copco's oil-injected rotary screw compressors are leader in the market thanks to outstanding performance and flexible operation. This results in the highest productivity while minimizing the total cost of ownership. GA compressors are available in two series: GA 5-11 and GA 5-15 VSD. The GA 5-11 is the best workshop solution, built to perform even in the harshest conditions. The GA 5-15 VSD range is the ideal solution for productions with a fluctuating air demand, optimizing your energy consumption. Both ranges supply the high-quality air you need to keep your air network clean and your production up and running.

CUSTOMER BENEFITS

- **Highest reliability** – The GA series is designed, manufactured and tested in accordance with ISO 9001, ISO 14001 and ISO 1217. Ensuring a long and trouble-free life at the lowest operating cost. The compressor contains the latest generation of Atlas Copco's innovative oil-injected screw element.
- **Reduced energy costs** – Our GA compressors can reduce your energy costs and overall compressor lifecycle costs thanks to the use of our highly efficient element. Furthermore, the GA Variable Speed Drive (VSD) reduces energy costs by a further 35% on average by automatically adjusting the air supply to your air demand with a large turndown operating range.
- **Air system integration** – The GA Work Place Air System can be installed where you need compressed air. Its low noise operation and integrated air treatment equipment eliminates the need for a separate compressor room. All GA compressors are tested and delivered ready for use. The integrated options will reduce installation costs and pressure drops significantly, thus saving additional energy cost.
- **Advanced control and monitoring** – To maximize efficiency and reliability, the Elektronikon® controls the main drive motor and regulates system pressure within a predefined and narrow pressure band. The Elektronikon® controller can be adapted to your specific needs with extra sensors, digital contacts, fieldbus, Internet and SMS communication functions. In combination with the ES multiple compressor controller, the operation of your complete compressor room is optimized.
- **Integrated air treatment** – All GA compressors can be installed with integrated dryers, filters to protect your compressed air network. This quality air expands the life of equipment, increasing efficiency and ensuring quality in your final product.



Type	Working pressure workplace		Capacity FAD*			Installed motor power		Noise level	Weight (kg)				
	bar(e)	psig	l/s	m ³ /h	cfm	kW	hp		Workplace		Workplace Full feature		
								Floor-mounted	Tank-mounted	Floor-mounted	Tank-mounted		
50 Hz VERSION													
GA 5	7.5	7.5	109	15.0	54.0	31.7	5.5	7.5	60	257	317	300	360
	8.5	8.5	123	13.2	47.5	27.9	5.5	7.5	60	257	317	300	360
	10	10	145	11.7	42.1	24.7	5.5	7.5	60	257	317	300	360
	13	13	189	8.4	30.2	17.7	5.5	7.5	60	257	317	300	360
GA 7	7.5	7.5	109	21.0	75.6	44.3	7.5	10	61	270	330	315	375
	8.5	8.5	123	21.8	78.5	46.0	7.5	10	61	270	330	315	375
	10	10	145	17.2	70.6	36.3	7.5	10	61	270	330	315	375
	13	13	189	14.2	51.1	30.0	7.5	10	61	270	330	315	375
GA 11	7.5	7.5	109	30.7	110.5	64.8	11	15	62	293	353	343	403
	8.5	8.5	123	28.3	101.9	59.7	11	15	62	293	353	343	403
	10	10	145	26.0	93.6	54.9	11	15	62	293	353	343	403
	13	13	189	22.0	79.2	46.5	11	15	62	293	353	343	403

Type	Max. working pressure workplace		Capacity FAD*			Installed motor power		Noise level	Weight (kg/lbs)				
	bar(e)	psig	l/s	m ³ /h	cfm	kW	hp		Workplace		Workplace Full feature		
								Floor-mounted	Tank-mounted	Floor-mounted	Tank-mounted		
60 Hz VERSION													
GA 5	100	7.4	107	15.0	54.0	31.7	5.5	7.5	60	257	317	300	360
	125	9.1	132	13.2	47.5	27.9	5.5	7.5	60	257	317	300	360
	150	10.8	157	11.7	42.1	24.7	5.5	7.5	60	257	317	300	360
	175	12.5	181	8.4	30.2	17.7	5.5	7.5	60	257	317	300	360
GA 7	100	7.4	107	21.0	75.6	44.3	7.5	10	61	270	330	315	375
	125	9.1	132	21.8	78.5	46.0	7.5	10	61	270	330	315	375
	150	10.8	157	17.2	70.6	36.3	7.5	10	61	270	330	315	375
	175	12.5	181	14.2	51.1	30.0	7.5	10	61	270	330	315	375
GA 11	100	7.4	107	30.4	109.4	64.1	11	15	62	293	353	343	403
	125	9.1	132	27.0	97.2	57.0	11	15	62	293	353	343	403
	150	10.8	157	24.9	89.6	52.5	11	15	62	293	353	343	403
	175	12.5	181	22.0	79.2	46.4	11	15	62	293	353	343	403

* Unit performance measured according to ISO 1217, Ed. 4, 2009, Annex C.

** Mean Noise level* measured at a distance of 1 m according to ISO 2151; tolerance 3 dB(A).

Reference conditions:

- Absolute Inlet pressure, specify bar(a), (e) 1 bar (14.5 psi).
- Intake air temperature 20°C, 68°F.

FAD is measured at the following working pressures:

- 7.5 bar versions at 7 bar(e).
- 8.5 bar versions at 8 bar(e).
- 10 bar versions at 9.5 bar(e).
- 13 bar versions at 12.5 bar(e).

Maximum working pressure for VSD machines:

- 13 bar(e) (188 psig)



GA 5-7-11 pack & GA 5-7-11-15 VSD pack (floor-mounted)

GA 5-7-11 pack & GA 5-7-11-15 VSD pack (tank-mounted)

Type	Max. working pressure workplace		Capacity FAD*			Installed motor power		Noise level**	Weight (kg/lbs)	
	bar(e)	psig	l/s	m³/h	cfm	kW	hp		Work-place	workplace Full Feature
50 / 60 Hz VERSION										
GA 5 VSD	5.5	80	6.1-15.2	22.0-54.7	13.4-33.4	5.5	7.5	62	335	378
	7.5	109	6.0-15.0	21.6-54.0	13.2-33.0	5.5	7.5	62	335	378
	10	145	6.8-11.7	24.5-42.1	15.0-25.7	5.5	7.5	62	335	378
	13	188	8.3-10	29.9-36.0	18.3-22.0	5.5	7.5	62	335	378
GA 7 VSD	5.5	80	5.1-20.5	18.4-73.8	11.2-45.1	7.5	10	64	340	385
	7.5	109	5.1-20.3	18.4-73.1	11.2-44.7	7.5	10	64	340	385
	10	145	6.5-16.8	23.4-60.5	14.3-37.0	7.5	10	64	340	385
	13	188	7.9-13.8	28.4-49.7	17.4-30.4	7.5	10	64	340	385
GA 11 VSD	5.5	80	8.2-31	29.5-111.6	18.0-68.2	11	15	66	353	403
	7.5	109	8.1-30.7	29.2-110.5	17.8-67.5	11	15	66	353	403
	10	145	8.7-24.1	31.3-86.8	19.1-53.0	11	15	66	353	403
	13	188	10.2-20.7	36.7-74.5	22.4-45.5	11	15	66	353	403
GA 15 VSD	5.5	80	9.0-37.5	32.4-135.0	19.8-82.5	15	20	69	360	412
	7.5	109	9.1-37.1	32.8-133.6	20.0-81.6	15	20	69	360	412
	10	145	8.8-30.9	31.7-111.2	19.4-68.0	15	20	69	360	412
	13	188	8.5-24.8	30.6-89.3	18.7-54.6	15	20	69	360	412

* Unit performance measured according to ISO 1217, Ed. 4, 2009, Annex E

** Mean Noise level* measured at a distance of 1 m according to ISO 2151; tolerance 3 dB(A).

Reference conditions:

- Absolute Inlet pressure, specify bar(a), (e) 1 bar (14.5 psi).
- Intake air temperature 20°C, 68°F.

FAD is measured at the following working pressures:

- 7.5 bar versions at 7 bar(e).
- 8.5 bar versions at 8 bar(e).
- 10 bar versions at 9.5 bar(e).
- 13 bar versions at 12.5 bar(e).

Maximum working pressure for VSD machines:

- 13 bar(e) (188 psig)



GA 5-7-11 FF
(floor-mounted)



GA 5-7-11 FF & GA 5-7-11-15 VSD FF
(tank-mounted)

Oil-injected rotary screw compressors, with variable speed drive⁺, 7-37 kW / 10-50 hp

GA 7-37 VSD⁺

Atlas Copco's GA VSD⁺ range brings a game-changing innovation to the general industry. The GA 7-37 VSD⁺ variable speed drive compressor reduces your energy consumption by a staggering 50% on average, compared to idling compressors. At the same time it offers improved performance, silent operation (down to 62 dB(A)) and a compact footprint, thanks to its vertical drive train design. The heart of the GA VSD⁺ is an interior permanent magnet motor, directly coupled to Atlas Copco's best-in-class screw element: all of which have been in-house designed and have patents pending. All these benefits make the GA VSD⁺ the compressor of the future, setting a new standard in the industry for years to come.



CUSTOMER BENEFITS

- **Highest reliability** – The GA VSD⁺ has proven its reliability during extensive field-testing. The drive train is a completely closed, oil-cooled unit that is both quiet and reliable (IP 66), even in the harshest conditions.
- **Exceptional energy savings** – Atlas Copco's GA Variable Speed Drive⁺ (VSD⁺) technology closely follows the air demand by automatically adjusting the motor speed to match the compressed air supply to the air demand. Combined with the innovative design of the iPM (Permanent Magnet) motor (efficiency corresponding to IE4 efficiency), this results in average energy savings of 50% and an average cut of 37% in the lifecycle cost of a compressor. A new, more efficient fan motor achieves another saving on specific energy requirements of up to 7% of the compressor power.
On top of the energy savings, the GA VSD⁺ realizes a free air delivery increase of up to 12%. The design of the motor and the drive train are protected by pending patents.
- **Air system integration** - The GA VSD⁺ is compact, with a footprint that is less than half of the current GA VSD. Thanks to the silent motor and fully-enclosed drive train, this compressor runs as quietly as 62 dB(A). Thanks to its smart design, all maintenance parts are easy accessible and the compressor allows for installation close to a wall or even in corners.
- **Advanced control and monitoring** – To maximize efficiency and reliability, the Elektronikon[®] controls the main drive motor and regulates system pressure within a predefined and narrow pressure band. The Elektronikon[®] controller can be adapted to your specific needs with extra sensors, digital contacts, fieldbus, Internet and SMS communication functions. In combination with the ES multiple compressor controller, the operation of your complete compressor room is optimized.
- **Integrated air treatment** – The GA VSD⁺ is available in a Full Feature version that includes an energy-friendly integrated refrigerant dryer of the newest generation.

Technical specifications	Metric	Imperial
Capacity FAD (l/s)	6.8 - 42.3 l/s	6.8 - 42.3 l/s
Capacity FAD (m ³ /h, cfm)	24.5 - 152.3 m ³ /h	14.4 - 89.6 cfm
Working pressure	4 - 13 bar(e)	58 - 188 psig
Installed motor power	7 - 15 kW	10 - 20 hp

for more information:
go to atlas-copco.com/gavsdplus

Type	Maximum working pressure workplace		Capacity FAD*			Installed motor power		Noise level**	Weight workplace	Weight Workplace Full feature
	bar(e)	psig	l/s	m ³ /h	cfm	kW	hp	dB(A)	kg	kg
GA 7 VSD ⁺	5.5	80	7.1-21.8	25.5-78.5	15.0-46.2	7.5	10	62	193	277
	7	102	7.0-21.6	25.2-77.8	14.8-45.7	7.5	10	62	193	277
	9.5	138	6.7-17.9	24.1-64.4	14.2-37.9	7.5	10	62	193	277
	12.5	181	7.2-14.1	25.9-50.7	15.2-29.8	7.5	10	62	193	277
GA 11 VSD ⁺	5.5	80	7.2-32.4	25.9-116.6	15.2-68.6	11	15	63	196	280
	7	102	7.1-32.0	25.5-115.2	15.0-67.8	11	15	63	196	280
	9.5	138	6.9-26.8	24.8-96.5	14.6-56.8	11	15	63	196	280
	12.5	181	7.5-23.1	27.0-115.6	15.9-48.9	11	15	63	196	280
GA 15 VSD ⁺	5.5	80	7.1-41.2	25.5-148.3	15.0-87.3	15	20	64	199	288
	7	102	7.0-40.8	25.2-146.9	14.8-86.4	15	20	64	199	288
	9.5	138	6.7-34.6	24.1-124.5	14.2-73.3	15	20	64	199	288
	12.5	181	7.1-27.2	25.5-97.9	15.0-57.6	15	20	64	199	288
GA 18 VSD ⁺	4	58	15.0-63.2	53.9-227.5	31.7-133.8	18	25	67	367	480
	7	102	14.7-61.8	53.0 - 222.6	31.2 - 131.0	18	28	67	367	480
	9.5	138	16.9-53.0	61.0-190.8	35.9-112.3	18	25	67	367	480
	12.5	181	16.3-43.0	58.5-154.8	34.4-91.1	18	25	67	367	480
GA 22 VSD ⁺	4	58	15.2-76.1	54.6-274.0	32.1-161.2	22	30	67	363	485
	7	102	14.8-74.3	53.3-267.6	31.3-157.4	22	30	67	363	485
	9.5	138	17.1-64.5	61.5-232.1	36.2-136.6	22	30	67	363	485
	12.5	181	16.9-53.5	60.7-192.5	35.7-113.2	22	30	67	363	485
GA 26 VSD ⁺	4	58	14.8-85.8	53.2-309.0	31.3-181.8	26	35	67	373	490
	7	102	14.5-85.3	52.1-307.2	30.6-180.7	26	35	67	373	490
	9.5	138	16.9-77.9	60.7-280.5	35.7-165.1	26	35	67	373	490
	12.5	181	16.3-64.1	58.8-230.8	34.6-135.8	26	35	67	373	490
GA 30 VSD ⁺	4	58	15.1-98.0	54.3-352.8	31.9-207.6	30	40	67	376	500
	7	102	15.0-97.4	54.1-350.5	31.8-206.2	30	40	67	376	500
	9.5	138	17.2-85.6	61.7-308.2	36.3-181.3	30	40	67	376	500
	12.5	181	16.7-72.0	60.0-259.1	35.3-152.4	30	40	67	376	500
GA 37 VSD ⁺	4	58	15.3-116.4	55.1-418.9	32.4-246.4	37	50	7	376	500
	7	102	14.8-114.8	53.2-413.2	31.3-243.1	37	50	67	376	500
	9.5	138	17.1-102.1	61.5-367.7	36.2-216.3	37	50	67	376	500
	12.5	181	16.4-86.6	58.9-311.8	34.6-183.4	37	50	67	376	500

* Unit performance measured according ISO 1217, Ed. 4, 2009, Annex E.

** Mean noise level* measured at a distance of 1 m according to ISO 2151: 2004 using ISO 9614/2 (sound intensity method); tolerance 3 dB(A).

Reference conditions:

- Absolute inlet pressure 1 bar (14.5 psi).
- Intake air temperature 20°C, 68°F.

FAD is measured at the following effective working pressures:

- 5.5 bar(e)
- 7 bar(e)
- 9.5 bar(e)
- 12.5 bar(e)

Maximum working pressure:

- 13 bar(e) (188 psig)

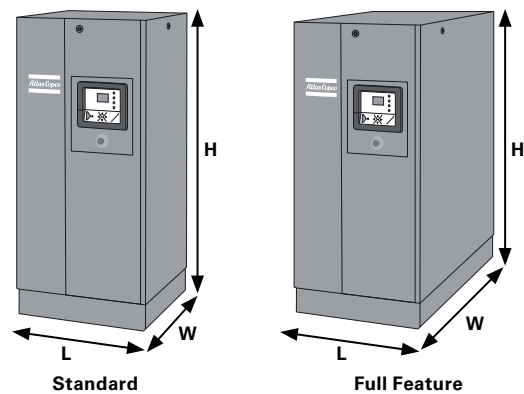

Dimensions	Standard			Full Feature		
	L (mm)	W (mm)	H (mm)	L (mm)	W (mm)	H (mm)
GA 7-15 VSD ⁺	630	610	1420	630	985	1420
GA 18-37 VSD ⁺	780	811	1590	780	1273	1590

Oil-injected rotary screw compressors, 15-22 kW / 20-30 hp

GA 15-22

Atlas Copco's oil-injected rotary screw compressors are leader in the market thanks to outstanding performance and flexible operation. This results in the highest productivity while minimizing the total cost of ownership. GA compressors are built to perform even in the harshest environments; these products will keep your production running smoothly.

CUSTOMER BENEFITS

- **Highest reliability** – The GA series is designed, manufactured and tested in accordance with ISO 9001, ISO 14001 and ISO 1217. Ensuring a long and trouble-free life at the lowest operating cost. GA compressors are equipped with the latest generation of Atlas Copco's innovative oil-injected screw element.
- **Reduced energy costs** – Our GA compressors can reduce your energy costs and overall compressor lifecycle costs thanks to the use of our highly efficient element and motors, and minimal internal losses.
- **Air system integration** – The GA WorkPlace Air System can be installed where you need compressed air. Its low noise operation and integrated air treatment equipment eliminates the need for a separate compressor room. All GA compressors are tested and delivered ready for use. The integrated options will reduce installation costs and pressure drops significantly, thus saving additional energy cost.
- **Advanced control and monitoring** – To maximize efficiency and reliability, the Elektronikon® controls the main drive motor and regulates system pressure within a predefined and narrow pressure band. The Elektronikon® controller can be adapted to your specific needs with extra sensors, digital contacts, fieldbus, Internet and SMS communication functions. In combination with the ES multiple compressor controller, the operation of your complete compressor room is optimized.
- **Integrated air treatment** – All GA compressors have integrated dryer and filters available to protect your compressed air network. This quality air expands the life of equipment, increasing efficiency and ensuring quality in your final product.



Type	Max. working pressure		Capacity FAD*	Installed motor power	Noise Level**	Weight
	Workplace/ workplace FF					
	bar(e)		m ³ /h	kW	dB(A)	kg
50 Hz VERSION						
GA 15	7.5	7.5/7.3	154.8	15	72	375/440
	8.5	8.5/8.3	141.8	15	72	375/440
	10	10/9.8	130.7	15	72	375/440
	13	13/12.8	108.4	15	72	375/440
GA 18	7.5	7.5/7.3	189	18.5	73	395/470
	8.5	8.5/8.3	180.7	18.5	73	395/470
	10	10/9.8	156.6	18.5	73	395/470
	13	13/12.8	133.9	18.5	73	395/470
GA 22	7.5	7.5/7.3	216.7	22	74	410/485
	8.5	8.5/8.3	209.9	22	74	410/485
	10	10/9.8	186.1	22	74	410/485
	13	13/12.8	162	22	74	410/485

60 Hz VERSION						
		psig	cfm	hp	dB(A)	lbs
GA 15	100	107/104	90.1	20	72	827/970
	125	132/128	83.9	20	72	827/970
	150	157/149	75.9	20	72	827/970
	175	181/178	62.1	20	72	827/970
GA 18	100	107/104	108.7	25	73	871/1036
	125	132/128	101.1	25	73	871/1036
	150	157/149	91.7	25	73	871/1036
	175	181/178	80.1	25	73	871/1036
GA 22	100	107/104	128.4	30	74	904/1069
	125	132/128	118.7	30	74	904/1069
	150	157/149	107.4	30	74	904/1069
	175	181/178	98.5	30	74	904/1069

* Unit performance measured according to ISO 1217, Ed. 4, 2009, Annex C.

** Mean noise level* measured according to ISO 2151/Pneuro/Cagi PN8NTC2 test code; tolerance 2 dB(A)

Pressure dew point of integrated refrigerant dryer of GA 15 - GA 18 - GA 22 at reference conditions 5°C, 41°F.

Air receiver size : 500 l.
Added weight: 125 kg.

Reference conditions:

- Absolute inlet pressure 1 bar (14.5 psi)
- Intake air temperature 20°C, 68°F

FAD is measured at the following working pressures:

- 7.5 bar versions at 7 bar
- 8.5 bar versions at 8 bar
- 10 bar versions at 9.5 bar
- 13 bar versions at 12.5 bar

GA 15 - GA 18 - GA 22 Full feature

H: 1558 mm, 61"
L: 1853 mm, 73"
W: 680 mm, 27"



GA 15 - GA 18 - GA 22 Pack

H1: 1558 mm, 61"
H2: 932 mm, 37"
L1: 1853 mm, 73"
L2: 1285 mm, 51"
W: 680 mm, 27"



Oil-injected rotary screw compressors, 11-30 kW / 15-40 hp GA 11⁺-30/GA 15-30 VSD

Atlas Copco's oil-injected rotary screw compressors are leader in the market thanks to outstanding performance and flexible operation. This results in the highest productivity while minimizing the total cost of ownership. GA compressors are available in two series, GA⁺ 11-30 and GA 15-30 VSD, enabling you to perfectly match your requirements for compressed air solutions. Built to perform even in the harshest environments, these products will keep your production running efficiently.

CUSTOMER BENEFITS

- **Highest reliability** – The GA series is designed, manufactured and tested in accordance with ISO 9001, ISO 14001 and ISO 1217. Ensuring a long and trouble-free life at the lowest operating cost. GA compressors are equipped with the latest generation of Atlas Copco's innovative oil-injected screw element integrated with a closed gear drive eliminating the need for a coupling suitable for the harshest environment.
- **Reduced energy costs** – GA compressors can reduce your energy costs and overall compressor lifecycle costs thanks to the use of our highly efficient element and motors. The GA Variable Speed Drive (VSD) also reduces energy costs by a further 35% on average by automatically adjusting the air supply to your air demand with a large turndown operating range.
- **Air system integration** – The GA WorkPlace Air System can be installed where you need compressed air. Its low noise operation and integrated air treatment equipment eliminates the need for a separate compressor room. All GA compressors are tested and delivered ready for use. The integrated options will reduce installation costs and pressure drops significantly, thus saving additional energy cost.
- **Advanced control and monitoring** – To maximize efficiency and reliability, the Elektronikon[®] controls the main drive motor and regulates system pressure within a predefined and narrow pressure band. The Elektronikon[®] controller can be adapted to your specific needs with extra sensors, digital contacts, fieldbus, Internet and SMS communication functions. In combination with the ES multiple compressor controller, the operation of your complete compressor room is optimized.
- **Integrated air treatment** – All GA compressors have integrated dryer, filters and oil-water separator available to protect your compressed air network. This quality air expands the life of equipment, increasing efficiency and ensuring quality in your final product.



A PLUS FOR PERFORMANCE



GA⁺ series: Your advantage for more power and efficiency

With the new GA⁺ series, Atlas Copco is offering premium oil-injected screw compressors with excellent volume flow and high efficiency.

The improved performance is a direct result of the multitude of innovations that have been integrated into the compressor unit.

- Higher volume flow
- Lower specific power input
- Improved efficiency

50 Hz versions

Type	Max. working pressure				Capacity FAD*			Installed motor power		Noise level	Weight (kg)		Length (mm)	Width (mm)	Height (mm)	
	Workplace		Workplace Full feature								Work-Place	Work-place Full feature				
	bar(e)	psig	bar(e)	psig	l/s	m ³ /h	cfm	kW	hp	dB(A)						
50 Hz VERSION																
GA 11+	7.5	7.5	109	7.3	105	35.8	128.9	75.9	11	15	63	410	455	1255	692	1475
	8.5	8.5	116	8.3	120	33.8	121.7	71.7	11	15	63	410	455	1255	692	1475
	10	10	145	9.8	141	30.3	109.1	64.2	11	15	63	410	455	1255	692	1475
	13	13	189	12.8	185	25.2	90.7	53.4	11	15	63	410	455	1255	692	1475
GA 15+	7.5	7.5	109	7.3	105	46.9	168.8	99.4	15	20	64	420	470	1255	692	1475
	8.5	8.5	116	8.3	120	43.8	157.7	92.9	15	20	64	420	470	1255	692	1475
	10	10	145	9.8	141	39.8	143.3	84.4	15	20	64	420	470	1255	692	1475
	13	13	189	12.8	185	32.8	118.1	69.5	15	20	64	420	470	1255	692	1475
GA 18+	7.5	7.5	109	7.3	105	58.1	209.2	123.2	18.5	25	65	440	500	1255	692	1475
	8.5	8.5	116	8.3	120	54.3	195.5	115.1	18.5	25	65	440	500	1255	692	1475
	10	10	145	9.8	141	48.7	175.3	103.2	18.5	25	65	440	500	1255	692	1475
	13	13	189	12.8	185	41.1	148.0	87.1	18.5	25	65	440	500	1255	692	1475
GA 22+	7.5	7.5	109	7.3	105	68.2	245.5	144.6	22	30	66	455	515	1255	692	1475
	8.5	8.5	116	8.3	120	64.5	232.2	136.7	22	30	66	455	515	1255	692	1475
	10	10	145	9.8	141	58.1	209.2	123.2	22	30	66	455	515	1255	692	1475
	13	13	189	12.8	185	50.7	182.5	107.5	22	30	66	455	515	1255	692	1475
GA 26+	7.5	7.5	109	7.3	105	79.8	287.3	169.2	26	35	67	525	595	1255	865	1475
	8.5	8.5	116	8.3	120	76.2	274.3	161.5	26	35	67	525	595	1255	865	1475
	10	10	145	9.8	141	69.3	249.5	146.9	26	35	67	525	595	1255	865	1475
	13	13	189	12.8	185	60.1	216.4	127.4	26	35	67	525	595	1255	865	1475
GA 30	7.5	7.5	109	7.3	105	90.0	324.0	190.8	30	40	68	540	610	1255	865	1475
	8.5	8.5	116	8.3	120	86.4	311.0	183.2	30	40	68	540	610	1255	865	1475
	10	10	145	9.8	141	79.8	287.3	169.2	30	40	68	540	610	1255	865	1475
	13	13	189	12.8	185	68.7	247.3	145.6	30	40	68	540	610	1255	865	1475

* Unit performance measured according to ISO 1217, ISO 1217, Ed. 4, 2009, Annex C, latest edition.

** Mean Noise level* measured according to ISO 2151/Pneuro/Cagi

PN8NTC2 test code; tolerance 2 dB(A).

Reference conditions:

- Absolute Inlet pressure, specify bar(a), (e) 1 bar (14.5 psi)
- Intake air temperature 20°C, 68°F

Pressure dew point of integrated refrigerant dryer of GA 11+ - GA 15+ - GA 18+ - GA 22+ - GA 26+ - GA 30 at reference conditions 2°C to 3°C, 36°F to 37°F.

FAD is measured at the following working pressures:

- 7.5 bar versions at 7 bar
- 8 bar versions at 7.5 bar
- 10 bar versions at 9.5 bar
- 13 bar versions at 12.5 bar

GA 11+ - GA 15+ - GA 18+ - GA 22+

H: 1475 mm, 58"
L: 1255 mm, 49"
W: 692 mm, 27"



60 Hz versions

Type	Max. working pressure				Capacity FAD*			Installed motor power		Noise level	Weight (kg)		Length (mm)	Width (mm)	Height (mm)	
	Workplace		Workplace Full feature								Workplace	Workplace Full feature				
	bar(e)	psig	bar(e)	psig	l/s	m³/h	cfm	kW	hp	dB(A)						
60 Hz VERSION																
GA 11+	100	7.4	107	7.2	104	37.0	133.2	78.4	11	15	63	410	455	1255	692	1475
	125	9.1	132	8.9	128	32.0	115.2	67.8	11	15	63	410	455	1255	692	1475
	150	10.8	157	10.3	149	29.3	105.5	62.1	11	15	63	410	455	1255	692	1475
	175	12.5	181	12.3	178	25.3	91.1	53.6	11	15	63	410	455	1255	692	1475
GA 15+	100	7.4	107	7.2	104	48.3	173.9	102.4	15	20	64	420	470	1255	692	1475
	125	9.1	132	8.9	128	42.9	154.4	90.9	15	20	64	420	470	1255	692	1475
	150	10.8	157	10.3	149	39.4	141.8	83.5	15	20	64	420	470	1255	692	1475
	175	12.5	181	12.3	178	33.9	122.0	71.9	15	20	64	420	470	1255	692	1475
GA 18+	100	7.4	107	7.2	104	59.6	214.6	126.4	18.5	25	66	440	500	1255	692	1475
	125	9.1	132	8.9	128	53.3	191.9	113.0	18.5	25	66	440	500	1255	692	1475
	150	10.8	157	10.3	149	47.8	172.1	101.3	18.5	25	66	440	500	1255	692	1475
	175	12.5	181	12.3	178	42.5	153.0	90.1	18.5	25	66	440	500	1255	692	1475
GA 22+	100	7.4	107	7.2	104	70.3	253.1	149.0	22	30	67	455	515	1255	692	1475
	125	9.1	132	8.9	128	62.9	226.4	133.3	22	30	67	455	515	1255	692	1475
	150	10.8	157	10.3	149	56.9	204.8	120.6	22	30	67	455	515	1255	692	1475
	175	12.5	181	12.3	178	52.3	188.3	110.9	22	30	67	455	515	1255	692	1475
GA 26+	100	7.4	107	7.2	104	81.2	292.3	172.1	26	35	67	525	595	1255	865	1475
	125	9.1	132	8.9	128	74.1	266.8	157.1	26	35	67	525	595	1255	865	1475
	150	10.8	157	10.3	149	67.4	242.6	142.9	26	35	67	525	595	1255	865	1475
	175	12.5	181	12.3	178	60.7	218.5	128.7	26	35	67	525	595	1255	865	1475
GA 30	100	7.4	107	7.2	104	90.1	324.4	191.0	30	40	68	540	610	1255	865	1475
	125	9.1	132	8.9	128	84.1	302.8	178.3	30	40	68	540	610	1255	865	1475
	150	10.8	157	10.3	149	77.1	277.6	163.5	30	40	68	540	610	1255	865	1475
	175	12.5	181	12.3	178	70.1	252.4	148.6	30	40	68	540	610	1255	865	1475

* Unit performance measured according to ISO 1217, ISO 1217, Ed. 4, 2009, Annex C.

** Mean Noise level* measured according to ISO 2151/Pneuro/Cagi PN8NTC2 test code; tolerance 2 dB(A).

Reference conditions:

- Absolute Inlet pressure, specify bar(a), (e) 1 bar (14.5 psi)
- Intake air temperature 20°C, 68°F

Pressure dew point of integrated refrigerant dryer of GA 11+ - GA 15+ - GA 18+

- GA 22+ - GA 26+ - GA 30 at reference conditions 2°C to 3°C, 35°F to 37°F.

FAD is measured at the following working pressures:

- 7.5 bar versions at 7 bar
- 8 bar versions at 7.5 bar
- 10 bar versions at 9.5 bar
- 13 bar versions at 12.5 bar

GA 26+ - GA 30
 H: 1475 mm, 58"
 L: 1255 mm, 49"
 W: 865 mm, 34"



GA 15-30 VSD

Type	Max. working pressure		Capacity FAD						Installed motor power		Noise level 50/60 Hz	Weight (kg)		Length (mm)	Width (mm)	Height (mm)
	Workplace		l/s		m³/h		cfm					Work-Place	Work-place Full feature			
	bar(e)	psig	Min.	Max.	Min.	Max.	Min.	Max.	kW	hp	dB(A)					
GA 15 VSD	4	58	16.0	48.7	57.6	175.3	33.9	103.2	15	20	66	480	530	1255	865	1475
	7	102	15.9	48.5	57.2	174.6	33.7	102.8	15	20	66	480	530	1255	865	1475
	10	145	18.0	41.6	64.8	149.8	38.2	88.2	15	20	66	480	530	1255	865	1475
	13	188	20.4	32.8	73.4	118.1	43.2	69.5	15	20	65	480	530	1255	865	1475
GA 18 VSD	4	58	16.0	60.1	57.6	216.4	33.9	127.4	18	25	67	490	550	1255	865	1475
	7	102	15.9	60.0	57.2	216.0	33.7	127.2	18	25	67	490	550	1255	865	1475
	10	145	18.0	52.0	64.8	187.2	38.2	110.2	18	25	67	490	550	1255	865	1475
	13	188	20.4	42.0	73.4	151.2	43.2	89.0	18	25	66	490	550	1255	865	1475
GA 22 VSD	4	58	16.0	70.5	57.6	253.8	33.9	149.5	22	30	68	500	560	1255	865	1475
	7	102	15.9	70.3	57.2	253.1	33.7	149.5	22	30	68	500	560	1255	865	1475
	10	145	18.0	61.4	64.8	221.0	38.2	130.2	22	30	68	500	560	1255	865	1475
	13	188	20.4	50.2	73.4	180.7	43.2	106.4	22	30	67	500	560	1255	865	1475
GA 26 VSD	4	58	16.0	81.5	57.6	293.4	33.9	172.8	26	35	70	520	590	1255	865	1475
	7	102	15.9	81.2	57.2	292.3	33.7	172.1	26	35	70	520	590	1255	865	1475
	10	145	18.0	72.4	64.8	260.6	38.2	153.5	26	35	70	520	590	1255	865	1475
	13	188	20.4	59.7	73.4	214.9	43.2	126.6	26	35	69	520	590	1255	865	1475
GA 30 VSD	4	58	16.0	93.3	57.6	335.9	33.9	197.8	30	35	70	530	600	1255	865	1475
	7	102	15.9	93.0	57.2	334.8	33.7	197.2	30	35	70	530	600	1255	865	1475
	10	145	18.0	82.7	64.8	297.7	38.2	175.3	30	35	70	530	600	1255	865	1475
	13	188	20.4	70.8	73.4	254.9	43.2	150.1	30	35	69	530	600	1255	865	1475

* Unit performance measured according to ISO 1217, ISO 1217, Ed. 4, 2009, Annex E.

** Mean Noise level* measured according to ISO 2151/Pneuro/Cagi PN8NTC2 test code; tolerance 2 dB(A).

Pressure dew point of integrated refrigerant dryer at reference conditions: 2°C to 3°C, 35°F to 37°F.

Reference conditions:

- Absolute Inlet pressure, specify bar(a), (e) 1 bar (14.5 psi)
- Intake air temperature 20°C, 68°F

Maximum working pressure for VSD machines: 13 bar(e) (188 psig)

GA 15 VSD - GA 18 VSD -
GA 22 VSD - GA 30 VSD

H: 1475 mm
L: 1255 mm
W: 862 mm



Oil-injected rotary screw compressors, 30-90 kW / 40-125 hp GA 30⁺-90 / GA 37-90 VSD

Atlas Copco's oil-injected rotary screw GA compressors are leaders in the market, with outstanding reliable performance. Their flexible operation results in the highest productivity, while minimizing the total cost of ownership. GA compressors are available in three series – GA, GA⁺ and GA VSD – enabling you to perfectly match your requirements for compressed air solutions. Built to perform even in the harshest environments, these products will keep your production running efficiently.

CUSTOMER BENEFITS

- Highest reliability** – The GA series is designed, manufactured and tested in accordance with ISO 9001, ISO 14001 and ISO 1217. The latest generation of Atlas Copco's innovative oil-injected screw element ensures a long and trouble-free life, at the lowest operating costs. The integrated closed gear drive eliminates the need for a coupling thus reducing maintenance requirements while increasing GA reliability suitable for the harshest environments.
- Reduced energy costs** – Our GA / GA⁺ compressors can reduce your energy costs and overall compressor lifecycle costs thanks to the use of our highly efficient element and motors. Furthermore, the GA Variable Speed Drive (VSD) reduces energy costs by a further 35% on average by automatically adjusting the air supply to your air demand with a large turndown operating range.
- Air system integration** – The GA WorkPlace Air System can be placed where you need it. Its low noise operation and integrated air treatment equipment eliminate the need for a separate compressor room. All GA compressors are delivered ready for use, significantly reducing installation costs, pressure drops and thus saving additional energy cost.
- Advanced control and monitoring** – To maximize efficiency and reliability, the Elektronikon[®] controls the main drive motor and regulates system pressure within a predefined and narrow pressure band. The Elektronikon[®] controller can be adapted to your specific needs with extra sensors, digital contacts, fieldbus, Internet and SMS communication functions. In combination with the ES multiple compressor controller, the operation of your complete compressor room is optimized.
- Integrated air treatment** – All GA compressors are available with an integrated dryer that efficiently removes moisture, aerosols and dirt particles to protect your investment. This quality air expands the life of equipment, increasing efficiency and ensuring quality in your final product.



iOS app

Download a QR Reader and scan the code for our interactive leaflet.



Android app



50 Hz versions

Type	Pressure variant	Max. working pressure workPlace		Capacity FAD*			Installed motor power		Noise level	Weight workplace		Weight workplace Full feature	
		bar(e)	psig	l/s	m ³ /min	cfm	kW	hp		kg	lbs	kg	lbs
GA 30+	7.5	7.5	109	99	5.9	209	30	40	65	817	1801	898	1980
	8.5	8.5	123	90	5.4	191	30	40	65	817	1801	898	1980
	10	10	145	82	4.9	175	30	40	65	817	1801	898	1980
	13	13	189	71	4.3	151	30	40	65	817	1801	898	1980
GA 37	7.5	7.5	109	115	6.9	243	37	50	69	905	1994	820	1807
	8.5	8.5	123	106	6.4	225	37	50	69	905	1995	820	1808
	10	10	145	100	6.0	213	37	50	69	905	1995	820	1808
	13	13	189	81	4.9	172	37	50	69	905	1995	820	1808
GA 37+	7.5	7.5	109	122	7.3	258	37	50	65	902	1989	987	2176
	8.5	8.5	123	118	7.1	250	37	50	65	902	1989	987	2176
	10	10	145	102	6.1	216	37	50	65	902	1989	987	2176
	13	13	189	85	5.1	180	37	50	65	902	1989	987	2176
GA 45	7.5	7.5	109	137	8.2	291	45	60	72	894	1971	979	2158
	8.5	8.5	123	127	7.6	268	45	60	72	894	1971	979	2158
	10	10	145	117	7.0	248	45	60	72	894	1971	979	2158
	13	13	189	102	6.1	217	45	60	72	894	1971	979	2158
GA 45+	7.5	7.5	109	149	8.9	315	45	60	66	970	2138	1060	2337
	8.5	8.5	123	139	8.3	295	45	60	66	970	2138	1060	2337
	10	10	145	128	7.7	270	45	60	66	970	2138	1060	2337
	13	13	189	106	6.4	225	45	60	66	970	2138	1060	2337
GA 55	7.5	7.5	109	169	10.2	359	55	75	69	1229	2709	1329	2930
	8.5	8.5	123	159	9.5	336	55	75	69	1229	2709	1329	2930
	10	10	145	148	8.9	313	55	75	69	1229	2709	1329	2930
	13	13	189	126	7.6	267	55	75	69	1229	2709	1329	2930
GA 55+	7.5	7.5	109	184	11.1	390	55	75	66	1358	2994	1458	3214
	8.5	8.5	123	174	10.4	369	55	75	66	1358	2994	1458	3214
	10	10	145	156	9.5	331	55	75	66	1358	2994	1458	3214
GA 75	7.5	7.5	109	226	13.5	478	75	100	73	1259	2776	1379	3040
	8.5	8.5	123	209	12.6	444	75	100	73	1259	2776	1379	3040
	10	10	145	189	11.4	401	75	100	73	1259	2776	1379	3040
	13	13	189	162	9.7	344	75	100	73	1259	2776	1379	3040
GA 75+	7.5	7.5	109	248	14.9	526	75	100	68	1413	3115	1533	3380
	8.5	8.5	123	235	14.1	497	75	100	68	1413	3115	1533	3380
	10	10	145	210	12.6	445	75	100	68	1413	3115	1533	3380
	13	13	189	177	10.6	375	75	100	68	1413	3115	1533	3380
GA 90	7.5	7.5	109	281	16.9	596	90	125	73	1425	3142	1545	3406
	8.5	8.5	123	275	16.5	582	90	125	73	1425	3142	1545	3406
	10	10	145	250	15.0	529	90	125	73	1425	3142	1545	3406
	13	13	189	216	13.0	458	90	125	73	1425	3142	1545	3406

* Unit performance measured according to ISO 1217, Ed. 4, 2009, Annex C.

Reference conditions:

Absolute Inlet pressure, specify bar(a), (e) 1 bar (14.5 psi)

Intake air temperature 20°C, 68°F

FAD is measured at the following working pressures:

7.5 bar versions at 7 bar

8.5 bar versions at 8 bar

10 bar versions at 9.5 bar

13 bar versions at 12.5 bar

** A-weighted emission Noise level* at the work station, Lp WSA (re 20 µPa) dB (with uncertainty 3 dB).

Values determined according to Noise level* test code ISO 2151 and noise measurement standard ISO 9614.

Pressure dew point of integrated refrigerant dryer at reference conditions: 2°C to 3°C, 36°F to 37°F.

60 Hz versions

Type	Pres- sure variant	Max. working pressure workplace		Capacity FAD*			Installed motor power		Noise level dB(A)	Weight workplace		Weight workplace Full feature	
		bar(e)	psig	l/s	m ³ /min	cfm	kW	hp		kg	lbs	kg	lbs
GA 30 ⁺	100	7.4	107	100	6.0	212	30	40	65	817	1801	898	1980
	125	9.1	132	91	5.4	192	30	40	65	817	1801	898	1980
	150	10.8	157	82	4.9	174	30	40	65	817	1801	898	1980
	175	12.5	181	75	4.5	158	30	40	65	817	1801	898	1980
GA 37	100	7.4	107	116	7.0	246	37	50	69	905	1995	820	1808
	125	9.1	132	108	6.5	229	37	50	69	905	1995	820	1808
	150	10.8	157	96	5.8	204	37	50	69	905	1995	820	1808
	175	12.5	181	87	5.2	185	37	50	69	905	1995	820	1808
GA 37 ⁺	100	7.4	107	120	7.2	255	37	50	65	905	1995	987	2176
	125	9.1	132	111	6.6	234	37	50	65	905	1995	987	2176
	150	10.8	157	100	6.0	212	37	50	65	905	1995	987	2176
	175	12.5	181	91	5.4	192	37	50	65	905	1995	987	2176
GA 45	100	7.4	107	139	8.3	294	45	60	72	894	1971	979	2158
	125	9.1	132	128	7.7	271	45	60	72	894	1971	979	2158
	150	10.8	157	118	7.1	250	45	60	72	894	1971	979	2158
	175	12.5	181	105	6.3	222	45	60	72	894	1971	979	2158
GA 45 ⁺	100	7.4	107	146	8.8	310	45	60	66	970	2138	1060	2337
	125	9.1	132	134	8.0	284	45	60	66	970	2138	1060	2337
	150	10.8	157	126	7.5	266	45	60	66	970	2138	1060	2337
	175	12.5	181	111	6.7	236	45	60	66	970	2138	1060	2337
GA 55	100	7.4	107	174	10.5	369	55	75	69	1229	2709	1329	2930
	125	9.1	132	154	9.3	327	55	75	69	1229	2709	1329	2930
	150	10.8	157	142	8.5	300	55	75	69	1229	2709	1329	2930
	175	12.5	181	128	7.7	272	55	75	69	1229	2709	1329	2930
GA 55 ⁺	100	7.4	107	184	11.0	390	55	75	67	1358	2994	1458	3214
	125	9.1	132	166	10.0	352	55	75	67	1358	2994	1458	3214
	150	10.8	157	141	8.5	299	55	75	67	1358	2994	1458	3214
GA 75	100	7.4	107	229	13.7	485	75	100	73	1259	2776	1359	2996
	125	9.1	132	200	12.0	424	75	100	73	1259	2776	1359	2996
	150	10.8	157	189	11.4	401	75	100	73	1259	2776	1359	2996
	175	12.5	181	169	10.1	358	75	100	73	1259	2776	1359	2996
GA 75 ⁺	100	7.4	107	248	14.9	525	75	100	69	1413	3115	1533	3380
	125	9.1	132	227	13.6	481	75	100	69	1413	3115	1533	3380
	150	10.8	157	204	12.3	433	75	100	69	1413	3115	1533	3380
	175	12.5	181	182	10.9	385	75	100	69	1413	3115	1533	3380
GA 90	100	7.4	107	289	17.4	613	90	125	74	1425	3142	1545	3406
	125	9.1	132	267	16.0	565	90	125	74	1425	3142	1545	3406
	150	10.8	157	250	15.0	530	90	125	74	1425	3142	1545	3406
	175	12.5	181	228	13.7	484	90	125	74	1425	3142	1545	3406

Please refer to the footnotes, reference conditions and FAD details of the 50 Hz versions.

GA 37-90 VSD (50/60 Hz versions)

Type	Working pressure		Capacity FAD*						Installed motor power		Noise level	Weight workplace		Weight workplace Full feature	
			l/s		m ³ /min		cfm								
	bar(e)	psig	min	max	min	max	min	max	kW	hp	dB(A)	kg	lbs	kg	lbs
GA 37 VSD	4	58	26.0	124	1.6	7.4	55	263	37	50	66/67	1042	2297	1127	2485
	7	102	26.0	123	1.6	7.4	55	260	37	50	66/67	1042	2297	1127	2485
	10	145	25.8	107	1.5	6.4	55	226	37	50	66/67	1042	2297	1127	2485
	13	189	40.3	87	2.4	5.2	85	185	37	50	66/67	1042	2297	1127	2485
GA 45 VSD	4	58	26.0	146	1.6	8.8	55	310	45	60	69/72	1100	2425	1190	2624
	7	102	26.0	145	1.6	8.7	55	307	45	60	69/72	1100	2425	1190	2624
	10	145	25.8	128	1.5	7.7	55	271	45	60	69/72	1100	2425	1190	2624
	13	189	40.3	107	2.4	6.4	85	226	45	60	69/72	1100	2425	1190	2624
GA 55 VSD	4	58	32.4	197	1.9	11.8	69	418	55	75	69/72	1380	3042	1480	3263
	7	102	26.0	175	1.6	10.5	55	371	55	75	69/72	1380	3042	1480	3263
	10	145	25.4	155	1.5	9.3	54	328	55	75	69/72	1380	3042	1480	3263
	13	189	37.0	129	2.2	7.7	78	273	55	75	69/72	1380	3042	1480	3263
GA 75 VSD	4	58	37.8	250	2.3	15.0	80	529	75	100	69/70	1534	3382	1654	3646
	7	102	37.4	250	2.2	15.0	79	530	75	100	69/70	1534	3382	1654	3646
	10	145	48.1	219	2.9	13.2	102	465	75	100	69/70	1534	3382	1654	3646
	13	189	58.3	182	3.5	10.9	124	386	75	100	69/70	1534	3382	1654	3646
GA 90 VSD	4	58	37.0	293	2.2	17.6	78	621	90	125	73/74	1534	3382	1654	3646
	7	102	39.4	292	2.4	17.5	84	619	90	125	73/74	1534	3382	1654	3646
	10	145	48.3	257	2.9	15.4	102	545	90	125	73/74	1534	3382	1654	3646
	13	189	59.4	214	3.6	12.9	126	454	90	125	73/74	1534	3382	1654	3646

*Unit performance measured according to ISO 1217, Annex E, Edition 4
 Maximum working pressure for VSD machines: 13 bar(e) (188 psig)

Oil-injected rotary screw compressors, 90-160 kW / 125-200 hp GA 90⁺-160⁺ / GA 110-160 VSD

Efficient, reliable and built to last, the GA 90⁺-160⁺ / GA 110-160 VSD compressors are designed to provide high-quality compressed air even under harsh conditions. Every GA is designed, manufactured and tested to comply with ISO 9001, ISO 14001 and ISO 1217. They use the latest generation of Atlas Copco's oil-injected screw element, ensuring a long and trouble-free life at the lowest possible operating cost. Engineered for reliable service, even in ambient temperatures up to 55°C/131°F and very harsh environmental circumstances, the GA takes reliability to a new level. Features such as Variable Speed Drive and energy recovery lead to significant reductions in energy use and cost.

CUSTOMER BENEFITS

- Highest reliability** – GA compressors incorporate the latest generation of Atlas Copco's state-of-the-art compression elements based on innovative asymmetric rotor profiles, a high-quality drive system and heavy-duty air inlet filters. All these components are selected to operate continuously in the toughest conditions and at ambient temperatures up to 55°C/131°F. Together they ensure long and trouble-free life of your compressor at the lowest operating cost.
- Maximum energy savings** – The innovative design of our GA compressors (including screw element, motor, VSD-controlled cooling fans etc.) enables you to achieve substantial savings in your energy costs and overall compressor lifecycle costs. The GA Variable Speed Drive (VSD) reduces energy costs by a further 35% on average by automatically adjusting the air supply to your air demand. And to reduce your costs even further, install the optional energy recovery system.
- Integrated air treatment** – The GA Full Feature with highly energy efficient integrated refrigerant dryer and air filter ensures the continuous supply of clean and dry air to extend the life of equipment, enhance system reliability and avoid costly downtime and production delays.
- Advanced control and monitoring** – To maximize efficiency and reliability, the Elektronikon® controls the main drive motor and regulates system pressure within a predefined and narrow pressure band. The Elektronikon® controller can be adapted to your specific needs with extra sensors, digital contacts, fieldbus, Internet and SMS communication functions. In combination with the ES multiple compressor controller, the operation of your complete compressor room is optimized.
- Easy installation** – The integrated design includes internal piping, coolers, motor, lubrication and control system: all supplied as a ready-to-use package. Installation is fault-free and commissioning time is low. Simply plug and run.



Type	Dimensions																	
	Air-cooled pack						Air-cooled full feature						Water-cooled pack & Full feature					
	L		W		H		L		W		H		L		W		H	
mm	inch	mm	inch	mm	inch	mm	inch	mm	inch	mm	inch	mm	inch	mm	inch	mm	inch	
GA 90 ⁺ -160 ⁺	2600	102	2000	79	2000	79	3200	126	2000	79	2000	79	2600	102	1630	64	2000	79
GA 110-160	2600	102	2000	79	2000	79	3200	126	2000	79	2000	79	2600	102	1632	64	2000	79
GA 110-160 VSD	3200	132	2000	79	2000	79	3800	150	2002	79	2347	92	3200	156	1630	64	2347	92

50 Hz versions

Type	Maximum working pressure				Capacity FAD ⁽¹⁾						Installed motor power		Noise level ⁽²⁾	Weight			
	Pack		Full Feature ⁽³⁾		Pack			Full Feature						Pack		Full Feature	
	bar(e)	psig	bar(e)	psig	l/s	m ³ /min	cfm	l/s	m ³ /min	cfm	kW	HP	dB(A)	kg	lb	kg	lb
GA 50 Hz																	
GA 90+ - 5.5	5.5	80	5.3	77	330	19.8	699	333	20.0	706	90	125	68	2917	6417	3310	7282
GA 90+ - 7.5	7.5	109	7.3	106	292	17.5	619	293	17.6	621	90	125	68	2917	6417	3310	7282
GA 90+ - 8.5	8.5	123	8.3	120	274	16.4	581	275	16.5	583	90	125	68	2897	6373	3290	7238
GA 90+ - 10	10	145	9.8	142	244	14.6	517	244	14.6	517	90	125	68	2709	5960	3102	6824
GA 90+ - 14	14	203	13.8	200	196	11.8	415	204	12.2	432	90	125	68	2709	5960	3102	6824
GA 110 - 7.5	7.5	109	7.3	106	342	20.5	725	343	20.6	727	110	150	69	2779	6114	3172	6978
GA 110 - 8.5	8.5	123	8.3	120	324	19.4	687	326	19.6	691	110	150	69	2779	6114	3172	6978
GA 110 - 10	10	145	9.8	142	297	17.8	629	297	21.4	754	110	150	69	2759	6070	3152	6934
GA 110+ - 5.5	5.5	80	5.3	77	401	24.1	850	404	24.2	856	110	150	69	2967	6527	3360	7392
GA 110+ - 7.5	7.5	109	7.3	106	356	21.4	754	357	21.4	756	110	150	69	2967	6527	3360	7392
GA 110+ - 8.5	8.5	123	8.3	120	337	20.2	714	338	20.3	716	110	150	69	2967	6527	3360	7392
GA 110+ - 10	10	145	9.8	142	306	23.8	839	306	18.4	648	110	150	69	2947	6483	3340	7348
GA 110+ - 14	14	203	13.8	200	245	14.7	519	252	15.1	534	110	150	69	2759	6070	3152	6934
GA 132 - 7.5	7.5	109	7.3	106	405	24.3	858	406	24.4	860	132	175	70	3134	6895	3527	7759
GA 132 - 8.5	8.5	123	8.3	120	385	23.1	816	386	23.2	818	132	175	70	3134	6895	3527	7759
GA 132 - 10	10	145	9.8	142	356	21.4	754	356	21.4	754	132	175	70	3114	6851	3507	7715
GA 132+ - 5.5	5.5	80	5.3	77	471	28.3	998	475	28.5	1006	132	175	70	3271	7196	3644	8017
GA 132+ - 7.5	7.5	109	7.3	106	424	25.4	898	425	25.5	901	132	175	70	3251	7152	3644	8017
GA 132+ - 8.5	8.5	123	8.3	120	401	24.1	850	402	24.1	852	132	175	70	3251	7152	3644	8017
GA 132+ - 10	10	145	9.8	142	368	22.1	780	368	22.1	780	132	175	70	3237	7121	3630	7986
GA 132+ - 14	14	203	13.8	200	295	17.7	625	301	18.1	638	132	175	70	3049	6708	3442	7572
GA 160 - 7.5	7.5	109	7.3	106	505	30.3	1070	506	30.4	1072	160	215	71	3361	7394	3754	8259
GA 160 - 8.5	8.5	123	8.3	120	480	28.8	1017	481	28.9	1019	160	215	71	3341	7350	3734	8215
GA 160 - 10	10	145	9.8	142	443	26.6	939	443	26.6	939	160	215	71	3341	7350	3734	8215
GA 160+ - 10	10	145	9.8	142	443	26.6	939	443	26.6	939	160	215	71	3341	7350	3734	8215
GA 160+ - 14	14	203	13.8	200	362	21.7	767	369	22.1	782	160	215	71	3327	7319	3720	8184

Type	Maximum working pressure ⁽⁴⁾				Capacity FAD ⁽¹⁾						Installed motor power		Noise level ⁽²⁾	Weight			
	Pack		Full Feature ⁽³⁾		Pack / Full Feature			Pack / Full Feature						Pack		Full Feature	
	bar(e)	psig	bar(e)	psig	l/s	m ³ /min	cfm	l/s	m ³ /min	cfm	kW	HP	dB(A)	kg	lb	kg	lb
GA VSD 50 Hz																	
GA 110 VSD - 8.5	3.5	72.5	5	72.5	96 - 412	5.8 - 24.7	203 - 873	110	150	71	3894	8585	4154	9158			
	7	102	7	102	93 - 369	5.6 - 22.1	198 - 782	110	150	71	3894	8585	4154	9158			
	8	116	8	116	92 - 348	5.5 - 20.9	194 - 737	110	150	71	3894	8585	4154	9158			
GA 110 VSD - 10	6	87	6	87	95 - 389	5.7 - 23.3	201 - 824	110	150	71	3894	8585	4154	9158			
	8	116	8	116	92 - 348	5.5 - 20.9	194 - 813	110	150	71	3894	8585	4154	9158			
	9.5	138	9.5	138	88 - 322	5.3 - 19.3	187 - 682	110	150	71	3894	8585	4154	9158			
GA 110 VSD - 14	9	131	9	131	90 - 330	5.4 - 19.8	190 - 699	110	150	71	3894	8585	4154	9158			
	10	145	10	145	87 - 314	5.2 - 18.8	184 - 665	110	150	71	3894	8585	4154	9158			
	13.5	196	13.5	196	74 - 256	4.5 - 15.4	157 - 542	110	150	71	3894	8585	4154	9158			
GA 132 VSD - 8.5	3.5	51	3.5	51	97 - 539	5.8 - 32.3	206 - 1142	132	175	68	3930	8646	4248	9346			
	7	102	7	102	93 - 457	5.6 - 27.4	197 - 968	132	175	68	3930	8646	4248	9346			
	8	116	8	116	91 - 435	5.5 - 26.1	193 - 922	132	175	68	3930	8646	4248	9346			
GA 132 VSD - 10	6	87	6	87	94 - 481	5.6 - 28.9	199 - 1019	132	175	68	3930	8646	4248	9346			
	8	116	8	116	91 - 435	5.5 - 26.1	193 - 922	132	175	68	3930	8646	4248	9346			
	9.5	138	9.5	138	89 - 403	5.3 - 24.2	189 - 854	132	175	68	3930	8646	4248	9346			
GA 132 VSD - 14	9	131	9	131	90 - 412	5.4 - 24.7	191 - 873	132	175	68	3930	8646	4248	9346			
	10	145	10	145	88 - 393	5.3 - 23.5	186 - 828	132	175	68	3930	8646	4248	9346			
	13.5	196	13.5	196	81 - 325	4.9 - 19.5	172 - 689	132	175	68	3930	8646	4248	9346			
GA 160 VSD - 8.5	3.5	51	3.5	51	97 - 572	5.8 - 34.3	206 - 1212	160	215	69	3930	8646	4248	9346			
	7	102	7	102	93 - 540	5.6 - 32.4	197 - 1144	160	215	69	3930	8646	4248	9346			
	8	116	8	116	91 - 515	5.5 - 30.9	193 - 1091	160	215	69	3930	8646	4248	9346			
GA 160 VSD - 10	6	87	6	87	94 - 566	5.5 - 34.0	199 - 1199	160	215	69	3930	8646	4248	9346			
	8	116	8	116	91 - 515	5.5 - 30.9	193 - 1091	160	215	69	3930	8646	4248	9346			
	9.5	138	9.5	138	89 - 480	5.3 - 28.8	189 - 1017	160	215	69	3930	8646	4248	9346			
GA 160 VSD - 14	9	131	9	131	90 - 492	5.4 - 29.5	191 - 1042	160	215	69	3930	8646	4248	9346			
	10	145	10	145	88 - 469	5.3 - 28.1	186 - 994	160	215	69	3930	8646	4248	9346			
	13.5	196	13.5	196	82 - 394	4.9 - 23.6	174 - 835	160	215	69	3930	8646	4248	9346			

⁽¹⁾ Unit Performance Measured according to ISO 1217, Edt.4, Annex C and E, 2009
 Measured according to ISO 2151: 2004 using ISO 9614/2 and maximum remaining aerosol 0.1 mg/m³
 Reference conditions:
 • Absolute Inlet pressure, specify bar(a), (e) 1 bar (14.5 psi)
 • Intake air temperature 20°C (68°F)
 • Cooling medium temperature 20°C (68°F)
⁽²⁾ Noise level*:
⁽³⁾ Maximum working pressure is reduced by 0.2 bar when integrated DD filter option is selected
 FAD is measured at the following working pressures:
 • 5.5 bar variants at 5 bar
 • 7.5 bar variants at 7 bar
 • 8.5 bar variants at 8 bar
 • 10 bar variants at 9.5 bar
 • 14 bar variants at 13.5 bar
⁽⁴⁾ Maximum working pressure for GA VSD - 8.5; 10; 14 bar (e)/GA VSD FF - 8.3; 9.8; 13.8 bar(e)
 Integrated dryer: Compressed air pressure dewpoint at dryer reference conditions 3°C
 Integrated DD filter: Particle removal down to 1 micron

60 Hz versions

Type	Maximum working pressure				Capacity FAD ⁽¹⁾						Installed motor power		Noise level ⁽²⁾	Weight			
	Pack		Full feature ⁽³⁾		Pack			Full feature			kW	HP		Pack		Full feature	
	bar(e)	psig	bar(e)	psig	l/s	m ³ /min	cfm	l/s	m ³ /min	cfm			kg	lb	kg	lb	
GA 60 Hz																	
GA 90+ - 75	5.5	80	5.3	77	343	20.6	727	346	20.8	733	90	125	68	2917	6417	3310	7282
GA 90+ - 100	7.4	107	7.2	104	302	18.1	640	303	18.2	642	90	125	68	2917	6417	3310	7282
GA 90+ - 125	9.1	132	8.9	129	274	16.4	581	275	16.5	583	90	125	68	2897	6373	3290	7238
GA 90+ - 150	10.9	158	10.7	155	239	14.3	506	239	14.3	506	90	125	68	2709	5960	3102	6824
GA 90+ - 200	14	203	13.5	196	205	12.3	434	213	12.8	451	90	125	68	2709	5960	3102	6824
GA 110 - 100	7.4	107	7.2	104	350	21.0	742	352	21.1	746	110	150	69	2779	6114	3172	6978
GA 110 - 125	9.1	132	8.9	129	320	19.2	678	322	19.3	682	110	150	69	2779	6114	3172	6978
GA 110 - 150	10.9	158	10.7	155	286	17.2	606	286	17.2	606	110	150	69	2759	6070	3152	6934
GA 110+ - 75	5.5	80	5.3	77	406	24.4	860	409	24.5	867	110	150	69	2967	6527	3360	7392
GA 110+ - 100	7.4	107	7.2	104	363	21.8	769	364	21.8	771	110	150	69	2967	6527	3360	7392
GA 110+ - 125	9.1	132	8.9	129	331	19.9	701	332	19.9	703	110	150	69	2967	6527	3360	7392
GA 110+ - 150	10.9	158	10.7	155	295	17.7	625	295	17.7	625	110	150	69	2947	6483	3340	7348
GA 110+ - 200	14	203	13.5	196	248	14.9	525	255	15.3	540	110	150	69	2759	6070	3152	6934
GA 132 - 100	7.4	107	7.2	104	403	24.2	854	405	24.3	858	132	175	70	3134	6895	3527	7759
GA 132 - 125	9.1	132	8.9	129	370	22.2	784	371	22.3	786	132	175	70	3134	6895	3527	7759
GA 132 - 150	10.9	158	10.7	155	336	20.2	712	336	20.2	712	132	175	70	3114	6851	3507	7715
GA 132+ - 75	5.5	80	5.3	77	467	28.0	990	471	28.3	998	132	175	70	3271	7196	3644	8017
GA 132+ - 100	7.4	107	7.2	104	421	25.3	892	422	25.3	894	132	175	70	3251	7152	3644	8017
GA 132+ - 125	9.1	132	8.9	129	385	23.1	816	386	23.2	818	132	175	70	3251	7152	3644	8017
GA 132+ - 150	10.9	158	10.7	155	346	20.8	733	346	20.8	733	132	175	70	3237	7121	3630	7986
GA 132+ - 200	14	203	13.5	196	290	17.4	614	296	17.8	627	132	175	70	3049	6708	3442	7572
GA 160 - 100	7.4	107	7.2	104	475	28.5	1006	477	28.6	1011	150	200	71	3361	7394	3754	8259
GA 160 - 125	9.1	132	8.9	129	437	26.2	926	438	26.3	928	150	200	71	3341	7350	3734	8215
GA 160 - 150	10.9	158	10.7	155	397	23.8	841	397	23.8	841	150	200	71	3341	7350	3734	8215
GA 160+ - 150	10.9	158	10.7	155	397	23.8	841	397	23.8	841	150	200	71	3341	7350	3734	8215
GA 160+ - 200	14	203	13.5	196	337	20.2	714	345	20.7	731	150	200	71	3327	7319	3720	8184

Type	Maximum working pressure ⁽⁴⁾				Capacity FAD ⁽¹⁾						Installed motor power		Noise level ⁽²⁾	Weight			
	Pack		Full feature ⁽³⁾		Pack / Full feature						kW	HP		dB(A)	Pack		Full feature
	bar(e)	psig	bar(e)	psig	l/s	m ³ /min	cfm	l/s	m ³ /min	cfm			kg		lb	kg	lb
GA VSD 60 Hz																	
GA 110 VSD - 125	3.5	72.5	5	72.5	96 - 412	5.7 - 24.5	203 - 867	110	148	71	3894	8585	4154	9158			
	7	102	7	102	93 - 371	5.6 - 22.2	198 - 786	110	148	71	3894	8585	4154	9158			
	8	116	8	116	90 - 336	5.4 - 20.0	191 - 711	110	148	71	3894	8585	4154	9158			
GA 110 VSD - 150	6	87	6	87	95 - 389	5.7 - 23.3	201 - 824	110	148	71	3894	8585	4154	9158			
	8	116	8	116	90 - 336	5.4 - 20.0	192 - 712	110	148	71	3894	8585	4154	9158			
	9.5	138	9.5	138	86 - 307	5.1 - 18.4	182 - 651	110	148	71	3894	8585	4154	9158			
GA 110 VSD - 200	9	131	9	131	90 - 330	5.3 - 19.8	190 - 699	110	148	71	3894	8585	4154	9158			
	10	145	10	145	86 - 307	5.2 - 18.4	182 - 650	110	148	71	3894	8585	4154	9158			
	13.5	196	13.5	196	74 - 256	4.4 - 15.3	157 - 543	110	148	71	3894	8585	4154	9158			
GA 132 VSD - 125	3.5	51	3.5	51	97 - 539	5.8 - 32.3	206 - 1142	132	175	68	3930	8646	4248	9346			
	6.9	100	6.9	100	93 - 459	5.6 - 27.5	197 - 973	132	175	68	3930	8646	4248	9346			
	8.6	125	8.6	125	90 - 422	5.4 - 25.2	191 - 890	132	175	68	3930	8646	4248	9346			
GA 132 VSD - 150	6	87	6	87	94 - 481	5.4 - 25.2	191 - 890	132	175	68	3930	8646	4248	9346			
	8.6	125	8.6	125	90 - 422	5.4 - 25.2	191 - 890	132	175	68	3930	8646	4248	9346			
	10.4	151	10.4	151	87 - 386	5.2 - 23.0	184 - 812	132	175	68	3930	8646	4248	9346			
GA 132 VSD - 200	9	131	9	131	90 - 414	5.4 - 24.7	191 - 873	132	175	68	3930	8646	4248	9346			
	10.4	151	10.4	151	87 - 386	5.2 - 23.0	184 - 812	132	175	68	3930	8646	4248	9346			
	13.5	196	13.5	196	81 - 325	4.9 - 19.5	172 - 689	132	175	68	3930	8646	4248	9346			
GA 160 VSD - 125	3.5	51	3.5	51	97 - 579	5.8 - 34.3	206 - 1212	160	215	69	3930	8646	4248	9346			
	6.9	100	6.9	100	93 - 543	5.6 - 32.6	197 - 1151	160	215	69	3930	8646	4248	9346			
	8.6	125	8.6	125	90 - 501	5.4 - 30.1	191 - 1062	160	215	69	3930	8646	4248	9346			
GA 160 VSD - 150	6	87	6	87	94 - 566	5.6 - 34.0	199 - 1199	160	215	69	3930	8646	4248	9346			
	8.6	125	8.6	125	90 - 501	5.4 - 30.1	191 - 1062	160	215	69	3930	8646	4248	9346			
	10.4	151	10.4	151	87 - 461	5.2 - 27.7	184 - 977	160	215	69	3930	8646	4248	9346			
GA 160 VSD - 200	9	131	9	131	90 - 492	5.4 - 29.5	191 - 1042	160	215	69	3930	8646	4248	9346			
	10.4	151	10.4	151	87 - 461	5.2 - 27.7	184 - 977	160	215	69	3930	8646	4248	9346			
	13.5	196	13.5	196	82 - 394	4.9 - 23.6	174 - 835	160	215	69	3930	8646	4248	9346			

⁽¹⁾ Unit Performance Measured according to ISO 1217, Ed. 4, Annex C and E, 2009

Reference conditions:

- Absolute Inlet pressure, specify bar(a), (e) 1 bar (14.5 psi)
- Intake air temperature 20°C (68°F)
- Cooling medium temperature 20°C (68°F)

⁽²⁾ Noise level*:

Measured according to ISO 2151: 2004 using ISO 9614/2

⁽³⁾ Maximum working pressure is reduced by 0.2 bar when integrated DD filter option is selected

⁽⁴⁾ Maximum working pressure for GA VSD - 8.5; 10; 14 bar (e)/ GA VSD FF - 8.3; 9.8; 13.8 bar(e)

Integrated dryer: Compressed air pressure dewpoint at dryer reference conditions 3°C

Integrated DD filter: Particle removal down to 1 micron and maximum remaining aerosol 0.1 mg/m³

FAD is measured at the following working pressures:

- 75 psi variants at 73 psi
- 100 psi variants at 100 psi
- 125 psi variants at 125 psi
- 150 psi variants at 150 psi
- 200 psi variants at 200 psi

Oil-injected rotary screw compressors 160-500 kW / 200-700 hp

GA 160⁺-500 (VSD)

Atlas Copco's GA 160⁺-500 (VSD) oil-injected rotary screw compressors are designed and built to provide the maximum free air delivery at the lowest energy costs. The robust design ensures your process will function continuously even in the harshest conditions such as temperatures up to 46°C/115°F.

CUSTOMER BENEFITS

- **Highest reliability** – Our GA 160⁺-500 (VSD) compressors incorporate a superior oil-injected screw element based on innovative asymmetric rotor profiles and a high-quality drive system. All components are selected to ensure a long and trouble-free life of your compressor at the lowest operating cost.
- **Reduced energy costs** – The GA Series' superior screw elements are designed to give the optimum combination of maximum Capacity FAD for low energy consumption. The state-of-the-art compressor element is powered by high efficiency/ NEMA EPart electric motors, contributing to maximum compressor package efficiency. Beside this, the GA 315 VSD can offer additional energy savings of on average 35% by automatically adjusting the motor speed to the air demand.

- **Integrated air treatment** – The GA Full Feature with highly energy-efficient integrated refrigerant dryer and air filter ensures the continuous supply of clean and dry air to extend the life of equipment, enhance system reliability and avoid costly downtime and production delays.
- **Advanced control monitoring** – To maximize efficiency and reliability, the Elektronikon[®] regulates system pressure within a predefined and narrow pressure band and can be adapted to your specific needs with extra sensors, digital contacts, fieldbus, Internet and SMS communication functions.
- **Easy installation** – The integrated design includes internal piping, coolers, motor, lubrication and control system: all supplied as a ready-to-use package. Installation is fault-free and commissioning time is low. Simply plug and run.
- **Service friendly** – With the selection of long lifetime consumables, the GA 160⁺-315 provide the highest availability. All service parts are easy and safe to access through large opening doors. Service time is reduced to a minimum to further optimize the life cycle cost of the compressor.



50 Hz versions air and water-cooled variants

Type	Maximum working pressure				Capacity FAD ⁽¹⁾			Installed motor power		Noise level ⁽²⁾	Weight			
	Pack		Full feature		Pack / Full feature			kW	hp		Pack		Full feature	
	bar(e)	psig	bar(e)	psig	l/s	m ³ /min	cfm			kg	lb	kg	lb	
GA 160*	5.5	80	5.3	77	621	37.2	1316	160		77	4213	9269	4670	10274
	7.5	109	7.3	106	538	32.2	1140	160		77	4213	9269	4670	10274
	8.5	123	8.3	120	498	29.8	1055	160		77	4213	9269	4670	10274
	10	145	9.8	142	448	26.9	949	160		77	4213	9269	4670	10274
GA 200	5.5	80	5.3	77	748	44.8	1585	200		78	4662	10256	5255	11561
	7.5	109	7.3	106	674	40.4	1428	200		77	4478	9852	4935	10857
	8.5	123	8.3	120	632	37.9	1339	200		77	4500	9900	4958	10908
	10	145	9.8	142	572	34.3	1212	200		77	4465	9823	4922	10828
GA 250	14	203	13.8	200	440	26.4	932	200		77	4450	9790	4907	10795
	7.5	109	7.3	106	833	49.9	1765	250		78	5145	11319	5737	12621
	8.5	123	8.3	120	773	46.3	1638	250		78	5145	11319	5601	12322
	10	145	9.8	142	709	42.5	1503	250		78	4682	10300	5139	11306
GA 315	14	203	13.8	200	575	34.5	1219	250		77	4667	10267	5124	11273
	7.5	109	7.3	106	1000	59.9	2119	315		78	5560	12232	6152	13534
	8.5	123	8.3	120	955	57.2	2024	315		78	5560	12232	6152	13534
	10	145	9.8	142	891	53.4	1888	315		78	5133	11293	5726	12597
GA 315	14	203	13.8	200	745	44.7	1579	315		78	5133	11293	5590	12298
	7.5	109	-	-	928	55.8	1966	315	420	72	7510	16559	-	-
	8.5	123	-	-	864	51.9	1831	315	420	72	7510	16559	-	-
GA 355	10	145	-	-	784	47.1	1661	315	420	72	7510	16559	-	-
	7.5	109	-	-	1050	63.1	2225	355	475	73	7760	17110	-	-
	8.5	123	-	-	969	58.2	2053	355	475	73	7760	17110	-	-
	10	145	-	-	890	53.5	1886	355	475	73	7760	17110	-	-
GA 400	13	189	-	-	731	43.9	1549	355	475	73	7760	17110	-	-
	7.5	109	-	-	1175	70.6	2490	400	535	74	8360	18433	-	-
	8.5	123	-	-	1109	66.6	2350	400	535	74	8360	18433	-	-
	10	145	-	-	1011	60.8	2142	400	535	74	8360	18433	-	-
GA 450	13	189	-	-	844	50.7	1788	400	535	74	8360	18433	-	-
	7.5	109	-	-	1298	78.0	2750	450	600	75	8360	18433	-	-
	8.5	123	-	-	1240	74.5	2628	450	600	75	8360	18433	-	-
	10	145	-	-	1144	68.8	2424	450	600	75	8360	18433	-	-
GA 500	13	189	-	-	960	57.7	2034	450	600	75	8360	18433	-	-
	7.5	109	-	-	1410	84.7	2988	500	670	76	7960	17551	-	-
	8.5	123	-	-	1347	80.9	2854	500	670	76	7960	17551	-	-
	10	145	-	-	1257	75.5	2664	500	670	76	7960	17551	-	-
	13	189	-	-	1068	64.2	2263	500	670	76	7960	17551	-	-

GA 500 figures are for medium voltage IP 23 motor

⁽¹⁾ Unit performance measured according to ISO 1217, Annex C, Edition 4.

Reference conditions:

Absolute inlet pressure 1 bar (14.5 psi).

Intake air temperature 20°C, 68°F.

⁽²⁾ A-weighted emission sound pressure level at the work station, Lp WSA (re 20 µPa) dB (with uncertainty 3 dB).

Values determined according to noise level test code ISO 2151 and noise measurement standard ISO 9614.

Pressure dew point of integrated refrigerant dryer at reference conditions: 2°C to 3°C, 36°F to 37°F.

⁽³⁾ Integrated dryer: Compressed air pressure dewpoint at dryer reference conditions 3°C.

FAD is measured at the following working pressures:

5.5 bar versions at 5 bar

7.5 bar versions at 7 bar

8.5 bar versions at 8 bar

10 bar versions at 9.5 bar

14 bar versions at 13.5 bar

60 Hz versions air and water-cooled variants

Type	Maximum working pressure				Capacity FAD ⁽¹⁾			Installed motor power		Noise level ⁽²⁾	Weight			
	Pack		Full feature		Pack / Full feature			kW	hp		Pack		Full feature	
	bar(e)	psig	bar(e)	psig	l/s	m ³ /min	cfm			kg	lb	kg	lb	
GA 160* - 75 psi	5.5	80	5.3	77	580	34.8	1229		200	77	4263	9379	4720	10384
GA 160* - 100 psi	7.4	107	7.2	104	511	30.6	1083		200	77	4263	9379	4720	10384
GA 160* - 125 psi	9.1	132	8.9	129	446	26.7	945		200	77	4250	9350	4707	10355
GA 160* - 150 psi	10.9	158	10.7	155	397	23.8	841		200	75	4250	9350	4707	10355
GA 200 - 75 psi	5.5	80	5.3	77	711	42.6	1507		250	77	4712	10366	5305	11671
GA 200 - 100 psi	7.4	107	7.2	104	633	37.9	1341		250	77	4443	9775	4900	10780
GA 200 - 125 psi	9.1	132	8.9	129	576	34.5	1221		250	77	4430	9746	4887	10751
GA 200 - 150 psi	10.9	158	10.7	155	505	30.3	1070		250	77	4430	9746	4887	10751
GA 200 - 200 psi	14	203	13.8	200	405	24.3	858		250	75	4415	9713	4872	10718
GA 250 - 100 psi	7.4	107	7.2	104	759	45.5	1608		300	78	5014	11031	5607	12335
GA 250 - 125 psi	9.1	132	8.9	129	694	41.6	1471		300	77	5014	11031	5471	12036
GA 250 - 150 psi	10.9	158	10.7	155	627	37.6	1329		300	77	4552	10014	5009	11020
GA 250 - 200 psi	14	203	13.8	200	526	31.5	1115		300	77	4537	9981	4994	10987
GA 315 - 100 psi	7.4	107	7.2	104	925	55.4	1960		350	78	5655	12441	6247	13743
GA 315 - 125 psi	9.1	132	8.9	129	855	51.2	1812		350	78	5655	12441	6247	13743
GA 315 - 150 psi	10.9	158	10.7	155	784	47.0	1661		350	78	5228	11502	5821	12806
GA 315 - 200 psi	14	203	13.8	200	667	40.0	1414		350	77	5228	11502	5685	12507
GA 315 VSD	4	58	4.0	58	854	51.2	1810		390	75	6165	13563	6615	14553
	7	102	7.0	102	847	50.8	1795		390	75	6165	13563	6616	14555
	10	145	9.9	144	710	42.6	1505		390	75	6165	13563	6617	14557
GA 355	7.4	107	-	-	1032	62.1	2191	335	450	73	7760/7860	17110/17331	-	-
	9.1	132	-	-	940	56.5	1992	335	450	73	7760/7860	17110/17331	-	-
	10.8	157	-	-	831	49.9	1761	335	450	73	7760/7860	17110/17331	-	-
	13.8	200	-	-	692	41.6	1466	335	450	73	7760/7860	17110/17331	-	-
GA 400	7.4	107	-	-	1128	67.9	2394	372	500	74	8360/7960	18433/17551	-	-
	9.1	132	-	-	1042	62.6	2208	372	500	74	8360/7960	18433/17551	-	-
	10.8	157	-	-	935	56.2	1981	372	500	74	8360/7960	18433/17551	-	-
	13.8	200	-	-	784	47.1	1661	372	500	74	8360/7960	18433/17551	-	-
GA 450	7.4	107	-	-	1334	80.4	2835	447	600	75	8360/8620	18433/19007	-	-
	9.1	132	-	-	1222	73.4	2589	447	600	75	8360/8620	18433/19007	-	-
	10.8	157	-	-	1126	67.7	2386	447	600	75	8360/8620	18433/19007	-	-
	13.8	200	-	-	943	56.7	1998	447	600	75	8360/8620	18433/19007	-	-
GA 500	7.4	107	-	-	1518	91.2	3217	522	700	76	7960	17551	-	-
	9.1	132	-	-	1404	84.4	2975	522	700	76	7960	17551	-	-
	10.8	157	-	-	1296	77.9	2746	522	700	76	7960	17551	-	-
	13.8	200	-	-	1114	66.9	2361	522	700	76	7960	17551	-	-

GA 500W figures are for medium voltage IP 23 motor. GA 355W - GA 400W - GA 450W: two different motor types used for IEC/CSA-UL at 60Hz low voltage

⁽¹⁾ Unit performance measured according to ISO 1217, Annex C, Edition 4.

Reference conditions:

- absolute Inlet pressure, specify bar(a), (e) 1 bar (14.5 psi)
- intake air temperature 20°C (68°F)

FAD is measured at the following working pressures:

- 7.5 bar variants at 7 bar
- 100 psi variants at 100 psi
- 8.5 bar variants at 8 bar
- 125 psi variants at 125 psi
- 10 bar variants at 9.5 bar
- 150 psi variants at 150 psi
- 13 bar variants at 12.5 bar

- 200 psi variants at 193 psi
- 20 bar variants at 19 bar
- 290 psi variants at 276 psi

⁽²⁾ A-weighted emission sound pressure level at the work station, Lp WSA (re 20 µPa) dB (with uncertainty 3 dB).

Values determined according to noise level test code ISO 2151 and noise measurement standard ISO 9614.

Pressure dew point of integrated refrigerant dryer at reference conditions: 2°C to 3°C, 36°F to 37°F.

⁽³⁾ Integrated dryer: Compressed air pressure dewpoint at dryer reference conditions 3°C.

Oil-injected rotary screw compressors, 110-200 kW / 150-270 hp GR 110-200

Atlas Copco's GR 110-200 oil-injected rotary screw compressors are ideal for high-pressure applications requiring a reliable air supply of 13 and 20 bar. The installation, operation and maintenance of these robust and reliable machines is kept simple. Their two-stage design ensures the most efficient operation at higher pressure. Our GR 110-200 compressors will cut your costs and enable smooth, continuous operation right across your production processes. You can choose from air- or water-cooled versions.

CUSTOMER BENEFITS

- **High reliability** – The two-stage compression element features an asymmetric rotor profile you can rely on. Thanks to the extremely reduced load on bearings, rotors and gears, the element lifetime is long, ensuring low wear and tear and reliability at the lowest operating cost.
- **Advanced control monitoring** – To maximize efficiency and reliability, the Elektronikon® controls the main drive motor and regulates system pressure within a predefined and narrow pressure band. The Elektronikon® controller can be adapted to your specific needs with extra sensors, digital contacts, fieldbus, Internet and SMS communication functions. In combination with the ES multiple compressor controller, the operation of your complete compressor room is optimized.
- **Easy installation** – The GR 110-200 is truly plug-and-play. Simply put the machine on a flat floor, connect the power line and the compressed air outlet, and push the start button.
- **Minimal maintenance** – GR 110-200 compressors are designed for trouble-free maintenance, with easily accessible oil and air filters and simple cooler cleaning procedures.

50 Hz versions

Type	Max. working pressure				Capacity FAD*			Installed motor power		Noise level	Weight			
	Pack		Full feature		Pack/ Full feature			kW	hp		Pack		Full feature	
	bar(e)	psig	bar(e)	psig	l/s	m³/min	cfm			kg	lb	kg	lb	
GA 315 VSD														
GA 315VSD	4	58	4	58	854	51.2	1810	290	390	75	6165	13563	6615	14553
	7	109	7	109	847	50.8	1795	290	390	75	6165	13563	6615	14553
	10	145	9.9	143	710	42.6	1505	290	390	75	6165	13563	6615	14553
GR 110 - 200 Two stage 13 bar														
GR 110	13	189	12.75	185	255	15.3	541	110	150	72	3140	6908	3470	7634
GR 132	13	189	12.75	185	308	18.5	653	132	175	75	3140	6908	3470	7634
GR 160	13	189	12.75	185	369	22.1	782	160	215	75	3547	7803	3877	8529
GR 200	13	189	12.75	185	437	26.2	926	200	270	76	3547	7803	3877	8529
GR 110 - 200 Two stage 20 bar														
GR 110	20	290	19.75	286	211	12.6	447	110	150	72	3140	6908	3470	7634
GR 200	20	290	19.75	286	385	23.1	816	200	270	75	3547	7803	3877	8529

* Unit performance measured according to ISO 1217, Annex C, Edition 4

Reference conditions:

- Absolute Inlet pressure, specify bar(a), (e) 1 bar (14.5 psi)
- Intake air temperature 20°C, 68°F

FAD is measured at the following working pressures:

- 5.5 bar versions at 5 bar
- 7.5 bar versions at 7 bar
- 8.5 bar versions at 8 bar
- 10 bar versions at 9.5 bar
- 14 bar versions at 13.5 bar
- 20 bar versions at 20 bar
- 75 psi variants at 73 psi
- 100 psi variants at 100 psi
- 125 psi variants at 125 psi
- 150 psi variants at 150 psi
- 200 psi variants at 200 psi
- 290 psi variants at 290 psi

** Noise level*

measured according to Pneurop/Cagi PN8NTC2.2 test code; tolerance ±3 dB(A)

Intergrated Dryer:

Pressure dewpoint of intergrated refrigerant dryer at reference conditions: 3 to 4°C

Intergrated Filter:

Partial removal down to 1 micron and maximum remaining oil aerosol of 0.1mg/m³

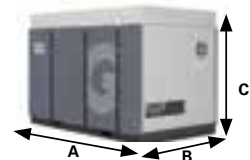

Type	Dimensions L x W x H					
	A		B		C	
	mm	inch	mm	inch	mm	inch
GA 160* - 315	3400	134	2000	79	2300	91
GA 315 - 500A*	5855	230.5	2120	83.4	2500	98.4
GA 315 - 500W*	4173	164.3	2120	83.4	2500	98.4
GA 315 VSD	4000	157.4	2120	83.4	2400	94.4
GR 110-200	2779	109.4	1886	74.3	1990	78.3

* W = Water-cooled

A = Air cooled

60 Hz versions

Type	Max. working pressure				Capacity FAD*			Installed motor power		Noise Level	Weight			
	Pack		Full feature		Pack/ Full feature						Pack		Full feature	
	bar(e)	psig	bar(e)	psig	l/s	m ³ /min	cfm	kW	hp	dB(A)	kg	lb	kg	lb
GA 315 VSD														
GA 315 VSD	4	58	4	58	854	51.2	1810	290	390	75	6165	13563	6615	14553
	7	109	7	109	847	50.8	1795	290	390	75	6165	13563	6615	14553
	10	145	9.9	143	710	42.6	1505	290	390	75	6165	13563	6615	14553
GR 110 - 200 Two stage 13 bar														
GR 110-200	13.8	200	13.55	196	261	15.6	541	110	150	72	3140	6908	3470	7634
GR 160-200	13.8	200	13.55	196	350	21.0	782	150	200	75	3547	7803	3877	8529
GR 200-290	13.8	200	13.55	196	442	26.5	926	185	250	78	3547	7803	3877	8529
GR 110 - 200 Two stage 20 bar														
GR 110-290	20	290	19.75	286	224	13.4	475	110	150	72	3140	6908	3470	7634
GR 200-290	20	290	19.75	286	384	23.0	814	200	270	78	3547	7803	3877	8529

* Unit performance measured according to ISO 1217, Annex C, Edition 4

Reference conditions:

- Absolute Inlet pressure, specify bar(a), (e) 1 bar (14.5 psi)
- Intake air temperature 20°C, 68°F

FAD is measured at the following working pressures:

- 5.5 bar versions at 5 bar
- 7.5 bar versions at 7 bar
- 8.5 bar versions at 8 bar
- 10 bar versions at 9.5 bar
- 14 bar versions at 13.5 bar
- 20 bar versions at 20 bar
- 75 psi variants at 73 psi
- 100 psi variants at 100 psi
- 125 psi variants at 125 psi
- 150 psi variants at 150 psi
- 200 psi variants at 200 psi
- 290 psi variants at 290 psi

** Noise level*

measured according to Pneurop/Cagi PN8NTC2.2 test code; tolerance ±3 dB(A)

Intergrated Dryer:

Pressure dewpoint of intergrated refrigerant dryer at reference conditions: 3 to 4°C

Intergrated Filter:

Partical removal down to 1 micron and maximum remaining oil aerosol of 0.1mg/m³

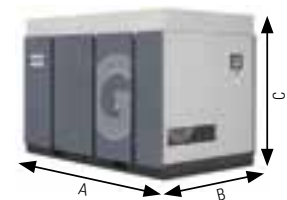

Type	Dimensions L x W x H					
	A		B		C	
	mm	inch	mm	inch	mm	inch
GA 200 - 315	3400	134	2000	79	2300	91
GA 315 - 500A*	5855	230.5	2120	83.4	2500	98.4
GA 315 - 500W*	4173	164.3	2120	83.4	2500	98.4
GA 315 VSD	4000	157.4	2120	83.4	2400	94.4
GR 110-200	2779	109.4	1886	74.3	1990	78.3

* W = Water-cooled

A = Air-cooled

Oil-lubricated high-pressure reciprocating compressors, up to 500 bar (a) (7250 psia), 37-150 kW B&D

Atlas Copco's B&D series of oil-lubricated reciprocating compressors meet your needs for high-pressure compressed air up to 500 bar(a). These flexible compressors offer capacities from 42 to 400 Nm³/h on certain configurations. Compact, with very low vibration levels and a sealed crankcase, B&D compressors are the perfect solution for the compression of air, nitrogen, natural gas, processed biogas, hydrogen, noble gases and other industrial gases.

CUSTOMER BENEFITS

- **High reliability** – The B&D piston technology offers field-proven ruggedness and reliability. Low compression ratios in the individual stages result in low thermal load for high reliability and high volumetric efficiency.
- **Easy installation** – Very compact, frame-mounted and incorporating anti-vibration pads, B&D compressors come as complete all-in packages. All designs are submitted as turnkey installations, virtually assuring the equipment is ready for operation soon after its arrival. This is a testament to their ease of installation.
- **A wide array of solutions** – B&D compressors are available from 1- to 5-stage configurations.
- **Low maintenance** – An advanced maintenance concept ensures short downtimes and long intervals between maintenance.
- **Compliance to ATEX**
- **Safety** – A sealed crankcase ensures no emission of gases to the atmosphere, even gases with a low molecular weight.



Technical specifications	Metric	Imperial
Working pressure	17 - 500 bar(e)	250 - 7250 psig
Installed motor power	15 - 165 kW	20 - 220 hp
Capacity	42 - 400 Nm ³ /h	25 - 250 scfm
Gases handled	air, nitrogen, helium, hydrogen, methane, bio-methane	

Oil-lubricated high pressure trunk-piston compressors, up to 351 bar(a) (5090 psia), 22-200 kW CU/CT/CN

Atlas Copco's CU/CT/CN is a complete series of oil-lubricated reciprocating compressors to meet your needs for high pressures up to 351 bar(a). Compact, with very low vibration levels and a sealed crankcase, CU/CT/CN compressors are the perfect solution for the compression of air, nitrogen, natural gas, processed biogas, hydrogen, noble gases and other industrial gases.

CUSTOMER BENEFITS

- **High level of safety** – A pressure-tight sealed crankcase ensures no emission of gases to the atmosphere, even gases with a low molecular weight.
- **High reliability** – The CU/CT/CN trunk-piston technology offers field-proven ruggedness and reliability. Low compression ratios in the individual stages result in low thermal load for high reliability and high volumetric efficiency.

- **Easy installation** – Very compact, frame-mounted and incorporating anti-vibration pads, CT/CU/CN compressors come as complete all-in packages that are simple to install without the need for foundations.
- **Low maintenance** – An advanced maintenance concept ensures short downtimes and long intervals between maintenance.
- **A wide array of solutions** – CU/CT compressors are available for Inlet pressure, from 1 to 19 bars, and up to 5-stage configurations. Discharge pressures are up to 350 bar for CU and for CT, while CN units are available for Inlet pressure, from atmosphere to 1.35 bar(a) for pressures up to 350 bar. They are suitable for diverse applications: CNG car/bus refueling stations, H2 refueling systems, bottle filling, air-blast circuit breakers. A specific range of CU/CT compressors has been designed for seismic applications, for installation onboard ships, with closed loop freshwater/seawater cooling and marine adaptations.
- **Compliance to ATEX**



Technical specifications	Metric	Imperial
Capacity FAD	4.2 - 472 l/s	4.2 - 472 l/s
Working pressure	1 - 351 bar(e)	14.5 - 5100 psig
Installed motor power	22 - 200 kW	40 - 275 hp
Capacity	15 - 1700 m ³ /h	8.8 - 1001 cfm
Inlet pressure	1 - 19 bar	14.5 - 275.5 psi
Gases handled	air, nitrogen, carbon monoxide, carbon dioxide, helium, hydrogen, argon, nitrous oxide, methane, biomethane	

Oil-lubricated gas screw compressors, 16 bar(a) (232 psia) GG-VSD

Atlas Copco's lubricated gas screw compressors meet your needs for methane and biomethane applications for pressures up to 16 bar(a) 232 psia. Single-stage, water-cooled and directly-driven, these compressors benefit from the latest technologies with exclusive bearing arrangements and variable speed drive. They comply with ATEX design requirements.

CUSTOMER BENEFITS

- Efficient capacity control** – Variable Speed Drive can regulate the capacity of the compressor to keep inlet and outlet pressures constant, depending on the application.
- High efficiency and consistent performance** – The GG-VSD's highly efficient rotor profile maximizes the flow and minimizes the horsepower. Direct drive through a flexible coupling means no gear losses or wasted energy.
- Sturdy design** – Superior shaft seal design and unparalleled precision manufacturing combine to ensure durable quality year after year. This makes the GG-VSD gas compressor the optimal solution for gas applications.
- Compact and easy to install** – This single stage compressor takes up minimal floor space. Frame-mounted, the GG-VSD gas compressor comes as a complete all-in package which can easily be integrated in your process.
- Compliance to ATEX**



Technical specifications	Metric	Imperial
Working pressure	16 bar (a)	232 psia
Installed motor power	90 - 132 kW	50 - 670 hp
Capacity	900 Nm ³ /h	530 scfm
Gases handled	processed biomethane	

Car and bus refueling stations S100/S750

Atlas Copco's S100/S750 car and bus modular refueling stations are compact high-performance installations designed for the refueling of passenger cars, indoor and light-duty vehicles, buses, heavy-duty trucks, ferries and special vehicles with natural gas (CNG/NGV), biogas and H₂.

CUSTOMER BENEFITS

- **Total solution** – With Atlas Copco you get total customer service, from a comprehensive study of the station layout to the delivery of the complete units
- **A wide array of solutions** – We provide fast-fill, low-fill or mother-daughter systems to meet your needs for standard to customized stations
- **Based on our high-performance compressors:**
 - CU/CT series – Lubricated trunk-piston technology, air- or water-cooled, with sealed crankcase – gas-tight up to 19 bar(a) (260 psig) – for capacities up to 1600 Nm³/h (1000 scfm).
 - DM series – Oil-free, hermetically sealed compressors – gas-tight up to 40 bar(a) (570 psig) – for capacities up to 210 Nm³/h (125 scfm).
- **Compact** – Available in concrete or sheet metal housing, their compact design is an asset on site
- **Modular** – Our standard stations are adapted to:
 - Up to 250 cars, 50 trucks or 25 buses per day
 - Up to 150 cars, 30 trucks or 15 buses per day
 - Up to 450 cars, 90 trucks or 45 buses per day



OIL-FREE COMPRESSORS

Oil-free air is used in all kinds of industries where air quality is paramount for the end-product and the production process. These applications include food and beverage processing, chemical and petrochemical processing, electronics manufacturing, medical sector, automotive paint spraying, textile manufacturing and many more.

By offering Class Zero certification on all oil-free compressors, Atlas Copco eliminates the risk of air contamination.

Oil-free compressed air

Atlas Copco is the first manufacturer of oil-free compressors that has achieved a compressed air quality of Class 0 in accordance with DIN-ISO 8573-1 – certified by the TÜV. The Z compressors offer compressed air that has never been into contact with oil.

This process eliminates any further filtering, reducing energy costs. In addition, there is no residual risk of contamination the product during its contact with the compressed air, safeguarding the quality of your end product and production process.

All our oil-free compressors have passed the TUV certification and are classified as Class 0 compressors.



We can provide a suitable oil-free solution for any application, any volume flow and (almost) any working pressure; from 0.4 bar, for example, for aerating sewage plants, up to 40 bar for producing PET bottles.

Our ZR/ZT compressors, for the most popular applications and pressures (up to 13 bar), are available with rotary technology for medium flow or with screw compression for improved performance. Air or water-cooled. They are available with speed regulation (VSD - Variable Speed Drive), if required, allowing you to save up 35% power on average, and the additional costs for the integrated frequency converter usually pay for themselves within one to two years. If you want, you can choose the Full Feature version (FF), which also has a desiccant dryer.

Or our ZBTurbos and ZS blower for applications with low pressure (from 0.4 to 1.7 bar working pressure). If you want to use pneumatic feed, ventilate biological clarifiers, or clean filters in power plants, these machines are the perfect solution. With the ZS⁺ blowers you can lower your power consumption, in comparison to conventional, belt-driven rotary piston blowers, by up to 40%, and the ZB centrifugal compressors with speed regulation save as much as 60% power compared to normal full-load/idle machines. This is because the turbo impellers are a very special patented development from Atlas Copco – with extremely high efficiency.

Our ZHTurbos are hard to beat when it comes to efficiency. They are suitable for heavy industry, where an extremely high amount of air with working pressures between 3.5 and 10.4 bar is continually required; for example, a few thousand to tens of thousands cubic meters per hour.



Industrial oil-free aluminum piston compressors, 1.5-7.5 kW / 2-10 hp
LF series

Atlas Copco's LF oil-free aluminium piston air compressors stand for exceptional reliability and extremely low operating costs and are virtually maintenance-free.

- LF | Page 55



Water-injected screw compressors, 15-55 kW / 20-75 hp
AQ 30-55 / 15-55 VSD

Atlas Copco's AQ water-injected screw compressors, available in water-cooled and air-cooled versions, meet your precise needs for pure, oil-free air while offering high-pressure capability and improved energy efficiency.

- AQ 30-55 / 15-55 VSD | Page 60



Compact oil-free piston compressors, 0.5-1.5 kW / 0.7-2 hp
LFX series

This small-capacity piston compressor provides you a reliable, oil-free solution for your low air demands.

- LFX 0.7-2.0 | Page 53



Oil-free rotary tooth compressors, 15-55 kW / 20-75 hp
ZT 15-22, ZR/ZT 30-45, ZR/ZT 22-37-55 VSD

Atlas Copco's ZR/ZT oil-free rotary tooth compressors meet your needs for pure oil-free air while offering wide pressure ranges and improved energy efficiency.

- ZT 15-22 | Page 64
- ZR/ZT 30-45 | Page 64
- ZR/ZT 22-37-55 VSD | Page 64



Oil-free scroll compressors, 1.5-22 kW / 2-30 hp
SF series

Atlas Copco's SF oil-free scroll compressors provide 100% oil-free for critical applications in industries such as R&D laboratories, hospitals, universities, dental applications, food & beverage .

- SF 1-22 | Page 57



Oil-free air- and water-cooled rotary screw compressors, 55-935 kW / 75-1253 hp
Z 55-900 (VSD)

Atlas Copco's Z 55-900 VSD Pack and Full Feature ranges power your production with ultimate reliability and efficiency under the harshest conditions.

- ZR 55-90 FF | Page 67
- ZR 75-90 VSD FF | Page 68
- ZR 110-750 | Page 69
- ZR 132-900 VSD | Page 75
- ZT 110-275 | Page 75
- ZT 132-315 VSD | Page 75



Oil-free centrifugal compressors, 355-2750 kW, 475-3500 hp
ZH / ZH⁺

Designed to save energy and guarantee reliability, Atlas Copco's ZH oil-free centrifugal compressors are provided as complete ready-to-integrate packages including internal piping, integrated coolers, motor, lubrication, inlet guide vanes, control system and 100% matched components.

- ZH / ZH⁺ | Page 76



Oil-free high-speed drive centrifugal compressors, 350 kW, 470 hp
ZH 350⁺

Atlas Copco's ZH 350⁺ oil-free centrifugal compressors are designed to save you energy. Operating at high speed and high efficiency, they are directly driven by a permanent magnet synchronous motor.

- ZH 350⁺ | Page 79



Energy recovery control unit for water-cooled oil-free air compressors from 90 to 900 kW.

ER 90-900

Atlas Copco energy recovery control units transfer the energy recovered in the cooling water of oil-free air compressors to your process.

- ER 90-900 | Page 80

Compact oil-free piston compressors, 0.5-1.5 kW / 0.7-2 hp

LFx 0.7 - 2.0

Atlas Copco's range of small-capacity piston compressors provides you a reliable, oil-free solution for your low air demands. The LFx ensures highly energy-efficient compressed air generation.

The LFx compressor's capacities range from from 1.02 up to 2.53 l/s (2.16 up to 5.36 cfm), with an optional 1- or 3-phase supply and a maximum working pressure of 10 bar (145 psi).



CUSTOMER BENEFITS

- **Flexible installation** –The LFx's small and compact design offer maximum installation flexibility. The LFx is both suitable for stand-alone use and integration in your OEM (Original Equipment Manufacturer) product.
- **High reliability** –Thanks to a unique, robust design and the optimal combination of quality materials, LFx compressors offer improved performance and extended product life.
- **Certified 100% oil-free air** – LFx piston compressors provide 100% pure, clean air, complying with ISO 8573-1 CLASS 0 (2010) certification. CLASS 0 means zero risk of contamination; zero risk of damaged or unsafe products; zero risk of losses from operational downtime; and zero risk of damaging your company's hard-won professional reputation. In 2006, Atlas Copco was the first manufacturer in the world to receive such certification for an oil-free compressor.
- **Easy maintenance** – All components and service points are easily accessible and your LFx requires no oil changes.
- **Quiet operation** –The LFx is standard outfitted with a silencing hood. These compressors achieve noise levels as low as 62 dB(A), allowing installation close at the point of use.



Variants	Type	Dimensions		Weight		Noise level*
		mm (L x W x H)	inch (L x W x H)	kg	lbs	
Powerbox	LFx 0.7/1.0	520 x 340 x 490	20.5 x 13.4 x 19.3	25	55	62-63
	LFx 1.5/2.0	520 x 340 x 490	20.5 x 13.4 x 19.3	29	63	63-64
Trolley (receiver 20 l)	LFx 0.7/1.0	520 x 440 x 824	20.5 x 17.3 x 32.4	44	97	62-64
	LFx 1.5/2.0	520 x 440 x 824	20.5 x 17.3 x 32.4	48	105	62-64
Tank mounted (vessel 50 l)	LFx 0.7/1.0	828 x 355 x 891	32.6 x 14 x 35	49	108	65-67
	LFx 1.5/2.0	828 x 355 x 891	32.6 x 14 x 35	53	117	65-67
Tank mounted (vessel 90 l)	LFx 0.7/1.0	960 x 364 x 973	37.8 x 14.3 x 38.3	64	141	65-67
	LFx 1.5/2.0	960 x 364 x 973	37.8 x 14.3 x 38.3	68	149	65-67

* Unit performance measured according to ISO 1217, Ed. 4, 2009, Annex C.

**Mean Noise level* measured according to ISO 2151/Pneurop/Cagi PN8NTC2 test code; tolerance 2 dB(A).

Reference conditions:

- Absolute Inlet pressure, specify bar(a), (e) 1 bar (14.5 psi)
 - Intake air temperature 20°C, 68°F
- FAD is measured at 7 bar.

Type	Max. working pressure		Capacity FAD			Installed motor power	
	bar	psig	l/s	m ³ /min	cfm	kW	hp
LFx 0.7	10	145	1.02	0.06	2.16	0.55	0.7
LFx 1.0	10	145	1.38	0.08	2.92	0.75	1
LFx 1.5	10	145	2.07	0.18	4.38	1.1	1.5
LFx 2.0	10	145	2.53	0.12	5.36	1.5	2

Type	Max. working pressure		Capacity FAD			Installed motor power	
	bar	psig	l/s	m ³ /min	cfm	kW	hp
LFx 0.7	10	145	1.35	0.081	2.86	0.55	0.7
LFx 1.0	10	145	1.46	0.087	3.09	0.75	1
LFx 1.5	10	145	2.39	0.14	5.06	1.1	1.5

Dimensions standard versions:

LFx 0.7-1.0

H: 800 mm, 31.5"
W: 550 mm, 21.7"
D: 525 mm, 20.7"

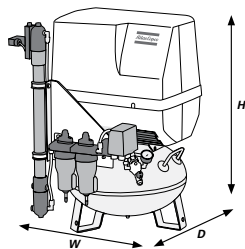

LFx 1.5-2.0

H: 890 mm, 35"
W: 828 mm, 32.6"
D: 505 mm, 19.9"

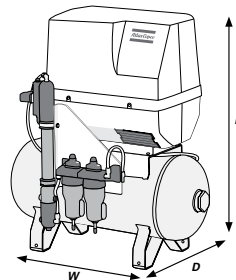

Industrial oil-free aluminum piston compressors, 1.5-7.5 kW / 2-10 hp

LF

Looking for a durable, high-performance compressed air solution for your specific industrial application? Atlas Copco's LF oil-free aluminium piston air compressors stand for exceptional reliability and extremely low operating costs and are virtually maintenance-free. LF compressors are 100% oil-free, so are ideal for your applications where oil can not be tolerated. Incorporating state-of-the-art technology, LF compressors deliver the lowest operating temperatures in the industry while offering superb quality air. High-quality materials ensure reliable performance and extra long life. The LF range is suitable for stand-alone use or easy integration in your OEM product. Also where maintenance-free compressed air is required, LF units are the best solution.

CUSTOMER BENEFITS

- **High reliability** – Thanks to a unique, robust design and the optimal combination of quality materials, LF compressors offer improved performance and extended product life.
- **Certified 100% oil-free air** – LF compressors provide 100% pure, clean air, complying with ISO 8573-1 CLASS 0 (2010) certification. CLASS 0 means zero risk of contamination; zero risk of damaged or unsafe products; zero risk of losses from operational downtime; and zero risk of damaging your company's hard-won professional reputation. In 2006, Atlas Copco was the first manufacturer in the world to receive such certification for an oil-free compressor.
- **Easy maintenance** – All components and service points are easily accessible.
- **Low running costs** – Operational costs are limited over a long product lifetime.
- **Saving floor space** – The compressor block which is directly coupled to the motor is manufactured using lightweight materials and provides excellent cooling characteristics: ideal for integration with limited space requirements.





LF basic unit



LF Pack-Version
Base frame with acoustic hood



LF Trolley
mobile versions with either electric or gasoline engine



LF unit
tank mounted

Type	Maximum working pressure*		Capacity FAD (50 Hz)			FAD at normal working pressure and 1,800 rpm (60 Hz)			Installed recommended power		Noise level dB(A)**	
	bar(e)	psig	l/s	m ³ /min	cfm	l/s	m ³ /min	cfm	kW	hp	Unsilenced	Base-mounted, silenced
10 BAR LF												
LF 2-10	10	145	3.1	0.19	6.6	3.6	0.22	7.6	1.5	2	82/84	67/69
LF 3-10	10	145	4	0.24	8.5	4.6	0.28	9.7	2.2	3	83/85	68/70
LF 5-10	10	145	8.2	0.49	17.4	9.1	0.55	19.3	4	5.5	83/85	68/70
LF 7-10	10	145	11	0.66	23.3	12	0.72	25.4	5.5	7.5	84/86	72/74
LF 10-10	10	145	15.5	0.93	32.8	18.2	1.1	38.9	7.5	10	86/88	74/76

* Unit performance measured according to ISO 1217, Ed. 4, 2009, Annex C.

** Mean Noise level* measured at a distance of 1 m according to ISO 2151/Pneurop/Cagi PN8NTC2 test code; tolerance 3 dB(A).

Reference conditions:

- Absolute Inlet pressure, specify bar(a), (e) 1 bar (14.5 psi).
 - Intake air and coolant temperature 20°C, 68°F.
 - 20 bar versions at 20 bar.
 - 30 bar versions at 30 bar.
- Receiver size 10, 15 & 20 bar (218, 290 or 435 psi) versions:
90, 250 & 475 l (24, 66 & 125 US gallon)

FAD is measured at the following working pressures:

- 10 bar versions at 7 bar.
 - 15 bar versions at 12 bar.
- Standard voltages available:
50 Hz: 1 ph 230 V, 3 ph 230, 400, 500 V
60 Hz: 1 ph 230 V, 3 ph 230, 460, 380, 575 V

Oil-free scroll compressors, 1.5-22 kW / 2-30 hp

SF 1-22

Atlas Copco's SF oil-free scroll compressors provide 100% oil-free for critical applications in industries such as R&D laboratories, hospitals, universities, dental applications, food & beverage. These ISO 8573-1 CLASS 0 certified compressors are easy to operate and maintain, and have a minimal footprint to save space in your facility.

SF compressors eliminate the risks of oil contamination while providing an efficient, reliable and highly cost-effective source of pure oil-free air.

CUSTOMER BENEFITS

- **Certified 100% oil-free air** – SF compressors provide 100% pure, clean air, complying with ISO 8573-1 CLASS 0 (2010) certification. CLASS 0 means zero risk of contamination; zero risk of damaged or unsafe products; zero risk of losses from operational downtime; and zero risk of damaging your company's hard-won professional reputation. In 2006, Atlas Copco was the first manufacturer in the world to receive such certification for an oil-free compressor.
- **Extremely quiet operation** – The low speed of the scroll compression elements ensures that the SF scroll compressors are exceptionally quiet. SF units are WorkPlace Air System™ compressors, making them suitable for installation in any working environment.
- **Energy efficiency** – SF scroll compressors are ideal for applications where flexibility and energy efficiency are crucial. Unloaded power consumption is eliminated thanks to the simple start/stop control. Advanced scroll technology guarantees an optimal free air delivery and low duty cycle applications.
- **Low maintenance** – SF scroll compressors stand for simplicity and reliability. The scroll design has a minimal number of moving parts, ensuring a long operating life with a minimum number of service interventions.
- **Advanced control and monitoring** – To maximize efficiency and reliability on multi-module SFs, the Elektronikon® controls the main drive motor and regulates system pressure within a predefined and narrow pressure band. The Elektronikon® controller can be adapted to your specific needs with extra sensors, digital contacts, fieldbus, Internet and SMS communication functions. In combination with the ES multiple compressor controller, the operation of your complete compressor room is optimized.

Special design / options the SF series



SF 4Twin-Version (T)
receiver mounted with two SF units and
acoustic enclosure and adsorption dryers



SF 4 Standard
receiver mounted
with acoustic
enclosure

SF 4 Skid version
on base frame with
acoustic enclosure



SF 4 full-feature
version (FF) with
an integrated
membrane dryer
and soundproof
canopy. Receiver
mounted.



SF Multicore 6-22 FF
oil-free scroll compressors



SF 15 FF

SF Multicore – flexibility through modular design

The Scroll Multicore concept further enhances the performance of the Scroll technology. Two to four compressor modules (PM version) are integrated into one unit and offer all the advantages of a modular system. For dry compressed air, a refrigerant dryer can be integrated as well as 2–4 compressor modules (PM/FF versions).



SF 8 FF



The specially designed software makes optimal use of the additional advantages which result from the Multicore concept: sequential operation, stageless volume flow regulation for low power consumption – while the individual modules are controlled by software like a single SF aggregate.

Type	Max. working pressure		Capacity FAD*			Installed motor power		Noise level**	Dimensions L x W x H		Weight	
	bar(e)	psig	l/s	m ³ /min	cfm	kW	hp	dB(A)	mm	inch	kg	lbs
Skid versions												
SF 1	8	116	2.7	0.16	5.7	1.5	2	65	800 x 600 x 540	31.5 x 23.6 x 21.3	105	232
	10	145	2.1	0.13	4.4	1.5	2	65			105	232
SF 2	8	116	4.0	0.24	8.5	2.2	3	67	(Receiver mounted)	(Receiver mounted)	110	243
	10	145	3.4	0.20	7.2	2.2	3	67			110	243
SF 4	8	116	6.6	0.40	14.0	3.7	5	68	1267 x 600 x 1154	49.9 x 23.6 x 45.4	120	265
	10	145	5.60	0.30	11.9	3.7	5	68			120	265
Skid versions – duplex tank mounted												
SF 6T	8	116	10.6	0.64	22.5	5.9	8	72	2043 x 600 x 1154	80.4 x 23.6 x 45.4	365	805
	10	145	9.0	0.54	19.1	5.9	8	72			365	805
SF 8T	8	116	13.2	0.80	28.0	7.4	10	73			375	827
	10	145	11.2	0.67	23.7	7.4	10	73			375	827
Fully silenced – WorkPlace air system™												
SF 1	8	116	2.7	0.16	5.7	1.5	2	53	590 x 600 x 850	23.2 x 23.6 x 33.5	97	214
	10	145	2.1	0.13	4.4	1.5	2	53			97	214
SF 2	8	116	4.0	0.24	8.5	2.2	3	55			97	214
	10	145	3.4	0.20	7.2	2.2	3	55			97	214
SF 4	8	116	6.6	0.40	14.0	3.7	5	57			102	225
	10	145	5.6	0.34	11.9	3.7	5	57			102	225
SF 6	8	116	10.4	0.62	22.0	5.9	8	63	1450 x 750 x 1040	57.1 x 29.5 x 40.9	340	750
	10	145	8.8	0.53	18.6	5.9	8	63			340	750
SF 8	8	116	13.4	0.80	28.4	7.4	10	63			345	761
	10	145	11.3	0.68	23.9	7.4	10	63			345	761
SF 11	8	116	20.2	1.21	42.8	11	15	63	1450 x 750 x 1844	57.1 x 29.5 x 72.6	480	1058
	10	145	17.0	1.00	36.0	11	15	63			480	1058
SF 15	8	116	26.4	1.58	55.0	15	20	63			560	1235
	10	145	22.8	1.37	48.3	15	20	63			560	1235
SF 17 M	8	116	30.6	1.8	64.7	17	23	64	1630 x 750 x 1850	64 x 29.4 x 72.7	572	1258
SF 22 M	8	116	40.6	2.4	85.6	22	30	65			662	1456
SF 11 VZV	8	116	9.7	0.6	20.5	5.5	7	63			503	1107
SF 15 DM	8	116	13.2	0.8	27.9	7.5	10	63			564	1241
SF 22 DM	8	116	19.5	1.2	41.1	11	15	65			683	1503

* Unit performance measured according to ISO 1217, Ed. 4, 2009, Annex C.

** Noise level* measured at a distance of 1m according to Pneurop/Cagi PN8NTC2 test code.

Reference conditions:

- absolute Inlet pressure, specify bar(a), (e) 1 bar (14.5 psig)
- intake air temperature 20°C (68°F)

Water-injected screw compressors, 15-55 kW / 20-75 hp AQ 30-55 / 15-55 VSD

Atlas Copco's AQ water-injected screw compressors, available in water-cooled and air-cooled versions, meet your precise needs for pure, oil-free air while offering high-pressure capability and improved energy efficiency. Developed especially for applications demanding the highest levels of purity, such as pharmaceutical production, food processing and critical electronics, AQ compressors eliminate the risks of oil contamination as well as the resulting extra costs. They ensure consistent 100% oil-free air while you benefit from lower operating and maintenance costs with an ISO 8573-1 CLASS 0 (2010) certified compressor.

CUSTOMER BENEFITS

- **High efficiency** – Thanks to the superior cooling capability of water which ensures that the heat is removed efficiently at the source, more air per kW of power is generated. Energy savings of 35% on average are possible with the Variable Speed Drive versions:

- Load/no load transition losses are eliminated.
- Precise pressure control allows a tighter pressure band and a lower average working pressure, resulting in reduced energy consumption.
- **Certified 100% oil-free air** – AQ compressors provide 100% pure, clean air, complying with ISO 8573-1 CLASS 0 (2010) certification. CLASS 0 means zero risk of contamination; zero risk of damaged or unsafe products; zero risk of losses from operational downtime; and zero risk of damaging your company's hard-won professional reputation. In 2006, Atlas Copco was the first manufacturer in the world to receive such certification for an oil-free compressor.
- **Quiet operation** – AQ compressors are supplied in a sound-insulated canopy, thus avoiding the need for a separate compressor room and allowing installation in most working environments.
- **Advanced control and monitoring** – To maximize efficiency and reliability, the Elektronikon® controls the main drive motor and regulates system pressure within a predefined and narrow pressure band. The Elektronikon® controller can be adapted to your specific needs with extra sensors, digital contacts, fieldbus, Internet and SMS communication functions. In combination with the ES multiple compressor controller, the operation of your complete compressor room is optimized.



AQ 55 VSD FF



At the heart of the AQ series is a unique screw element with water-injection for a highly efficient, almost isothermal compression.

The polymer ceramic rotors with an optimized rotor profile are guided by water-lubricated bearings; this ensures that the compressor element is not contaminated with oil, in order to produce oil-free air.

Rotors

A highly efficient compression process is achieved thanks to the polymer ceramic rotors with an optimized profile. The combination of corrosion-free, highly-efficient raw materials and the smooth water lubrication results in a much longer service life.

Element housing

The strength and long

service life are achieved by using an element casing made of aluminum bronze, which eliminates the risk of corrosion inside the housing.

Element bearings

Using hydrodynamic bearings ensures a long service life, because there are no friction points in the bearing; it just glides on a water film and does not need any oil or lubrication.

50 Hz versions

Type	Max. working pressure (bar(e)/psig)		Capacity FAD (*)			Installed motor power		Noise level(**)	Weight (kg/lbs)		
	Pack	Full feature	l/s	m ³ /min	cfm	kW	hp		Pack	Full feature	
air-COOLED											
AQ 30	7.5	7.5 / 109	7.25 / 105	84.9	5.1	180.1	30	40	68	1226 / 2703	1320 / 2910
	10	10 / 145	9.75 / 141	68.3	4.1	144.8	30	40	68	1226 / 2703	1320 / 2910
	13	13 / 189	12.75 / 185	53	3.2	113	30	40	68	1226 / 2703	1320 / 2910
AQ 37	7.5	7.5 / 109	7.25 / 105	102	6.1	215.4	37	50	69	1298 / 2862	1395 / 3075
	10	10 / 145	9.75 / 141	86.4	5.2	183.6	37	50	69	1298 / 2862	1395 / 3075
	13	13 / 189	12.75 / 185	69.2	4.2	148.3	37	50	69	1298 / 2862	1395 / 3075
AQ 45	7.5	7.5 / 109	7.25 / 105	121.4	7.3	257.8	45	60	71	1321 / 2912	1416 / 3122
	10	10 / 145	9.75 / 141	98.1	5.9	208.4	45	60	71	1321 / 2912	1416 / 3122
	13	13 / 189	12.75 / 185	82.2	4.9	173	45	60	71	1321 / 2912	1416 / 3122
AQ 55	7.5	7.5 / 109	7.25 / 105	139.1	8.4	296.6	55	75	72	1378 / 3038	1497 / 3300
	10	10 / 145	9.75 / 141	118.1	7.1	250.7	55	75	72	1378 / 3038	1497 / 3300
	13	13 / 189	12.75 / 185	98.4	5.9	208.4	55	75	72	1378 / 3038	1497 / 3300
WATER-COOLED											
AQ 30	7.5	7.5 / 109	7.25 / 105	88.5	5.3	187.5	30	40	65	1121 / 2471	1215 / 2679
	10	10 / 145	9.75 / 141	71.2	4.3	151.8	30	40	65	1121 / 2471	1215 / 2679
	13	13 / 189	12.75 / 185	55	3.3	116.5	30	40	65	1121 / 2471	1215 / 2679
AQ 37	7.5	7.5 / 109	7.25 / 105	107.1	6.4	226.9	37	50	66	1193 / 2630	1290 / 2844
	10	10 / 145	9.75 / 141	91.2	5.5	194.2	37	50	66	1193 / 2630	1290 / 2844
	13	13 / 189	12.75 / 185	72.9	4.4	155.4	37	50	66	1193 / 2630	1290 / 2844
AQ 45	7.5	7.5 / 109	7.25 / 105	128.5	7.7	272.3	45	60	67	1216 / 2681	1313 / 2895
	10	10 / 145	9.75 / 141	108	6.5	230	45	60	67	1216 / 2681	1313 / 2895
	13	13 / 189	12.75 / 185	89.9	5.4	190.7	45	60	67	1216 / 2681	1313 / 2895
AQ 55	7.5	7.5 / 109	7.25 / 105	152.7	9.2	323.6	55	75	68	1273 / 2806	1392 / 3069
	10	10 / 145	9.75 / 141	131.2	7.9	279	55	75	68	1273 / 2806	1392 / 3069
	13	13 / 189	12.75 / 185	109	6.5	230	55	75	68	1273 / 2806	1392 / 3069

(*)Unit performance measured according to ISO 1217, Ed. 4, 2009, Annex C.

Reference conditions:

- Absolute Inlet pressure, specify bar(a), (e) 1 bar (14.5 psi)
- Intake air temperature 20°C (68°F)

(**)Noise level* measured at a distance of 1m according to Pneuop/Cagi PN8NTC2 test code: 3dB()

FAD is measured at the following working pressure:

- 7 bar versions at 7.5 bar(e)

AQ 37-55 VSD

H: 1840 mm, 72"
W: 965 mm, 40"
L: 2435 mm, 96"



60 Hz versions

Type	Max. working pressure (bar(e)/psig)			Capacity FAD ⁽¹⁾			Installed motor power		Noise level*	Weight (kg/lbs)	
	-	Full feature		l/s	m ³ /min	cfm	kW	hp		Pack	Full feature
AIR-COOLED											
AQ 30	7.4	7.4 / 107	7.15 / 104	87.8	5.3	187.2	30	40	68	1226 / 2703	1320 / 2910
	9.1	9.1 / 132	8.85 / 128	78.7	4.7	166.1	30	40	68	1226 / 2703	1320 / 2910
	10.8	10.8 / 157	10.55 / 153	67.5	4.1	144.8	30	40	68	1226 / 2703	1320 / 2910
	12.5	12.5 / 181	12.25 / 178	59.2	3.6	127.1	30	40	68	1226 / 2703	1320 / 2910
AQ 37	7.4	7.4 / 107	7.15 / 104	105.5	6.3	222.5	37	50	69	1298 / 2862	1395 / 3075
	9.1	9.1 / 132	8.85 / 128	87.7	5.3	187.2	37	50	69	1298 / 2862	1395 / 3075
	10.8	10.8 / 157	10.55 / 153	83	5	176.6	37	50	69	1298 / 2862	1395 / 3075
	12.5	12.5 / 181	12.25 / 178	76.1	4.6	162.4	37	50	69	1298 / 2862	1395 / 3075
AQ 45	7.4	7.4 / 107	7.15 / 104	122.4	7.3	257.8	45	60	71	1321 / 2912	1416 / 3122
	9.1	9.1 / 132	8.85 / 128	103	6.2	219.1	45	60	71	1321 / 2912	1416 / 3122
	10.8	10.8 / 157	10.55 / 153	96	5.8	204.8	45	60	71	1321 / 2912	1416 / 3122
	12.5	12.5 / 181	12.25 / 178	88.7	5.3	187.2	45	60	71	1321 / 2912	1416 / 3122
AQ 55	7.4	7.4 / 107	7.15 / 104	146.8	8.8	310.8	55	75	72	1378 / 3038	1497 / 3300
	9.1	9.1 / 132	8.85 / 128	118.2	7.1	250.7	55	75	72	1378 / 3038	1497 / 3300
	10.8	10.8 / 157	10.55 / 153	119.6	7.2	254.3	55	75	72	1378 / 3038	1497 / 3300
	12.5	12.5	12.25	106	6.4	226	55	75	72	1378 / 3038	1497 / 3300
WATER-COOLED											
AQ 30	7.4	7.4 / 107	7.15 / 104	91.8	5.5	194.2	30	40	65	1121 / 2471	1215 / 2679
	9.1	9.1 / 132	8.85 / 128	82.7	5	176.6	30	40	65	1121 / 2471	1215 / 2679
	10.8	10.8 / 157	10.55 / 153	70.4	4.2	148.3	30	40	65	1121 / 2471	1215 / 2679
	12.5	12.5 / 181	12.25 / 178	61.7	3.7	130.7	30	40	65	1121 / 2471	1215 / 2679
AQ 37	7.4	7.4 / 107	7.15 / 104	111.3	6.7	236.6	37	50	66	1193 / 2630	1290 / 2844
	9.1	9.1 / 132	8.85 / 128	93	5.6	197.8	37	50	66	1193 / 2630	1290 / 2844
	10.8	10.8 / 157	10.55 / 153	87.5	5.3	187.2	37	50	66	1193 / 2630	1290 / 2844
	12.5	12.5 / 181	12.25 / 178	80.7	4.8	169.5	37	50	66	1193 / 2630	1290 / 2844
AQ 45	7.4	7.4 / 107	7.15 / 104	134	8	282.5	45	60	67	1216 / 2681	1313 / 2895
	9.1	9.1 / 132	8.85 / 128	115.2	6.9	243.7	45	60	67	1216 / 2681	1313 / 2895
	10.8	10.8 / 157	10.55 / 153	104.2	6.3	222.5	45	60	67	1216 / 2681	1313 / 2895
	12.5	12.5 / 181	12.25 / 178	97.8	5.9	208.4	45	60	67	1216 / 2681	1313 / 2895
AQ 55	7.4	7.4 / 107	7.15 / 104	161.7	9.7	342.6	55	75	68	1273 / 2806	1392 / 3069
	9.1	9.1 / 132	8.85 / 128	132.7	8	282.5	55	75	68	1273 / 2806	1392 / 3069
	10.8	10.8 / 157	10.55 / 153	131.5	7.9	279.1	55	75	68	1273 / 2806	1392 / 3069
	12.5	12.5	12.25	118.7	7.1	250.7	55	75	68	1273 / 2806	1392 / 3069

AQ 37-55 VSD

Type	Max. working pressure ⁽¹⁾		Capacity FAD ⁽²⁾			Installed motor power		Noise level ⁽³⁾	Weight (kg/lbs)	
	bar(e)	psig	l/s	m ³ /min	cfm	kW	hp		Pack	Full Feature
AIR-COOLED										
AQ 37 VSD 13 ⁽¹⁾	13	175	42.0 – 104.0	2.5 – 6.2	89.0 – 220.4	37	50	69	1195 / 2635	1306 / 2879
AQ 55 VSD 13 ⁽¹⁾	13	175	42.3 – 154.9	2.5 – 9.3	89.6 – 328.2	55	75	72	1195 / 2635	1314 / 2897
WATER-COOLED										
AQ 37 VSD 13 ⁽¹⁾	13	175	42.0 – 108.0	2.5 – 6.2	89.0 – 228.8	37	50	66	1090 / 2403	1201 / 2648
AQ 55 VSD 13 ⁽¹⁾	13	175	41.9 – 160.9	2.5 – 9.3	88.8 – 340.9	55	75	69	1090 / 2403	1209 / 2665

⁽¹⁾ Full-Feature units max. working pressure 12.5 bar(e)/181 psig.

⁽²⁾ Stated performance according ISO 1217, Ed. 4, 2009, Annex E.

⁽³⁾ Mean sound level according to ISO2151, tolerance 3 dB(A).

Oil-free rotary tooth compressors, 15-55 kW / 20-75 hp ZT 15-22, ZR/ZT 30-45, ZR/ZT 22-37-55 VSD

Atlas Copco's ZR/ZT oil-free rotary tooth compressors meet your needs for pure oil-free air while offering wide pressure ranges and improved energy efficiency. Developed especially for applications demanding the highest levels of purity, such as pharmaceutical production, food processing and critical electronics, ZR/ZT compressors eliminate the risks of oil contamination as well as the resulting extra costs. These ISO 8573-1 CLASS 0 certified compressors are easy to operate and are available with Variable Speed Drive for further energy savings.

CUSTOMER BENEFITS

- Certified 100% oil-free air** – ZR/ZT compressors provide 100% pure, clean air, complying with ISO 8573-1 CLASS 0 (2010) certification. CLASS 0 means zero risk of contamination; zero risk of damaged or unsafe products; zero risk of losses from operational downtime; and zero risk of damaging your company's hard-won professional reputation. In 2006, Atlas Copco was the first manufacturer in the world to receive such certification for an oil-free compressor.
- VSD for direct energy savings** – Energy savings of 35% on average are possible with the Variable Speed Drive versions:
 - Unload losses are reduced to a minimum.
 - No blow-off of compressed air to the atmosphere.
 - Load/no load transition losses are eliminated.
 - Precise pressure control allows a tighter pressure band and a lower average working pressure, resulting in reduced energy consumption.
- Quiet operation** – The vertical layout of the coolers reduces the noise levels from the fan, motor and element. Moreover, ZR/ZT compressors are supplied in a sound-insulated canopy, thus avoiding the need for a separate compressor room and allowing installation in most working environments.
- Advanced control and monitoring** – To maximize efficiency and reliability, the Elektronikon® controls the main drive motor and regulates system pressure within a predefined and narrow pressure band. The Elektronikon® controller can be adapted to your specific needs with extra sensors, digital contacts, fieldbus, Internet and SMS communication functions. In combination with the ES multiple compressor controller, the operation of your complete compressor room is optimized.
- Easy maintenance** – The robust air inlet filter offers a long lifetime and high reliability for long service intervals and low maintenance needs.



Type	Max. working pressure		Capacity FAD*			Installed motor power		Noise level**	Weight without dryer***		Integrated dryer available
	bar(e)	psig	l/s	m ³ /min	cfm	kW	hp	dB(A)	kg	lbs	
Air-cooled only											
ZT 15	7.5	109	37.6	2.3	80	15	20	65	1060	2337	ID
	8.6	125	34.9	2.1	74						
	10	145	29.9	1.8	63						
ZT 18	7.5	109	48.0	2.9	102	18	25	67	1080	2381	ID/IMD
	8.6	125	45.7	2.7	97						
	10	145	37.2	2.2	79						
ZT 22	7.5	109	59.0	3.5	125	22	30	69	1086	2394	ID/IMD
	8.6	125	53.2	3.2	113						
	10	145	45.0	2.7	95						
Air-(ZT) and water-cooled (ZR)											
ZR/ZT 30	7.5	109	78.7	4.7	167	30	40	63	1432	3157	ID/IMD
	8.6	125	73.7	4.4	156						
ZR/ZT 37	7.5	109	96.5	5.8	204	37	50	65	1432	3157	ID/IMD
	8.6	125	92.1	5.5	195						
ZR/ZT 45	7.5	109	114.4	6.9	243	45	60	67	1432	3157	ID/IMD
	8.6	125	108.9	6.5	231						
ZT 22 VSD	7.5	109	20.6-55.3	1.3-3.4	43.8-117.6	22	30	69	1120	2469	ID
	8.6	125	20.1-51.0	1.2-3.1	42.7-108.5						
	10	145	19.7-47.0	1.2-2.8	41.9-100						
ZR/ZT 37 VSD	7.5	109	41.3-101.2	2.5-6.2	87.8-215.2	37	50	68	1432	3157	ID/IMD
	8.6	125	41.2-97.3	2.5-5.9	87.6-206.9						
ZR/ZT 55 VSD	7.5	109	41.3-142.5	2.5-8.7	87.6-303.1	55	75	68	1432	3157	ID/IMD
	8.6	125	41.2-138.8	2.5-8.4	87.6-295.2						

* Unit performance measured according to ISO 1217, Ed. 4, 2009, Annex E.

Reference conditions:

- absolute Inlet pressure, specify bar(a), (e) 1 bar (14.5 psi)
- intake air temperature 20°C (68°F)

** Noise level* measured according to Pneurop/Cagi PN8NTC2, tolerance: 3 dB(A).

*** Integrated dryers will increase the weight.

**** For ZT air-cooled units: +3 dB(A).

FAD is measured at the following working pressure:

- 7.5 bar versions at 7 bar.
- 8.6 bar versions at 8 bar.
- 10 bar versions at 9.75 bar.

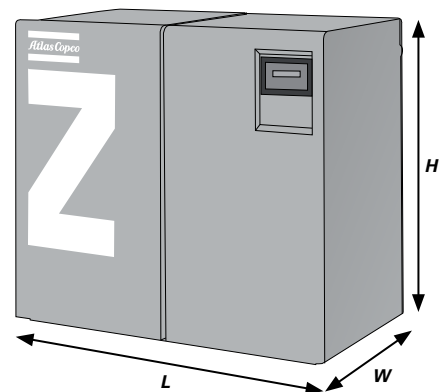

	Dimensions L x W x H		
	Length	Width	Height
ZT 15-22	1760 / 69.3"	1026 / 40.4"	1621 / 63.8"
ZR/ZT 30-45	2005 / 78.9"	1026 / 40.4"	1880 / 74.0"
ZT 22 VSD	2195 / 86.4"	1026 / 40.4"	1621 / 63.8"
ZR/ZT 37-55 VSD	2440 / 96.1"	1026 / 40.4"	1880 / 74.0"

Oil-free air- and water-cooled rotary screw compressors, 55-935 kW / 75-1253 hp

Z 55-900 (VSD)

Atlas Copco's Z 55-900 VSD Pack and Full Feature ranges power your production with ultimate reliability and efficiency under the harshest conditions. The first air compressors in the world to be certified Class 0 according to ISO 8573-1 edition 2, 2010, they ensure completely oil-free air to protect your process and end products. Several energy saving features – Variable Speed Drive, energy-free MD dryers and energy recovery – are offered. Z 55-900 VSD compressors are all-inclusive, plug-and-play packages that ensure easy and low cost installation and a quick start-up.

CUSTOMER BENEFITS

- **Highest reliability** – For over 680 years, Z compressors stand for durability and reliability. They incorporate Atlas Copco's proven screw technology, stainless steel coolers, AGMA A4/ DIN 5 gears and state-of-the art electrical drive systems, all of which contribute to overall high reliability. Z compressors are built using long-standing internal engineering practices, and are manufactured and tested according to ISO 9001.
- **Certified 100% oil-free** – Z 55-900 compressors provide you with 100% pure, clean air that complies with ISO 8573-1 CLASS 0 (2010) certification. CLASS 0 means zero risk of contamination; zero risk of damaged or unsafe products; zero risk of losses from operational downtime; and zero risk of damaging your company's hard-won professional reputation. In 2006 Atlas Copco was the first manufacturer in the world to receive such certification on an oil-free compressor.
- **Maximum energy savings** – Atlas Copco's unique and time proven rotor coating ensures high efficiency over the compressors lifetime. The state-of-the art air compressor element is powered by a high-efficiency electric motor, contributing to maximum compressor package efficiency. Further optimize your energy savings with our innovative and unique Variable Speed Drive, our energy recovery feature and energy-free MD dryers.
- **Easy installation** – The integrated design of the Z compressor includes internal piping, coolers, motor, lubrication and control system: all supplied as a ready-to-use package. Installation is fault-free, commissioning time is low and no external instrument air is required.
- **Advanced control and monitoring** – To maximize efficiency and reliability, the Elektronikon® controls the main drive motor and regulates system pressure within a predefined and narrow pressure band. The Elektronikon® controller can be adapted to your specific needs with extra sensors, digital contacts, fieldbus, Internet and SMS communication functions. In combination with the ES multiple compressor controller, the operation of your complete compressor room is optimized.



True performance:

Atlas Copco Z-compressors are measured according to ISO 1217, Edition 3, Annex C stipulating the Capacity FAD measurement at the outlet of the package, net of all losses.

Atlas Copco specifications correspond to the capacity and pressure that are effectively available to the user, not to the air volume that is sucked in. Differences can be substantial.

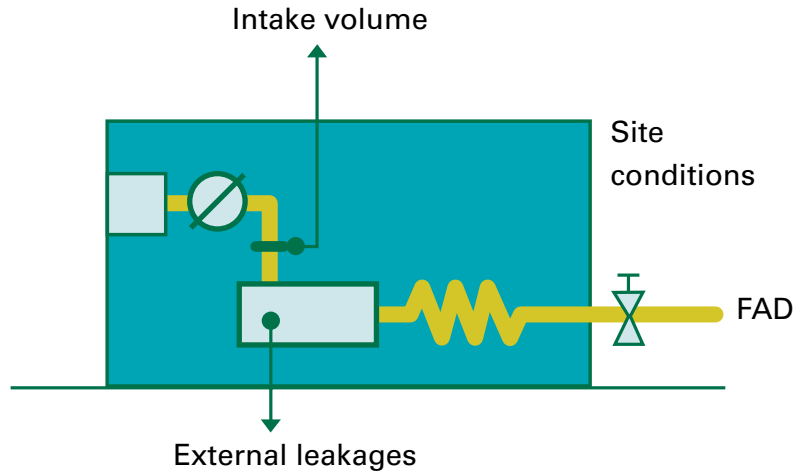

Dimensions & weight

	A	B	C	Weight		A	B	C	Weight		A	B	C	Weight
ZR 55	2180	1450	2184	1640	ZR 55 FF	2180	1450	2184	1890	ZR 55 *	2180	1450	2184	1640
ZR 75	2180	1450	2184	1715	ZR 75 FF	2180	1450	2184	1965	ZR 75 *	2180	1450	2184	1715
ZR 90	2180	1450	2184	1780	ZR 90 FF	2180	1450	2184	2030	ZR 90 *	2180	1450	2184	1780
ZR 75 VSD	2630	1450	2184	2030	ZR 75 VSD-FF	2630	1450	2184	2280	ZR 75 VSD *	2630	1450	2184	2030
ZR 90 VSD	2630	1450	2184	2030	ZR 90 VSD-FF	2630	1450	2184	2280	ZR 90 VSD *	2630	1450	2184	2030
ZT 55	2180	1450	2184	1760	ZT 55 FF	2880	1450	2184	2360	ZR 55 FF *	2880	1450	2184	1990
ZT 75	2180	1450	2184	1835	ZT 75 FF	2880	1450	2184	2475	ZR 75 FF *	2880	1450	2184	2065
ZT 90	2180	1450	2184	1900	ZT 90 FF	2880	1450	2184	2500	ZR 90 FF *	2880	1450	2184	2130
ZT 75 VSD	2630	1450	2184	2100	ZT 75 VSD-FF	3330	1450	2184	2700	ZR 75 VSD-FF *	3330	1450	2184	2370
ZT 90 VSD	2630	1450	2184	2100	ZT 90 VSD-FF	3330	1450	2184	2700	ZR 90 VSD-FF *	3330	1450	2184	2370

- ⁽¹⁾ Reference conditions:
- dry air
 - absolute Inlet pressure, specify bar(a), (e) 1 bar(a)
 - cooling and air intake temperature 20 °C
 - nominal working pressure
 - performance of the compressor package measured according to ISO 1217, Third Edition, Annex C

* Equipped with Energy Recovery system

- ⁽²⁾ Cooling water temperature rise of 15 °C
- ⁽³⁾ Max. capacity is at reference pressure and not at max. pressure
- ⁽⁴⁾ Pressure dewpoint is specified for
- 20 °C cooling air/water temperature
 - relative humidity of 60 %
 - nominal working pressure
 - load level of minimum 50 %
- For VSD: at reference speed
- ⁽⁵⁾ ± 3 dB(A) measured at a distance of 1 m and according to ISO 2151:2004 and using ISO 9614-2
- ⁽⁶⁾ Maximum intake / cooling air temperature is 50 °C for HAT versions

- Conversions
- 1 kg = 2.2 lbs
 - 1 mm = 0.039 inch
 - °F = °C x 9/5 + 32



ZR 55-90 FF

ZR/ZR FF Watercooled oil-free compressors	Capacity FAD ⁽¹⁾			Installed motor power		Cooling water consumption ⁽²⁾		Pressure dewpoint ⁽⁴⁾	Sound pressure level ⁽⁵⁾
	Type	l/s	m ³ /min	cfm	kW	hp	ZR	ZR-FF	
50 Hz units									
ZR 55 - 7.5	143	8.6	303	55	75	0.9	1.3	-24	65
ZR 55 - 8.6	131	7.9	278	55	75	0.9	1.3	-24	65
ZR 55 - 10	121	7.3	257	55	75	0.9	1.3	-25	65
60 Hz units									
ZR 55 - 7.25	155	9.3	329	55	75	1	1.4	-24	65
ZR 55 - 9	138	8.3	293	55	75	1	1.4	-25	65
ZR 55 - 10.4	128	7.7	271	55	75	1	1.4	-25	65
50 Hz units									
ZR 75 - 7.5	194	11.6	411	75	100	1.2	1.8	-26	65
ZR 75 - 8.6	184	11.0	390	75	100	1.2	1.8	-26	65
ZR 75 - 10	174	10.4	369	75	100	1.2	1.8	-27	65
60 Hz units									
ZR 75 - 7.25	213	12.8	452	75	100	1.3	1.9	-26	65
ZR 75 - 9	194	11.6	411	75	100	1.3	1.9	-27	65
ZR 75 - 10.4	185	11.1	392	75	100	1.3	1.9	-27	65
50 Hz units									
ZR 90 - 7.5	234	14.0	496	90	120	1.4	2.1	-27	65
ZR 90 - 8.6	220	13.2	466	90	120	1.4	2.1	-28	65
ZR 90 - 10	209	12.5	443	90	120	1.4	2.1	-28	65
60 Hz units									
ZR 90 - 7.25	262	15.7	555	90	120	1.6	2.3	-26	65
ZR 90 - 9	235	14.1	498	90	120	1.6	2.3	-28	65
ZR 90 - 10.4	224	13.4	475	90	120	1.6	2.3	-29	65

ZR 75-90 VSD-FF

ZR VSD / ZR VSD-FF Watercooled oil-free compressors	Capacity FAD ⁽¹⁾			Cooling water consumption ⁽²⁾		Pressure dewpoint ⁽⁴⁾	Sound pressure level ⁽⁵⁾	
	Types – 50/60 Hz	l/s	m ³ /min	cfm	ZR	ZR-FF		ZR-FF
					l/s	l/s	°C	dB(A)
ZR 75 VSD-9 bar (e)					1.25	1.92	-30	65
Max ⁽³⁾	220	13.2	466					
Min	75	4.5	159					
ZR 75 VSD-10.4 bar (e)					1.25	1.92	-30	65
Max ⁽³⁾	198	11.9	420					
Min	98	5.9	208					
ZR 90 VSD-9 bar (e)					1.25	1.92	-30	65
Max ⁽³⁾	258	15.5	547					
Min	75	4.5	159					
ZR 90 VSD-10.4 bar (e)					1.25	1.92	-30	65
Max ⁽³⁾	232	13.9	492					
Min	98	5.9	208					

⁽¹⁾ Reference conditions:

- dry air
- absolute inlet pressure 1 bar(a)
- cooling and air intake temperature 20 °C
- nominal working pressure
- performance of the compressor package measured according to ISO 1217, Third Edition, Annex C

⁽²⁾ Cooling water temperature rise of 15 °C

⁽³⁾ Max. capacity is at reference pressure and not at max. pressure

⁽⁴⁾ Pressure dewpoint is specified for

- 20 °C cooling air/water temperature

- relative humidity of 60 %

- nominal working pressure

- load level of minimum 50 %

For VSD: at reference speed

⁽⁵⁾ ± 3 dB(A) measured at a distance of 1 m and according to ISO 2151:2004 and using ISO 9614-2

⁽⁶⁾ Maximum intake / cooling air temperature is 50 °C for HAT versions

Conversions

- 1 kg = 2.2 lbs

- 1 mm = 0.039 inch

- °F = °C x 9/5 + 32

ZT 55-90 FF

ZT/ZT FF Aircooled oil-free compressors	Capacity FAD ⁽¹⁾			Installed motor power		Installed fan motor		Pressure dewpoint ⁽⁴⁾	Sound pressure level ⁽⁵⁾	
	Type	l/s	m ³ /min	cfm	kW	hp	ZT	ZT-FF		ZT-FF
							kW	kW	°C	dB(A)
50 Hz										
ZT 55 - 7.5	142	8.5	301	55	75	2	3.1	-28	72	
ZT 55 - 8.6	130	7.8	276	55	75	2	3.1	-28	72	
ZT 55 - 8.6 HAT ⁽⁶⁾	120	7.2	254	55	75	2	-	-	72	
ZT 55 - 10	120	7.2	254	55	75	2	3.1	-28	72	
60 Hz										
ZT 55 - 7.25	154	9.2	326	55	75	2	3.6	-28	72	
ZT 55 - 8.6 HAT ⁽⁶⁾	127	7.6	269	55	75	2	-	-	72	
ZT 55 - 9	137	8.2	290	55	75	2	3.6	-28	72	
ZT 55 - 10.4	127	7.6	269	55	75	2	3.6	-29	72	
50 Hz										
ZT 75 - 7.5	193	11.6	409	75	100	3.6	4.7	-30	72	
ZT 75 - 8.6	184	11.0	390	75	100	3.6	4.7	-30	72	
ZT 75 - 8.6 HAT ⁽⁶⁾	174	10.4	369	75	100	3.6	-	-	72	
ZT 75 - 10	174	10.4	369	75	100	3.6	4.7	-31	72	
60 Hz units										
ZT 75 - 7.25	212	12.7	449	75	100	3.8	5.6	-30	72	
ZT 75 - 8.6 HAT ⁽⁶⁾	184	11.1	390	75	100	3.8	-	-	72	
ZT 75 - 9	194	11.6	411	75	100	3.8	5.6	-31	72	
ZT 75 - 10.4	184	11.0	390	75	100	3.8	5.6	-31	72	
50 Hz units										
ZT 90 - 7.5	233	14.0	494	90	120	3.6	4.7	-31	72	
ZT 90 - 8.6	220	13.2	466	90	120	3.6	4.7	-32	72	
ZT 90 - 8.6 HAT ⁽⁶⁾	208	12.5	441	90	120	3.6	-	-	72	
ZT 90 - 10	208	12.5	441	90	120	3.6	4.7	-32	72	
60 Hz units										
ZT 90 - 7.25	261	15.7	553	90	120	3.8	5.6	-32	72	
ZT 90 - 8.6 HAT ⁽⁶⁾	222	13.3	470	90	120	3.8	-	-	72	
ZT 90 - 9	236	14.2	500	90	120	3.8	5.6	-32	72	
ZT 90 - 10.4	222	13.3	471	90	120	3.8	5.6	-33	72	

ZT 75-90 VSD-FF

ZT VSD / ZT VSD-FF Aircooled oil-free compressors	Capacity FAD ⁽¹⁾			Pressure dewpoint ⁽⁴⁾	Sound pressure level ⁽⁵⁾	
	Types – 50/60 Hz	l/s	m ³ /min	cfm	ZT-FF	°C
ZT 75 VSD-9 bar (e)						
Max ⁽³⁾	220	13.2	466		-30	72
Min	75	4.5	159			
ZT 75 VSD-10.4 bar (e)						
Max ⁽³⁾	198	11.9	420		-30	72
Min	98	5.9	208			
ZT 90 VSD-9 bar (e)						
Max ⁽³⁾	258	15.5	547		-30	72
Min	75	4.5	159			
ZT 90 VSD-10.4 bar (e)						
Max ⁽³⁾	232	13.9	492		-30	72
Min	98	5.9	208			

⁽¹⁾ Reference conditions:

- dry air
- absolute inlet pressure 1 bar(a)
- cooling and air intake temperature 20 °C
- nominal working pressure
- performance of the compressor package measured according to ISO 1217, Third Edition, Annex C

⁽²⁾ Cooling water temperature rise of 15 °C

⁽³⁾ Max. capacity is at reference pressure and not at max. pressure

⁽⁴⁾ Pressure dewpoint is specified for

- 20 °C cooling air/water temperature
- relative humidity of 60 %
- nominal working pressure
- load level of minimum 50 %

For VSD: at reference speed

⁽⁵⁾ ± 3 dB(A) measured at a distance of 1 m and according to ISO 2151:2004 and using ISO 9614-2

⁽⁶⁾ Maximum intake / cooling air temperature is 50 °C for

- HAT versions
- Conversions
- 1 kg = 2.2 lbs
 - 1 mm = 0.039 inch
 - °F = °C x 9/5 + 32

ZR 110-750 and ZR 132-900 VSD compressors - 50 Hz

	ZR watercooled	Capacity FAD ⁽¹⁾			Installed motor power	Cooling water consumption ⁽²⁾	Pressure dewpoint ⁽³⁾	Noise level ⁽⁴⁾		Weight	Dimensions L x W x H		
	Type	l/s	m ³ /min	cfm				kW	l/s		°C	w/o duct dB(A)	with duct dB(A)
50 Hz - 7.5 bar(e)													
FF (with IMD Dryer)	ZR 110	318	19.1	674	110	3.5	-28	70	68	3265	3440	2000	1650
	ZR 132	367	22.0	778	132	4.1	-29	70	68	3390	3440	2000	1650
	ZR 145	394	23.6	835	145	4.2	-30	70	68	3530	3440	2000	1650
	ZR 160	471	28.3	998	160	4.4	-25	67	66	4705	4340	2000	1650
	ZR 200	607	36.4	1286	200	5.1	-25	67	66	5365	4340	2000	1650
	ZR 250	726	43.6	1538	250	5.8	-28	67	66	5360	4340	2000	1650
	ZR 275	780	46.8	1653	275	6.2	-30	67	66	5560	4340	2000	1650
Pack (w/o IMD Dryer)	ZR 110	318	19.1	674	110	1.7	-	67	65	2635	2540	2000	1650
	ZR 132	367	22.0	778	132	1.9	-	67	65	2760	2540	2000	1650
	ZR 145	394	23.6	835	145	2.0	-	67	66	2900	2540	2000	1650
	ZR 160	471	28.3	998	160	2.3	-	67	66	3795	3140	2000	1650
	ZR 200	607	36.4	1286	200	3.0	-	67	66	3995	3140	2000	1650
	ZR 250	726	43.6	1538	250	3.7	-	67	66	3990	3140	2000	1650
	ZR 275	780	46.8	1653	275	4.1	-	67	66	4190	3140	2000	1650
	ZR 300	775	46.5	1642	315	4.0	-	70	69	6650	3700	2400	2120
	ZR 315	855	51.3	1812	315	4.4	-	71	69	6650	3700	2400	2120
	ZR 355	949	56.9	2011	355	4.8	-	71	69	6950	3700	2400	2120
	ZR 400	1049	62.9	2223	400	5.4	-	71	70	7050	3700	2400	2120
	ZR 425	1162	69.7	2462	450	6.2	-	72	70	7250	3700	2400	2120
	ZR 450	1257	75.4	2663	450	7.2	-	73	71	9500	4060	2400	2120
	ZR 500	1387	83.2	2939	500	7.8	-	73	71	9500	4060	2400	2120
	ZR 630	1726	103.6	3657	630	9.4	-	75	73	10225	4060	2400	2120
ZR 750	2075	124.5	4397	750	11.3	-	75	73	10325	4060	2400	2120	

⁽¹⁾ Reference conditions:

- dry air
- absolute inlet pressure 1 bar(a)
- cooling and air intake temperature 20 °C
- nominal working pressure
- performance of the compressor package measured according to ISO 1217, Third Edition, Annex C

⁽²⁾ Cooling water temperature rise of 15 °C

⁽³⁾ Max. capacity is at reference pressure and not at max. pressure

- ⁽⁴⁾ Pressure dewpoint is specified for
- 20 °C cooling air/water temperature
 - relative humidity of 60 %
 - nominal working pressure
 - load level of minimum 50 %
- For VSD: at reference speed

⁽⁵⁾ ± 3 dB(A) measured at a distance of 1 m and

according to ISO 2151:2004 and using ISO 9614-2

⁽⁶⁾ Maximum intake / cooling air temperature is 50 °C for HAT versions

Conversions

- 1 kg = 2.2 lbs
- 1 mm = 0.039 inch
- °F = °C x 9/5 + 32

ZR 110-750 and ZR 132-900 VSD compressors - 50 Hz

	ZR water-cooled	Capacity FAD ⁽¹⁾			Installed motor power	Cooling water consumption ⁽²⁾	Pressure dewpoint ⁽³⁾	Noise level ^{*(4)}		Weight	Dimensions L x W x H		
		Type	l/s	m ³ /min				cfm	kW		l/s	°C	w/o duct dB(A)
50 Hz - 8.6 bar(e)													
FF (with IMD Dryer)	ZR 110	285	17.1	604	110	3.1	-28	70	68	3265	3440	2000	1650
	ZR 132	326	19.6	691	132	3.5	-29	70	68	3390	3440	2000	1650
	ZR 132 VSD	372	22.3	778	132	3.9	-28/-32	68-72	66-69	3500	3440	2000	1650
	ZR 145	362	21.7	767	145	3.9	-30	70	68	3530	3440	2000	1650
	ZR 160	435	26.1	922	160	4.2	-25	67	66	4705	4340	2000	1650
	ZR 160 VSD	431	25.9	913	160	4.2	-28/-32	68-74	66-71	3500	3440	2000	1650
	ZR 200	553	33.2	1172	200	4.8	-25	67	66	5365	4340	2000	1650
	ZR 250	691	41.5	1464	250	5.6	-28	67	66	5360	4340	2000	1650
	ZR 250 VSD	721	43.3	1528	250	5.8	-25/-30	63-73	62-71	6080	4340	2000	1650
	ZR 275	723	43.4	1532	275	5.8	-30	67	66	5560	4340	2000	1650
ZR 315 VSD	836	50.2	1771	299	6.8	-25/-30	63-73	62-71	6080	4340	2000	1650	
Pack (w/o IMD Dryer)	ZR 110	285	17.1	604	110	1.5	-	67	65	2635	2540	2000	1650
	ZR 132	326	19.6	691	132	1.7	-	67	65	2760	2540	2000	1650
	ZR 132 VSD	376	22.6	797	132	1.9	-	62-68	61-66	2870	2540	2000	1650
	ZR 145	362	21.7	767	145	1.9	-	67	66	2900	2540	2000	1650
	ZR 160	435	26.1	922	160	2.2	-	67	66	3795	3140	2000	1650
	ZR 160 VSD	436	26.1	922	160	2.2	-	62-70	61-66	2870	2540	2000	1650
	ZR 200	553	33.2	1172	200	2.8	-	67	66	3995	3140	2000	1650
	ZR 250	691	41.5	1464	250	3.5	-	67	66	3990	3140	2000	1650
	ZR 250 VSD	721	43.3	1528	250	3.7	-	63-73	62-71	4710	3140	2000	1650
	ZR 275	723	43.4	1532	275	3.8	-	67	66	4190	3140	2000	1650
	ZR 300	723	43.4	1532	315	4.1	-	71	70	6650	3700	2400	2120
	ZR 315	798	47.9	1691	315	4.5	-	72	70	6650	3700	2400	2120
	ZR 315 VSD	836	50.2	1771	299	4.3	-	63-73	62-71	4710	3140	2000	1650
	ZR 355	886	53.2	1877	355	4.9	-	72	72	6950	3700	2400	2120
	ZR 400	978	58.7	2072	400	5.4	-	72	71	7050	3700	2400	2120
	ZR 400 VSD	1114	66.9	2361	425	6.4	-	68-75	66-73	8350	4060	2470	2120
	ZR 425	1081	64.9	2291	450	6.2	-	73	71	7250	3700	2400	2120
	ZR 450	1166	70.0	2471	450	7.1	-	74	72	9500	4060	2400	2120
	ZR 500	1291	77.5	2735	500	7.7	-	74	72	9500	4060	2400	2120
	ZR 500 VSD	1318	79.1	2793	525	7.6	-	68-76	66-74	8350	4060	2470	2120
ZR 630	1602	96.1	3394	630	9.3	-	76	74	10225	4060	2400	2120	
ZR 700 VSD	2063	123.8	4371	700	11.6	-	70-78	68-76	11850	4675	2470	2120	
ZR 750	1850	111.0	3920	750	10.7	-	76	74	10325	4060	2400	2120	
ZR 900 VSD	2456	147.4	5204	935	13.2	-	68-78	68-76	11850	4675	2470	2120	
50 Hz - 10 bar(e)													
FF (with IMD Dryer)	ZR 110	265	15.9	562	110	3.3	-28	70	68	3265	3440	2000	1650
	ZR 132	313	18.8	663	132	3.8	-29	70	68	3390	3440	2000	1650
	ZR 132 VSD	330	19.8	699	132	4.1	0,875	68-72	66-69	3500	3440	2000	1650
	ZR 145	334	20.0	708	145	4.1	-30	70	68	3530	3440	2000	1650
	ZR 160	402	24.1	852	160	4.3	-25	67	66	4705	4340	2000	1650
	ZR 160 VSD	392	23.5	831	160	4.4	0,875	68-74	66-71	3500	3440	2000	1650
	ZR 200	504	30.2	1068	200	4.9	-25	67	66	4905	4340	2000	1650
	ZR 250	629	37.7	1333	250	5.6	-28	67	66	5360	4340	2000	1650
	ZR 250 VSD	648	38.9	1373	250	5.8	-25/-30	67-73	65-71	6080	4340	2000	1650
	ZR 275	689	41.3	1460	275	6.0	-30	67	66	5560	4340	2000	1650
ZR 315 VSD	746	44.8	1581	299	6.7	-25/-30	67-73	65-71	6080	4340	2000	1650	
Pack (w/o IMD Dryer)	ZR 110	265	15.9	562	110	1.6	-	67	65	2380	2540	2000	1650
	ZR 132	313	18.8	663	132	1.8	-	67	65	2440	2540	2000	1650
	ZR 132 VSD	333	20.0	706	132	1.9	-	62-68	61-66	2590	2540	2000	1650
	ZR 145	334	20.0	708	145	1.9	-	67	66	2580	2540	2000	1650
	ZR 160	402	24.1	852	160	2.3	-	67	66	3795	3140	2000	1650
	ZR 160 VSD	394	23.6	835	160	2.1	-	62-70	61-66	2590	2540	2000	1650
	ZR 200	504	30.2	1068	200	2.9	-	67	66	3995	3140	2000	1650
	ZR 250	629	37.7	1333	250	3.6	-	67	66	3990	3140	2000	1650
	ZR 250 VSD	648	38.9	1373	250	3.7	-	64-70	65-68	4710	3140	2000	1650
	ZR 275	689	41.3	1460	275	4.0	-	67	66	4190	3140	2000	1650
	ZR 300	689	41.3	1460	315	4.2	-	71	70	6650	3700	2400	2120
	ZR 315	765	45.9	1621	315	4.5	-	72	70	6650	3700	2400	2120
	ZR 315 VSD	746	44.8	1581	299	4.3	-	63-73	62-71	4710	3140	2000	1650
	ZR 355	846	50.8	1793	355	4.9	-	73	71	6950	3700	2400	2120
	ZR 400	939	56.3	1990	400	5.4	-	73	71	7050	3700	2400	2120
	ZR 400 VSD	979	58.7	2074	425	5.7	-	69-76	66-73	8350	4060	2470	2120
	ZR 450	1047	62.8	2218	450	7.1	-	74	72	9500	4060	2400	2120
	ZR 500	1199	71.9	2541	500	7.9	-	74	72	9500	4060	2400	2120
	ZR 500 VSD	1150	69.0	2437	525	7.6	-	69-77	66-74	8350	4060	2470	2120
	ZR 630	1474	88.4	3123	630	9.3	-	76	74	10225	4060	2400	2120
ZR 700 VSD	1859	111.5	3939	700	11.4	-	70-78	68-76	11850	4675	2470	2120	
ZR 750	1704	102.2	3611	750	10.5	-	76	74	10325	4060	2400	2120	
ZR 900 VSD	2057	123.4	4359	935	12.5	-	68-79	68-77	11850	4675	2470	2120	
50 Hz - 13 bar(e)													
FF (with IMD)	ZR 145	297	17.8	629	145	4.2	-30	75	72	3530	3440	2000	1650
	ZR 250	505	30.3	1070	250	5.4	-28	72	70	5360	4340	2000	1650
	ZR 275	550	33.0	1165	275	5.7	-30	72	70	5560	4340	2000	1650
Pack (w/o IMD)	ZR 145	297	17.8	629	145	2.0	-	75	72	2900	2540	2000	1650
	ZR 250	505	30.3	1070	250	3.4	-	72	70	3990	3140	2000	1650
	ZR 275	551	33.1	1168	275	3.7	-	72	70	4190	3140	2000	1650

ZR 110-750 and ZR 132-900 VSD compressors - 60 Hz

	ZR watercooled	Capacity FAD ⁽¹⁾			Installed motor power	Cooling water consumption ⁽²⁾	Pressure dewpoint ⁽³⁾	Noise level* ⁽⁴⁾		Weight	Dimensions L x W x H		
		Type	l/s	m ³ /min				cfm	HP		l/s	°C	w/o duct dB(A)
60 Hz - 7 bar(e)													
FF (with IMD Dryer)	ZR 110	352	21.1	746	150	3.9	-28	70	68	3265	3440	2000	1650
	ZR 160	463	27.8	981	200	4.4	-25	67	66	4695	4340	2000	1650
	ZR 200	574	34.4	1216	250	4.9	-25	67	66	5305	4340	2000	1650
	ZR 250	667	40.0	1413	300	5.4	-28	67	66	5515	4340	2000	1650
	ZR 275	752	45.1	1593	350	5.9	-30	67	66	5635	4340	2000	1650
Pack (w/o IMD Dryer)	ZR 110	352	21.1	746	150	1.9	-	67	65	2635	2540	2000	1650
	ZR 160	463	27.8	981	200	2.3	-	67	66	3785	3140	2000	1650
	ZR 200	574	34.4	1216	250	2.9	-	67	66	3935	3140	2000	1650
	ZR 250	667	40.0	1413	300	3.4	-	67	66	4145	3140	2000	1650
ZR 275	752	45.1	1593	350	3.8	-	67	66	4265	3140	2000	1650	
60 Hz - 8.6 bar(e)													
FF (with IMD Dryer)	ZR 110	321	19.3	679	150	3.8	-28	70	68	3265	3440	2000	1650
	ZR 132 VSD	372	22.3	778	175	3.9	-28/-32	68-72	66-69	3500	3440	2000	1650
	ZR 145	398	23.9	843	200	4.1	-30	70	68	3530	3440	2000	1650
	ZR 160	419	25.1	888	200	4.4	-25	67	66	4695	4340	2000	1650
	ZR 160 VSD	431	25.9	913	215	4.2	-28/-32	68-74	66-71	3500	3440	2000	1650
	ZR 200	516	31.0	1093	250	4.6	-25	67	66	5305	4340	2000	1650
	ZR 250	619	37.1	1312	300	5.2	-28	67	66	5515	4340	2000	1650
	ZR 250 VSD	721	43.3	1528	335	5.8	-25/-30	63-73	62-71	6080	4340	2000	1650
	ZR 275	726	43.6	1538	350	5.8	-30	67	66	5635	4340	2000	1650
	ZR 315 VSD	836	50.2	1771	400	6.8	-25/-30	63-73	62-71	6080	4340	2000	1650
	ZR 110	321	19.3	679	150	1.7	-	67	65	2635	2540	2000	1650
Pack (w/o IMD Dryer)	ZR 132 VSD	376	22.6	797	175	1.9	-	62-68	61-66	2870	2540	2000	1650
	ZR 145	398	23.9	843	200	2.1	-	68	66	2900	2540	2000	1650
	ZR 160	419	25.1	888	200	2.1	-	67	66	3785	3140	2000	1650
	ZR 160 VSD	436	26.1	922	215	2.2	-	62-70	61-66	2870	2540	2000	1650
	ZR 200	516	31.0	1093	250	2.6	-	67	66	3935	3140	2000	1650
	ZR 250	619	37.1	1312	300	3.1	-	67	66	4145	3140	2000	1650
	ZR 250 VSD	721	43.3	1528	335	3.7	-	63-73	62-71	4710	3140	2000	1650
	ZR 275	726	43.6	1538	350	3.7	-	67	66	4265	3140	2000	1650
	ZR 300	755	45.3	1600	350	4.1	-	71	70	6550	3700	2400	2120
	ZR 315	850	51.0	1801	400	4.6	-	72	70	6550	3700	2400	2120
	ZR 315 VSD	836	50.2	1771	400	4.3	-	63-73	62-71	4710	3140	2000	1650
	ZR 355	955	57.3	2024	450	5.1	-	72	70	6950	3700	2400	2120
	ZR 400	1043	62.6	2210	500	5.6	-	72	71	7050	3700	2400	2120
	ZR 400 VSD	1114	66.9	2361	570	6.4	-	68-75	66-73	8320	4060	2470	2120
	ZR 450	1306	78.4	2767	600	7.8	-	74	72	9300	4060	2400	2120
	ZR 500	1538	92.3	3259	700	8.9	-	74	72	9500	4060	2400	2120
	ZR 500 VSD	1318	79.1	2793	703	7.6	-	68-76	66-74	8320	4060	2470	2120
	ZR 630	1700	102.0	3602	800	9.9	-	76	74	10225	4060	2400	2120
	ZR 700 VSD	2063	123.8	4371	938	11.6	-	70-78	68-76	11850	4675	2470	2120
	ZR 750	1939	116.3	4109	900	11.2	-	76	74	10225	4060	2400	2120
ZR 900 VSD	2456	147.4	5204	1253	13.2	-	68-78	68-76	11850	4675	2470	2120	

⁽¹⁾ Reference conditions:

- dry air
- absolute inlet pressure 1 bar(a)
- cooling and air intake temperature 20 °C
- nominal working pressure
- performance of the compressor package measured according to ISO 1217, Third Edition, Annex C

⁽²⁾ Cooling water temperature rise of 15 °C⁽³⁾ Max. capacity is at reference pressure and not at max. pressure

- ⁽⁴⁾ Pressure dewpoint is specified for
 - 20 °C cooling air/water temperature
 - relative humidity of 60 %
 - nominal working pressure
 - load level of minimum 50 %

⁽⁵⁾ ± 3 dB(A) measured at a distance of 1 m and

according to ISO 2151:2004 and using ISO 9614-2

⁽⁶⁾ Maximum intake / cooling air temperature is 50 °C for

HAT versions

Conversions

- 1 kg = 2.2 lbs
- 1 mm = 0.039 inch
- °F = °C x 9/5 + 32

ZR 110-750 and ZR 132-900 VSD compressors - 60 Hz

	ZR water-cooled	Capacity FAD ⁽¹⁾			Installed motor power	Cooling water consumption ⁽²⁾	Pressure dewpoint ⁽³⁾	Noise level ⁽⁴⁾		Weight	Dimensions L x W x H		
		Type	l/s	m ³ /min				cfm	HP		l/s	°C	w/o duct dB(A)
60 Hz - 10.4 bar(e)													
FF (with IMD Dryer)	ZR 110	287	17.2	608	150	3.5	-28	70	68	3265	3440	2000	1650
	ZR 132 VSD	330	19.8	699	175	3.9	-28/-32	68-72	66-69	3500	3440	2000	1650
	ZR 145	336	20.2	712	200	4.1	-30	70	68	3530	3440	2000	1650
	ZR 160	375	22.5	795	200	4.4	-25	67	66	4695	4340	2000	1650
	ZR 160 VSD	392	23.5	831	215	4.2	-28/-32	68-74	66-71	3500	3440	2000	1650
	ZR 200	459	27.5	973	250	4.7	-25	67	66	4845	4340	2000	1650
	ZR 250	548	32.9	1161	300	5.2	-28	67	66	5515	4340	2000	1650
	ZR 250 VSD	648	38.9	1373	335	5.8	-25/-30	67-73	65-71	6080	4340	2000	1650
	ZR 275	641	38.5	1358	350	5.7	-30	67	66	5635	4340	2000	1650
Pack (w/o IMD Dryer)	ZR 315 VSD	746	44.8	1581	400	6.7	-25/-30	67-73	65-71	6080	4340	2000	1650
	ZR 110	287	17.2	608	150	1.7	-	67	65	2635	2540	2000	1650
	ZR 132 VSD	333	20.0	706	214	1.9	-	62-68	61-66	2590	2540	2000	1650
	ZR 145	336	20.2	712	200	2.0	-	67	66	2900	2540	2000	1650
	ZR 160	375	22.5	795	200	2.2	-	67	66	3785	3140	2000	1650
	ZR 160 VSD	394	23.6	835	215	2.1	-	62-70	61-66	2590	2540	2000	1650
	ZR 200	459	27.5	973	250	2.6	-	67	66	3935	3140	2000	1650
	ZR 250	548	32.9	1161	300	3.1	-	67	66	4145	3140	2000	1650
	ZR 250 VSD	648	38.9	1373	335	3.7	-	64-70	65-68	4710	3140	2000	1650
	ZR 275	641	38.5	1358	350	3.6	-	67	66	4265	3140	2000	1650
	ZR 300	677	40.6	1434	350	4.3	-	71	70	6550	3700	2400	2120
	ZR 315	762	45.7	1615	400	4.6	-	72	70	6550	3700	2400	2120
	ZR 315 VSD	746	44.8	1581	400	4.3	-	63-73	62-71	4710	3140	2000	1650
	ZR 355	858	51.5	1818	450	5.1	-	73	71	6950	3700	2400	2120
	ZR 400	945	56.7	2002	500	5.5	-	73	71	7050	3700	2400	2120
	ZR 400 VSD	979	58.7	2074	570	5.7	-	69-76	66-73	8350	4060	2470	2120
	ZR 450	1144	68.6	2424	600	7.7	-	74	xx	9300	4060	2400	2120
	ZR 500	1332	79.9	2822	700	8.7	-	75	xx	9500	4060	2400	2120
	ZR 500 VSD	1150	69.0	2437	703	7.6	-	69-77	66-74	8350	4060	2470	2120
	ZR 630	1474	88.4	3123	800	9.4	-	76	74	10225	4060	2400	2120
ZR 700 VSD	1859	111.5	3939	938	11.4	-	70-78	68-76	11850	4675	2470	2120	
ZR 750	1739	104.3	3685	900	10.8	-	76	74	10225	4060	2400	2120	
ZR 900 VSD	2057	123.4	4359	1253	12.5	-	68-79	68-77	11850	4675	2470	2120	
60 Hz - 13 bar(e)													
FF (with IMD Dryer)	ZR 145	299	17.9	634	200	4.3	-28	75	72	3530	3440	2000	1650
	ZR 250	491	29.5	1040	300	5.4	-28	72	70	5515	4340	2000	1650
	ZR 275	550	33.0	1165	350	5.8	-30	72	70	5635	4340	2000	1650
Pack (w/o IMD Dryer)	ZR 145	299	17.9	634	200	2.0	-	75	72	2900	2540	2000	1650
	ZR 250	491	29.5	1040	300	3.4	-	72	70	4145	3140	2000	1650
	ZR 275	550	33.0	1165	350	3.8	-	72	70	4265	3140	2000	1650

⁽¹⁾ Reference conditions:

- dry air
- absolute inlet pressure 1 bar(a)
- cooling and air intake temperature 20 °C
- nominal working pressure
- performance of the compressor package measured according to ISO 1217, Third Edition, Annex C

⁽²⁾ Cooling water temperature rise of 15 °C

⁽³⁾ Max. capacity is at reference pressure and

not at max. pressure

- ⁽⁴⁾ Pressure dewpoint is specified for
 - 20 °C cooling air/water temperature
 - relative humidity of 60 %
 - nominal working pressure
 - load level of minimum 50 %
- For VSD: at reference speed

⁽⁵⁾ ± 3 dB(A) measured at a distance of 1 m and according to ISO 2151:2004 and using ISO 9614-2

⁽⁶⁾ Maximum intake / cooling air temperature is 50 °C for

HAT versions

Conversions

- 1 kg = 2.2 lbs
- 1 mm = 0.039 inch
- °F = °C x 9/5 + 32

ZT 110-275 and ZT 132-315 VSD compressors - 50 Hz

	ZT aircooled	Capacity FAD ⁽¹⁾			Installed motor power	In- stalled fan motor	Pressure dewpoint ⁽³⁾	Noise level ⁽⁴⁾		Weight	Dimensions L x W x H			
		Type	l/s	m ³ /min				cfm	kW		kW	°C	w/o duct	with duct
								dB(A)	dB(A)		mm	mm	mm	
50 Hz - 7.5 bar(e)														
FF (with IMD Dryer)	ZT 110	312	18.7	661	110	4.8	-28	72	70	4095	4040	2000	1650	
	ZT 132	360	21.6	763	132	4.8	-29	73	70	4220	4040	2000	1650	
	ZT 145	390	23.4	826	145	4.8	-30	73	71	4360	4040	2000	1650	
	ZT 160	460	27.57	973	160	8.8	-30	77	75	5625	5040	2100	1650	
	ZT 200	563	33.75	1191	200	8.8	-25	77	75	6285	5040	2100	1650	
	ZT 250	705	42.31	1493	250	8.8	-28	77	75	6280	5040	2100	1650	
Pack (w/o IMD Dryer)	ZT 275	740	44.38	1566	315	18.5	-30	77	75	6630	5040	2100	1650	
	ZT 110	314	18.8	665	110	4.8	-	71	70	3585	4040	2000	1650	
	ZT 132	362	21.7	767	132	4.8	-	72	70	3710	4040	2000	1650	
	ZT 145	392	23.5	829	145	4.8	-	72	70	3850	4040	2000	1650	
	ZT 160	460	27.6	973	160	8.8	-	77	75	5185	5040	2100	1650	
	ZT 200	563	33.8	1191	200	8.8	-	77	75	5385	5040	2100	1650	
FF (with IMD Dryer)	ZT 250	705	42.3	1493	250	8.8	-	77	75	5380	5040	2100	1650	
	ZT 275	740	44.4	1566	275	8.8	-	77	75	5580	5040	2100	1650	
	50 Hz - 8.6 bar(e)													
	FF (with IMD Dryer)	ZT 110	281	16.9	595	110	4.8	-28	72	70	4095	4040	2000	1650
		ZT 132	322	19.3	682	132	4.8	-29	73	70	4220	4040	2000	1650
		ZT 132 VSD	349	20.9	739	132	4.8	-25/-30	67-71	66-70	4330	4040	2000	1650
ZT 145		361	21.6	785	145	4.8	-30	73	71	4360	4040	2000	1650	
ZT 160		422	25.3	894	160	8.8	-30	77	75	5625	5040	2100	1650	
ZT 160 VSD		404	24.2	856	160	4.8	-25/-30	67-74	66-71	4330	4040	2000	1650	
ZT 200		510	30.6	1081	200	8.8	-25	77	75	6285	5040	2100	1650	
ZT 250		661	39.7	1401	250	8.8	-28	77	75	6280	5040	2100	1650	
ZT 250 VSD		699	41.9	1480	250	18.5	-25/-30	70-77	68-75	6660	5040	2100	1650	
ZT 275		696	41.8	1475	275	18.5	-30	77	75	6630	5040	2100	1650	
Pack (w/o IMD Dryer)	ZT 315 VSD	789	47.4	1672	299	18.5	-25/-30	70-78	68-76	6660	5040	2100	1650	
	ZT 110	281	16.9	595	110	4.8	-	71	70	3585	4040	2000	1650	
	ZT 132	322	19.3	682	132	4.8	-	72	70	3710	4040	2000	1650	
	ZT 132 VSD	354	21.2	750	132	4.8	-	67-74	66-71	3820	4040	2000	1650	
	ZT 145	361	21.6	785	145	4.8	-	72	70	3850	4040	2000	1650	
	ZT 160	422	25.3	894	160	8.8	-	77	75	5185	5040	2100	1650	
	ZT 160 VSD	410	24.6	869	160	4.8	-	67-74	66-71	3820	4040	2000	1650	
	ZT 200	510	30.6	1081	200	8.8	-	77	75	5385	5040	2100	1650	
	ZT 250	661	39.7	1401	250	8.8	-	77	75	5380	5040	2100	1650	
	ZT 250 VSD	699	41.9	1480	250	8.8	-	70-77	68-75	6130	5040	2100	1650	
FF (with IMD Dryer)	ZT 275	696	41.8	1475	275	8.8	-	77	75	5580	5040	2100	1650	
	ZT 315 VSD	789	47.4	1672	299	8.8	-	70-78	68-76	6130	5040	2100	1650	
	50 Hz - 10 bar(e)													
	FF (with IMD Dryer)	ZT 110	260	15.6	551	110	4.8	-28	72	70	4095	4040	2000	1650
		ZT 132	313	18.8	662	132	4.8	-29	73	70	4220	4040	2000	1650
		ZT 132 VSD	316	19.0	670	132	4.8	-25/-30	67-71	66-70	4330	4040	2000	1650
		ZT 145	334	20.0	707	145	4.8	-30	73	70	4360	4040	2000	1650
		ZT 160	389	23.3	823	160	8.8	-30	78	76	5625	5040	2100	1650
		ZT 160 VSD	370	22.2	784	160	4.8	-25/-30	67-74	66-71	4330	4040	2000	1650
		ZT 200	490	29.4	1038	200	8.8	-30	78	76	5825	5040	2100	1650
ZT 250		608	36.5	1287	250	8.8	-28	78	76	6280	5040	2100	1650	
ZT 250 VSD		622	37.3	1316	250	18.5	-25/-30	71-78	69-76	6660	5040	2100	1650	
ZT 275		671	40.2	1420	275	18.5	-30	78	76	6630	5040	2100	1650	
Pack (w/o IMD Dryer)	ZT 315 VSD	709	42.5	1501	299	18.5	-25/-30	71-79	69-77	6660	5040	2100	1650	
	ZT 110	261	15.7	553	110	4.8	-	71	70	3560	4040	2000	1650	
	ZT 132	314	18.8	665	132	4.8	-	72	70	3700	4040	2000	1650	
	ZT 132 VSD	320	19.2	678	132	4.8	-	67-71	66-70	4050	4040	2000	1650	
	ZT 145	336	20.1	711	145	4.8	-	72	70	3850	4040	2000	1650	
	ZT 160	389	23.3	823	160	8.8	-	78	76	5185	5040	2100	1650	
	ZT 160 VSD	384	23.0	814	160	4.8	-	67-74	66-71	4050	4040	2000	1650	
	ZT 200	490	29.4	1038	200	8.8	-	78	76	5385	5040	2100	1650	
	ZT 250	608	36.5	1287	250	8.8	-	78	76	5380	5040	2100	1650	
	ZT 250 VSD	622	37.3	1316	250	8.8	-	71-78	69-76	6130	5040	2100	1650	
ZT 275	671	40.2	1420	275	8.8	-	78	76	5580	5040	2100	1650		
ZT 315 VSD	709	42.5	1501	299	8.8	-	71-79	69-77	6130	5040	2100	1650		

ZT 110-275 and ZT 132-315 VSD compressors - 50 Hz

	ZR water-cooled	Capacity FAD ⁽¹⁾			Installed motor power	Cooling water consumption ⁽²⁾	Pressure dewpoint ⁽³⁾	Noise level ^{*(4)}		Weight	Dimensions L x W x H		
		Type	l/s	m ³ /min				cfm	HP		l/s	°C	w/o duct dB(A)
60 Hz - 10.4 bar(e)													
FF (with IMD Dryer)	ZR 110	287	17.2	608	150	3.5	-28	70	68	3265	3440	2000	1650
	ZR 132 VSD	330	19.8	699	175	3.9	-28/-32	68-72	66-69	3500	3440	2000	1650
	ZR 145	336	20.2	712	200	4.1	-30	70	68	3530	3440	2000	1650
	ZR 160	375	22.5	795	200	4.4	-25	67	66	4695	4340	2000	1650
	ZR 160 VSD	392	23.5	831	215	4.2	-28/-32	68-74	66-71	3500	3440	2000	1650
	ZR 200	459	27.5	973	250	4.7	-25	67	66	4845	4340	2000	1650
	ZR 250	548	32.9	1161	300	5.2	-28	67	66	5515	4340	2000	1650
	ZR 250 VSD	648	38.9	1373	335	5.8	-25/-30	67-73	65-71	6080	4340	2000	1650
	ZR 275	641	38.5	1358	350	5.7	-30	67	66	5635	4340	2000	1650
ZR 315 VSD	746	44.8	1581	400	6.7	-25/-30	67-73	65-71	6080	4340	2000	1650	
Pack (w/o IMD Dryer)	ZR 110	287	17.2	608	150	1.7	-	67	65	2635	2540	2000	1650
	ZR 132 VSD	333	20.0	706	214	1.9	-	62-68	61-66	2590	2540	2000	1650
	ZR 145	336	20.2	712	200	2.0	-	67	66	2900	2540	2000	1650
	ZR 160	375	22.5	795	200	2.2	-	67	66	3785	3140	2000	1650
	ZR 160 VSD	394	23.6	835	215	2.1	-	62-70	61-66	2590	2540	2000	1650
	ZR 200	459	27.5	973	250	2.6	-	67	66	3935	3140	2000	1650
	ZR 250	548	32.9	1161	300	3.1	-	67	66	4145	3140	2000	1650
	ZR 250 VSD	648	38.9	1373	335	3.7	-	64-70	65-68	4710	3140	2000	1650
	ZR 275	641	38.5	1358	350	3.6	-	67	66	4265	3140	2000	1650
	ZR 300	677	40.6	1434	350	4.3	-	71	70	6550	3700	2400	2120
	ZR 315	762	45.7	1615	400	4.6	-	72	70	6550	3700	2400	2120
	ZR 315 VSD	746	44.8	1581	400	4.3	-	63-73	62-71	4710	3140	2000	1650
	ZR 355	858	51.5	1818	450	5.1	-	73	71	6950	3700	2400	2120
	ZR 400	945	56.7	2002	500	5.5	-	73	71	7050	3700	2400	2120
	ZR 400 VSD	979	58.7	2074	570	5.7	-	69-76	66-73	8350	4060	2470	2120
	ZR 450	1144	68.6	2424	600	7.7	-	74	xx	9300	4060	2400	2120
	ZR 500	1332	79.9	2822	700	8.7	-	75	xx	9500	4060	2400	2120
	ZR 500 VSD	1150	69.0	2437	703	7.6	-	69-77	66-74	8350	4060	2470	2120
	ZR 630	1474	88.4	3123	800	9.4	-	76	74	10225	4060	2400	2120
	ZR 700 VSD	1859	111.5	3939	938	11.4	-	70-78	68-76	11850	4675	2470	2120
ZR 750	1739	104.3	3685	900	10.8	-	76	74	10225	4060	2400	2120	
ZR 900 VSD	2057	123.4	4359	1253	12.5	-	68-79	68-77	11850	4675	2470	2120	
60 Hz - 13 bar(e)													
FF (with IMD Dryer)	ZR 145	299	17.9	634	200	4.3	-28	75	72	3530	3440	2000	1650
	ZR 250	491	29.5	1040	300	5.4	-28	72	70	5515	4340	2000	1650
	ZR 275	550	33.0	1165	350	5.8	-30	72	70	5635	4340	2000	1650
Pack (w/o IMD Dryer)	ZR 145	299	17.9	634	200	2.0	-	75	72	2900	2540	2000	1650
	ZR 250	491	29.5	1040	300	3.4	-	72	70	4145	3140	2000	1650
	ZR 275	550	33.0	1165	350	3.8	-	72	70	4265	3140	2000	1650

⁽¹⁾ Reference conditions:

- dry air
- absolute inlet pressure 1 bar(a)
- cooling and air intake temperature 20 °C
- nominal working pressure
- performance of the compressor package measured according to ISO 1217, Third Edition, Annex C

⁽²⁾ Cooling water temperature rise of 15 °C

⁽³⁾ Max. capacity is at reference pressure and

not at max. pressure

- ⁽⁴⁾ Pressure dewpoint is specified for
 - 20 °C cooling air/water temperature
 - relative humidity of 60 %
 - nominal working pressure
 - load level of minimum 50 %
- For VSD: at reference speed

⁽⁵⁾ ± 3 dB(A) measured at a distance of 1 m and according to ISO 2151:2004 and using ISO 9614-2

⁽⁶⁾ Maximum intake / cooling air temperature is 50 °C for

HAT versions

Conversions

- 1 kg = 2.2 lbs
- 1 mm = 0.039 inch
- °F = °C x 9/5 + 32

ZT 110-275 and ZT 132-315 VSD compressors - 50 Hz

	ZT aircooled	Capacity FAD ⁽¹⁾			Installed motor power	Installed fan motor	Pressure dewpoint ⁽³⁾	Noise level ^{*(4)}		Weight	Dimensions L x W x H			
	Type	l/s	m ³ /min	cfm	kW	kW	°C	w/o duct dB(A)	with duct dB(A)	kg	A mm	B mm	C mm	
	50 Hz - 7.5 bar(e)													
FF (with IMD Dryer)	ZT 110	312	18.7	661	110	4.8	-28	72	70	4095	4040	2000	1650	
	ZT 132	360	21.6	763	132	4.8	-29	73	70	4220	4040	2000	1650	
	ZT 145	390	23.4	826	145	4.8	-30	73	71	4360	4040	2000	1650	
	ZT 160	460	27.57	973	160	8.8	-30	77	75	5625	5040	2100	1650	
	ZT 200	563	33.75	1191	200	8.8	-25	77	75	6285	5040	2100	1650	
	ZT 250	705	42.31	1493	250	8.8	-28	77	75	6280	5040	2100	1650	
Pack (w/o IMD Dryer)	ZT 110	314	18.8	665	110	4.8	-	71	70	3585	4040	2000	1650	
	ZT 132	362	21.7	767	132	4.8	-	72	70	3710	4040	2000	1650	
	ZT 145	392	23.5	829	145	4.8	-	72	70	3850	4040	2000	1650	
	ZT 160	460	27.6	973	160	8.8	-	77	75	5185	5040	2100	1650	
	ZT 200	563	33.8	1191	200	8.8	-	77	75	5385	5040	2100	1650	
	ZT 250	705	42.3	1493	250	8.8	-	77	75	5380	5040	2100	1650	
FF (with IMD Dryer)	50 Hz - 8.6 bar(e)													
	ZT 110	281	16.9	595	110	4.8	-28	72	70	4095	4040	2000	1650	
	ZT 132	322	19.3	682	132	4.8	-29	73	70	4220	4040	2000	1650	
	ZT 132 VSD	349	20.9	739	132	4.8	-25/-30	67-71	66-70	4330	4040	2000	1650	
	ZT 145	361	21.6	785	145	4.8	-30	73	71	4360	4040	2000	1650	
	ZT 160	422	25.3	894	160	8.8	-30	77	75	5625	5040	2100	1650	
	ZT 160 VSD	404	24.2	856	160	4.8	-25/-30	67-74	66-71	4330	4040	2000	1650	
	ZT 200	510	30.6	1081	200	8.8	-25	77	75	6285	5040	2100	1650	
	ZT 250	661	39.7	1401	250	8.8	-28	77	75	6280	5040	2100	1650	
	ZT 250 VSD	699	41.9	1480	250	18.5	-25/-30	70-77	68-75	6660	5040	2100	1650	
	ZT 275	696	41.8	1475	275	18.5	-30	77	75	6630	5040	2100	1650	
	ZT 315 VSD	789	47.4	1672	299	18.5	-25/-30	70-78	68-76	6660	5040	2100	1650	
	Pack (w/o IMD Dryer)	ZT 110	281	16.9	595	110	4.8	-	71	70	3585	4040	2000	1650
ZT 132		322	19.3	682	132	4.8	-	72	70	3710	4040	2000	1650	
ZT 132 VSD		354	21.2	750	132	4.8	-	67-74	66-71	3820	4040	2000	1650	
ZT 145		361	21.6	785	145	4.8	-	72	70	3850	4040	2000	1650	
ZT 160		422	25.3	894	160	8.8	-	77	75	5185	5040	2100	1650	
ZT 160 VSD		410	24.6	869	160	4.8	-	67-74	66-71	3820	4040	2000	1650	
ZT 200		510	30.6	1081	200	8.8	-	77	75	5385	5040	2100	1650	
ZT 250		661	39.7	1401	250	8.8	-	77	75	5380	5040	2100	1650	
ZT 250 VSD		699	41.9	1480	250	8.8	-	70-77	68-75	6130	5040	2100	1650	
ZT 275		696	41.8	1475	275	8.8	-	77	75	5580	5040	2100	1650	
ZT 315 VSD		789	47.4	1672	299	8.8	-	70-78	68-76	6130	5040	2100	1650	
FF (with IMD Dryer)		50 Hz - 10 bar(e)												
		ZT 110	260	15.6	551	110	4.8	-28	72	70	4095	4040	2000	1650
	ZT 132	313	18.8	662	132	4.8	-29	73	70	4220	4040	2000	1650	
	ZT 132 VSD	316	19.0	670	132	4.8	-25/-30	67-71	66-70	4330	4040	2000	1650	
	ZT 145	334	20.0	707	145	4.8	-30	73	70	4360	4040	2000	1650	
	ZT 160	389	23.3	823	160	8.8	-30	78	76	5625	5040	2100	1650	
	ZT 160 VSD	370	22.2	784	160	4.8	-25/-30	67-74	66-71	4330	4040	2000	1650	
	ZT 200	490	29.4	1038	200	8.8	-30	78	76	5825	5040	2100	1650	
	ZT 250	608	36.5	1287	250	8.8	-28	78	76	6280	5040	2100	1650	
	ZT 250 VSD	622	37.3	1316	250	18.5	-25/-30	71-78	69-76	6660	5040	2100	1650	
	ZT 275	671	40.2	1420	275	18.5	-30	78	76	6630	5040	2100	1650	
	ZT 315 VSD	709	42.5	1501	299	18.5	-25/-30	71-79	69-77	6660	5040	2100	1650	
	Pack (w/o IMD Dryer)	ZT 110	261	15.7	553	110	4.8	-	71	70	3560	4040	2000	1650
ZT 132		314	18.8	665	132	4.8	-	72	70	3700	4040	2000	1650	
ZT 132 VSD		320	19.2	678	132	4.8	-	67-71	66-70	4050	4040	2000	1650	
ZT 145		336	20.1	711	145	4.8	-	72	70	3850	4040	2000	1650	
ZT 160		389	23.3	823	160	8.8	-	78	76	5185	5040	2100	1650	
ZT 160 VSD		384	23.0	814	160	4.8	-	67-74	66-71	4050	4040	2000	1650	
ZT 200		490	29.4	1038	200	8.8	-	78	76	5385	5040	2100	1650	
ZT 250		608	36.5	1287	250	8.8	-	78	76	5380	5040	2100	1650	
ZT 250 VSD		622	37.3	1316	250	8.8	-	71-78	69-76	6130	5040	2100	1650	
ZT 275		671	40.2	1420	275	8.8	-	78	76	5580	5040	2100	1650	
ZT 315 VSD		709	42.5	1501	299	8.8	-	71-79	69-77	6130	5040	2100	1650	

Oil-free centrifugal compressors, 355-2750 kW, 475-3500 hp

ZH / ZH⁺

Designed to save energy and guarantee reliability, Atlas Copco's ZH/ZH⁺ oil-free centrifugal compressors are provided as complete ready-to-integrate packages including internal piping, integrated coolers, motor, lubrication, inlet guide vanes, control system and 100% matched components. They are just what you need for large compressor rooms of 1-20 MW and for processes with a fluctuating or constant air demand. Choose the ZH/ZH⁺ and put your mind at rest: air is 100% certified oil-free according to ISO 8573-1 CLASS 0 (2010), and the compressors operate reliably even in extremes of temperature and humidity.

CUSTOMER BENEFITS

- **Maximum uptime** – All ZH/ZH⁺ components are easy to maintain, dismantle and re-assemble if required, thus reducing downtime. Advanced control and monitoring possibilities ensure that production interruptions are minimized. In addition, easily accessible major components, minimal service interventions and long overhaul intervals reduce maintenance time and costs.
- **Maximum energy savings** – All components of the ZH/ZH⁺, such as the backward leaning impeller, carbon ring air seals and inlet guide

vanes, are designed to lower the pressure drops and provide the highest air volume with the lowest energy requirement.

- **Easy installation** – The design of the ZH/ZH⁺ includes internal piping, coolers, motor, lubrication, inlet guide vanes and control system: all ready for integration on site. Delivered as a plug-and-run integrated package, the ZH⁺ ensures a low commissioning time, fault-free installation and no external instrument air is required.
- **Advanced control monitoring** – To maximize efficiency and reliability, the Elektronikon[®] controls the main drive motor and regulates system pressure within a predefined and narrow pressure band. The Elektronikon[®] controller can be adapted to your specific needs with extra sensors, digital contacts, fieldbus, Internet and SMS communication functions. In combination with the ES multiple compressor controller, the operation of your complete compressor room is optimized.
- **Certified 100% oil-free** – ZH/ZH⁺ compressors provide you with 100% pure, clean air that complies with ISO 8573-1 CLASS 0 (2010) certification. CLASS 0 means zero risk of contamination; zero risk of damaged or unsafe products; zero risk of losses from operational downtime; and zero risk of damaging your company's hard-won professional reputation. In 2006 Atlas Copco was the first manufacturer in the world to receive such certification on an oil-free compressor.



Functional diagram for the ZH (3-stage) series

- | | | | |
|--------------------|---------------|--------------------|--------------|
| 1 Air filter | 4 Intercooler | 7 Aftercooler | a Oil pump |
| 2 Inlet guide vane | 5 Turbo stage | 8 Blow-off muffler | b Oil cooler |
| 3 Turbo stage | 6 Turbo stage | 9 Oil tank | c Oil filter |

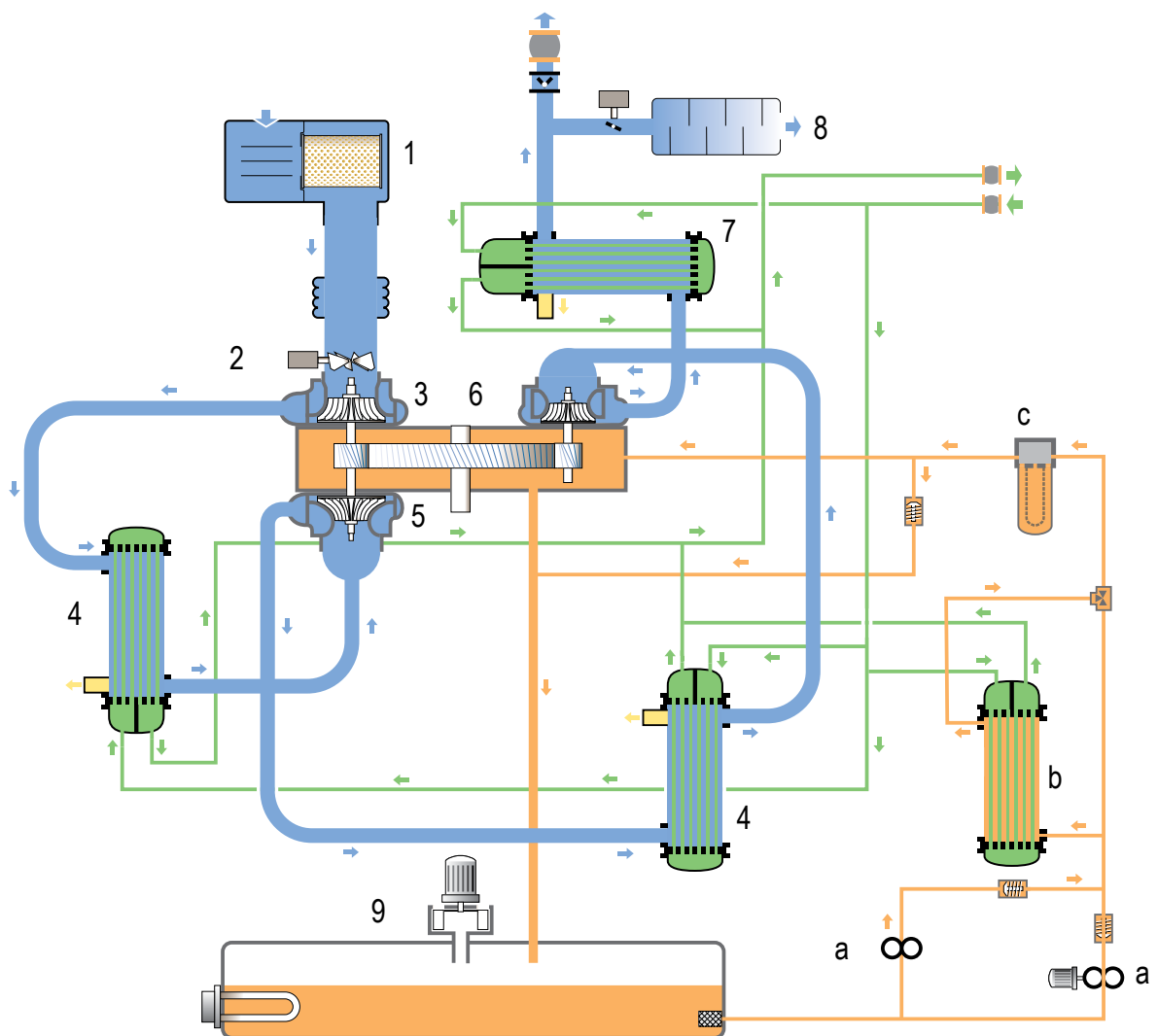

Power-saving inlet guide vane and actuator



Effectively positioned before the 1st stage, with a constant delivery pressure in the control range, it adjusts the volume Capacity FAD to the exact compressed air requirement, saving up to 9% power compared to conventional valve regulation. The reliable servo-motor based actuator looks after an accurate alignment with the variable air demand to ensure these energy savings.

Blow-off regulation for constant pressure applications

The volume Capacity FAD control range of the turbo expands considerably at a constant delivery pressure due to the blow-off function. The most flexible volume Capacity FAD adaption for constant pressure processes.

Type	Maximum working pressure	Volume Capacity FAD ⁽¹⁾		Installed motor power	Noise level ^{*(2)}	Approx. weight ⁽³⁾	Dimensions ⁽³⁾
	bar	l/s	m ³ /hr	kW	db(A)	kg	L x W x H mm
ZH 355-900 & ZH6000/10000 - 9000/15000 - 16000/26000 Centrifugal compressors							
ZH 355	3.5 - 4.6	1320 - 1578	4750 - 5681	355	83	6325	3970 X 2230 X 2230
ZH 400	3.5 - 8	1234 - 1814	4443 - 6531	400	83	6625 - 7225	3970 X 2230 X 2230
ZH 450	3.5 - 9	1297 - 2052	4670 - 7388	450	83	6725 - 7325	3970 X 2230 X 2230
ZH 500	3.5 - 10.4	1349 - 2280	4855 - 8208	500	83	6875 - 7475	3970 X 2230 X 2230
ZH 560	3.5 - 13	1368 - 2548	4924 - 9174	560	83	7475 - 8075	3970 X 2230 X 2230
ZH 630	7 - 13	1555 - 2063	5599 - 7428	630	83	8825	3970 X 2230 X 2230
ZH 710	7 - 13	1770 - 2331	6371 - 8390	710	83	9475	3970 X 2230 X 2230
ZH 800	7 - 13	2011 - 2620	7240 - 9432	800	83	9425	3973 X 2230 X 2230
ZH 900	9 - 10.4	2570 - 2588	9253 - 9316	900	83	9425	3974 X 2230 X 2230
ZH6000/10000 2stage	3.5 - 4.6	1450 - 3275	5200 - 11800	500 - 710	80 - 85	13710-14570	5250x2000x2340
ZH6000/10000 3stage	7 - 10.4	1450 - 3275	5200 - 11800	630 - 1120	80 - 85	13710-14570	5250x2000x2340
ZH9000/15000 2stage	3.5 - 4.6	2225 - 5000	8000 - 18000	710 - 1250	80 - 85	16000-18310	5800x2250x2570
ZH9000/15000 3stage	7 - 10.4	2225 - 5000	8000 - 18000	1000 - 1850	80 - 85	16000-18310	5800x2250x2570
ZH16000/26000 3stage	7 - 10.4	3325 - 7500	12000 - 27000	1600 - 2750	80 - 85	38500	7300x3000x3630
ZH 350+ - ZH 900+ Centrifugal compressors							
ZH 350+	3.5 - 4.6	1320 - 1578	4750 - 5681	355	72	8050	5270 x 2230 x 2230
ZH 400+	3.5 - 8	1234 - 1814	4443 - 6531	400	72	8350 - 8950	5270 x 2230 x 2230
ZH 450+	3.5 - 9	1297 - 2052	4670 - 7388	450	72	8450 - 9050	5270 x 2230 x 2230
ZH 500+	3.5 - 10.4	1349 - 2280	4855 - 8208	500	72	8600 - 9200	5270 x 2230 x 2230
ZH 560+	3.5 - 13	1368 - 2548	4924 - 9174	560	72	9200 - 9800	5270 x 2230 x 2230
ZH 630+	7 - 13	1555 - 2063	5599 - 7428	630	72	9950	5270 x 2230 x 2230
ZH 710+	7 - 13	1770 - 2331	6371 - 8390	710	72	10200	5270 x 2230 x 2230
ZH 800+	7 - 13	2011 - 2620	7240 - 9432	800	72	11150	5270 x 2230 x 2230
ZH 900+	9 - 10.4	2570 - 2588	9253 - 9316	900	72	11150	5270 x 2230 x 2230
ZH6000/10000+ 2stage	3.5 - 4.6	1450 - 3275	5200 - 11800	500 - 710	80 - 85	13710-15120	5250x2120x2400
ZH6000/10000+ 3stage	7 - 10.4	1450 - 3275	5200 - 11800	630 - 1120	80 - 85	13710-15120	5250x2120x2400
ZH9000/15000+ 2stage	3.5 - 4.6	2225 - 5000	8000 - 18000	710 - 1250	80 - 85	16900-19210	5800x2370x2630
ZH9000/15000+ 3stage	7 - 10.4	2225 - 5000	8000 - 18000	1000 - 1850	80 - 85	16900-19210	5800x2370x2630
ZH16000/26000+ 3stage	7 - 10.4	3325 - 7500	12000 - 27000	1600 - 2750	80 - 85	40100	7300x3120x3500

Oil-free high-speed drive centrifugal compressors, 350 kW, 470 hp

ZH 350+

Atlas Copco's ZH 350+ oil-free centrifugal compressors are designed to save you energy. Operating at high speed and high efficiency, they are directly driven by a permanent magnet synchronous motor. Optimal 3-stage compression reduces operating costs to previously unattainable low levels. A further major benefit is that air is 100% certified oil-free according to ISO 8573-1 CLASS 0 (2010). With the ZH 350+ you get a complete plug-and-run package including internal piping, integrated coolers, motor, control system and 100% matched components.

CUSTOMER BENEFITS

- Maximum energy savings** – All components of the ZH 350+ are designed to save energy. The high-speed drive means no oil lubrication, no intermediate gears and fewer rotating components, all of which drive down energy costs. The backward leaning impeller and the carbon ring air seals are designed to lower the pressure drops and provide the highest air volume with the lowest energy requirement.
- Advanced control monitoring** – The compressor controller maximizes efficiency and reliability of the ZH 350+ by controlling the main drive motor and regulating system pressure within a predefined and narrow pressure band. The controller can be adapted to your specific needs with extra sensors, digital contacts, fieldbus, Internet and SMS communication functions. In combination with the ES multiple compressor controller, the operation of your complete compressor room is optimized.
- Maximum uptime** – All ZH 350+ components are easy to maintain, dismantle and re-assemble if required, thus reducing downtime. Advanced control and monitoring possibilities ensure that production interruptions are minimized. In addition, easily accessible major components, minimal service interventions and long overhaul intervals reduce maintenance time and costs.
- Plug-and-run package** – The integrated design of the ZH 350+ includes internal piping, coolers, motor, and control system: all supplied as a ready-to-use package. Installation is fault-free, commissioning time is low and no external instrument air is required. You simply plug and run.
- Certified 100% oil-free** – ZH 350+ compressors provide you with 100% pure, clean air that complies with ISO 8573-1 CLASS 0 (2010) certification. CLASS 0 means zero risk of contamination; zero risk of damaged or unsafe products; zero risk of losses from operational downtime; and zero risk of damaging your company's hard-won professional reputation. In 2006 Atlas Copco was the first manufacturer in the world to receive such certification on an oil-free compressor.



50/60 Hz	Working pressure		Capacity FAD ⁽¹⁾						Installed motor power		Dimensions					
	bar(e)	psig	l/s		cfm		m ³ /h		kW	hp	mm			in		
			Min	Max	Min	Max	Min	Max			A	B	C	A	B	C
ZH 350+	6-9	87-130	700	1100	1483	2330	2520	3960	350	470	2400	2000	2017	94.49	78.74	79.42

Energy recovery control unit for water-cooled oil-free air compressors from 90 to 900 kW.

ER 90-900

Atlas Copco energy recovery control units transfer the energy recovered in the cooling water of oil-free air compressors to your process. The control unit is installed between the compressor and your cooling and heating circuit. The design ensures perfect and easy integration of energy recovery systems in a wide variety of different applications.

CUSTOMER BENEFITS

- Specifically designed to transfer the energy recovered from the oil-free compressor to your process.
- Ultimate reliability under the harshest operating conditions.
- Single interface between your compressed air system and your process.
- Regulation of compressor cooling water pressure and temperature to keep the compressed air system working optimally.
- Compressors operate independently from your heat requirement process.
- Easy to guarantee optimal quality of cooling water from compressor(s).
- Up to four ZR compressors can be connected to one energy recovery control unit.
- Standard set-up can be extended with a number of application specific options.
- Designed, manufactured and tested in accordance with ISO 9001 and ISO 1400.
- Superior quality by design ensures long and trouble-free life at the lowest operating costs:
 - Stainless steel plate heat exchangers.
 - Variable-speed driven pumps.
 - State-of-the-art control system.
- Maximum efficiency and reliability:
 - Elektronikon® controller can be adapted to specific needs with digital contacts, fieldbus, Internet and SMS communication functions.



Serving the mining industry with energy efficient solutions



OIL-FREE COMPRESSORS FOR LOW & HIGH PRESSURE APPLICATIONS

We have an energy efficient solution for every demand, be it waste water treatment, pneumatic conveying, mining, PET bottle blowing or any application requiring low or high pressure compressed air.

Atlas Copco's continuous drive for energy efficiency to reduce your energy cost, has made innovation the heart of Atlas Copco's values and for a century now, we have been at the forefront of compression technology thanks to a number of ground-breaking introductions.

Solutions for low and high pressures

For operations which require a lot of air but with a low over-pressure, it is worth using special low-pressure systems.

They provide stable system pressure and an efficient air supply without disruptive pulsations or power drops, which occur when the compressed air diverts from the normal air network and the demand is controlled by a buffer container and a blow-off system. Our low-pressure systems are suitable for pressure increases of just above 0, up to 4 bar. So you can supply powders and granules, for example, gently cool and dry products, or aerate sewage plants.

The risk of bottle manufacturers and bottlers contaminating their products with traces of oil due to unclean compressed air is reduced to zero. You'll find details of these and other machines for high and low pressure on the following pages.

The design of our ZB centrifugal compressors is particularly efficient. With the contactless electromagnetic position of the motor, which is located on the motor shaft itself along with the impeller, they achieve efficiencies of over 90%. The gearless machines are non-wearing and keep maintenance costs low.

A precise analysis of the requirements will show which solution is best for the application in question. Investing more in an expensive system often pays for itself in the first one to two years due to the improved energy efficiency. We also offer efficient compressors for high pressures from 20 to 40 bar. We would even go so far as to say that, with our Class 0 certificate for oil-free machines and some constructive subtleties, our ZD high pressure compressor is a safe and energy-efficient compressed air solution for manufacturing PET bottles!



**Oil-free rotary screw compressors, 22-500 kW / 30-700 hp
ZE/ZA (VSD)**

Page 85



**Oil-free positive displacement screw blowers, 7-132 kW,
10-180 hp
ZS**

Page 86



**Oil-free Variable Speed Drive positive displacement screw blowers, 18-355 kW, 25-475 hp
ZS+ VSD**

Page 87



**Oil-free Variable Speed Drive centrifugal air compressors, 7-132kW, 10-180 hp
ZB 100-160 VSD**

Page 88



**Oil-less Multistage centrifugal blowers, 4-2600 kW, 5-3600 hp
ZM 31-246**

Page 89



**Oil-free reciprocating compressors up to 150 bar (2575 psig), 37-560 kW,
50-750 hp
HX / HN**

Page 92



**Oil-free reciprocating trunk-piston compressors, up to 450 bar (a) (6527 psia), 37 kW
DM**

Page 90



**Oil-free reciprocating piston compressors, up to 40 bar (580 psig), 37-275 kW / 50-368 hp
P**

Page 93



**Oil-free reciprocating piston compressors, up to 45 bar (652 psig) 37-315 kW / 50-422 hp
DX / DN**

Page 91



**Oil-free screw and reciprocating piston compressors, up to 40 bar (580 psig), 143 - 712 kW / 190 - 954 hp
ZD**

Page 95

Oil-free rotary screw compressors, 22-500 kW / 30-700 hp ZE/ZA (VSD)

Especially in harsh and dusty environments, a reliable supply of 100% certified oil-free compressed air is critical to ensure production continuity. Atlas Copco's low pressure ZE/ZA compressors fulfill this demand by offering a constant air Capacity FAD at minimal energy costs. Integrated Variable Speed Drive (VSD) variants precisely and automatically tune the compressor Capacity FAD to the process air demand and hence limit the energy consumption to the absolute minimum possible.

CUSTOMER BENEFITS

- **Highest reliability** – ZE/ZA compressors stand for durability and reliability. They incorporate Atlas Copco's proven screw technology, stainless steel coolers, AGMA A4/DIN 5 gears and state-of-the-art electrical drive systems, all of which contribute to overall high reliability. ZE/ZA compressors are built using long-standing internal engineering practices, and are manufactured and tested according ISO 9001.
- **Certified 100% oil-free** – ZE/ZA compressors provide you with 100% pure, clean air that complies with ISO 8573-1 CLASS 0 (2010) certification. CLASS 0 means zero risk of contamination; zero risk of damaged or unsafe products; zero risk of losses from operational downtime; and zero risk of damaging your company's hard-won professional reputation. In 2006 Atlas Copco was the first manufacturer in the world to receive such certification on an oil-free compressor.
- **Reduced energy costs** – With an air circuit designed to avoid and reduce pressure drops, the ZE/ZA is built to save energy. Features like VSD drive and state-of-the-art oil-free compression element greatly enhance energy savings.
- **Easy installation** – The compact design eliminates the need for extras and reduces installation to an absolute minimum, saving you time and money. Built for easy integration in your existing compressed air network, ZE/ZA compressors are up and running in no time.



Technical specifications	Metric	Imperial
Capacity FAD	67-2105 l/s	67-2105 l/s
Capacity FAD	241 - 7578 m ³ /h	141,7-4455,86 cfm
Working pressure	1-4 bar(e)	14,5-58 psig
Installed motor power	22 - 500 kW	30 - 700 hp

Oil-free positive displacement screw blowers, 7-132kW, 10-180hp

ZS

Atlas Copco's ZS blowers provide a continuous and reliable supply of 100% oil-free air – certified according to ISO 8573-1 CLASS 0 (2010). Integrating the proven benefits of screw technology, the ZS range will cut your energy costs by an average of 30% when compared to lobe technology.

CUSTOMER BENEFITS

- Reliability** – Incorporating our proven screw technology and long-standing internal engineering practices, and designed, manufactured and tested in accordance with ISO 9001, the ZS gives you 24/7 reliability over its long lifetime.
- High efficiency** – Integrating the proven benefits of screw technology, the ZS range reduces energy costs by an average of 30% when compared to lobe technology.
- Certified 100% oil-free** – ZS blowers provide you with 100% pure, clean air that complies with ISO 8573-1 CLASS 0 (2010) certification. CLASS 0 means zero risk of contamination; zero risk of damaged or unsafe products; zero risk of losses from operational downtime; and zero risk of damaging your company's hard-won professional reputation. In 2006 Atlas Copco was the first manufacturer in the world to receive such certification on an oil-free compressor.
- Easy installation** – Built for smooth integration in your existing compressed air network, ZS blowers are up and running in no time.



Technical specifications	Metric	Imperial
Capacity FAD	75 - 1292 l/s	75 - 1292 l/s
Capacity FAD	271 - 4651 m ³ /h	48 - 2731 cfm
Working pressure	0.3 - 1 bar(e)	4 - 14.5 psig
Installed motor power	18.5 - 160 kW	25 - 200 hp

Oil-free Variable Speed Drive positive displacement screw blowers, 18-355 kW, 25-475 hp

ZS⁺ VSD

Atlas Copco's ZS⁺ VSD blowers balance the two key prerequisites when choosing a blower: reliability and energy efficiency.

Integrating the proven benefits of screw technology, the ZS⁺ VSD reduces energy costs by an average of 30% when compared to lobe technology. But that's not all. The ZS⁺ VSD offers 100% oil-free air – TÜV-certified according to ISO 8573-1 CLASS 0 (2010) – which is absolutely essential to avoid contamination and keep your production running smoothly. The ZS⁺ VSD is supplied as a state-of-the-art, ready-to-run package with completely integrated VSD convertor and proven Elektronikon® controller.

CUSTOMER BENEFITS

- **High reliability** – Incorporating our proven screw technology and longstanding internal engineering practices, and designed, manufactured and tested in accordance with ISO 9001, the ZS⁺ VSD gives you 24/7 reliability over its long lifetime.
- **Maximum energy savings** – Integrating the proven benefits of screw technology, the ZS⁺ VSD range

reduces energy costs by an average of 30% when compared to lobe technology. VSD technology closely follows the air demand by automatically adjusting the motor speed and lowering system pressure, giving you even greater energy savings.

- **Certified 100% oil-free** – ZS⁺ VSD blowers provide you with 100% pure, clean air that complies with ISO 8573-1 CLASS 0 (2010) certification. CLASS 0 means zero risk of contamination; zero risk of damaged or unsafe products; zero risk of losses from operational downtime; and zero risk of damaging your company's hard-won professional reputation. In 2006 Atlas Copco was the first manufacturer in the world to receive such certification on an oil-free compressor.
- **Easy installation** – Delivered ready for use, ZS⁺ VSD blowers come as all-in-one packages including the state-of-the-art Elektronikon® controller, integrated converter, forklift slots, check valve, air filter and silencers. The compact design eliminates the need for extras and reduces installation to an absolute minimum, saving you time and money.
- **Quiet operation** – Vibration and noise levels are low, resulting in a pleasant working environment for your operators.



Technical specifications	Metric	Imperial
Capacity FAD	79-2583 l/s	79 - 1272 l/s
Capacity FAD	284-9300 m ³ /h	152-5468 cfm
Working pressure	0.3 - 1.2 bar(e)	4 - 17 psig
Installed motor power	22-355 kW	30-475 hp

Oil-free Variable Speed Drive centrifugal air compressors, 100-160 kW, 135-215 hp

ZB 100-160 VSD

Atlas Copco's low pressure ZB 100-160 VSD blowers guarantee a continuous, highly reliable, energy-efficient and 100% oil-free air supply – certified according to ISO 8573-1 CLASS 0 (2010). These blowers are directly driven by a permanent magnet synchronous motor, which is vastly superior to conventional types. Moreover, the unique stainless steel backward lean impeller has integrated labyrinth seals which lead to high efficiency and minimal air leakage. The ZB 100-160 VSD is supplied as an all-in-one, ready-to-run package with a small footprint. Vibration and noise levels are low, resulting in an agreeable working environment for your operators.

CUSTOMER BENEFITS

- **High reliability** –Thanks to innovative magnetic bearings, low vibration turbo technology and integrated Variable Speed Drive, ZB 100-160 VSD blowers provide exceptional reliability and production continuity.
- **Maximum energy savings** – Install a ZB 100-160 VSD and benefit from reduced costs. The magnetic bearing design coupled with the turbo compression system provides the highest air volume at the lowest energy consumption. Enjoy extra energy savings with integrated Variable Speed Drive technology, which automatically tunes the compressed air Capacity FAD precisely to air demand.



ZB 100 VSD



- **Certified 100% oil-free** – All ZB blowers provide you with 100% pure, clean air that complies with ISO 8573-1 CLASS 0 (2010) certification. CLASS 0 means zero risk of contamination; zero risk of damaged or unsafe products; zero risk of losses from operational downtime; and zero risk of damaging your company's hard-won professional reputation. In 2006 Atlas Copco was the first manufacturer in the world to receive such certification on an oil-free compressor. ,
- **Easy installation** – ZB 100-160 blowers are delivered ready for use. The all-in-one package includes a powerful PLC controller, integrated VSD, forklift slots, check valve, air filter, blow-off valve and silencers. ,
- **Easy maintenance** – ZB 100-160 blowers will save you time and costs due to easy serviceability. ,
- **Quiet operation** – Low vibration and noise levels provides a pleasant working environment for your operators.

The ZB module concept

For larger Capacity FAD, multiple ZB VSD units can be connected in parallel.

- Higher availability
- Reliability through redundancy
- Wider operating range and high efficiency
- Extremely low Noise level*
- Space-saving
- Expandable

The unique stainless steel turbo impeller with backward-curved blade design is a registered Atlas Copco patent with labyrinth seals for maximum efficiency and minimal air loss.

ZB – Turbo power

ZB BLOWER RANGE OVERVIEW

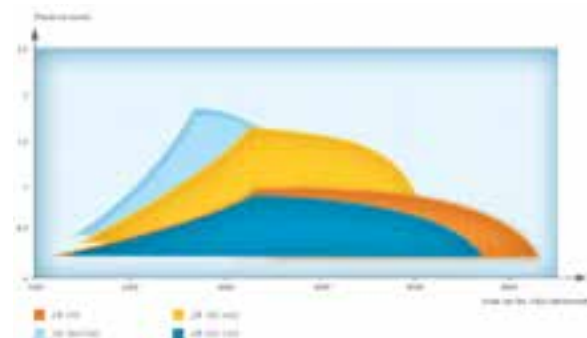

Oil-less Multistage centrifugal blowers, 4-2600 kW, 5-3 600 hp

ZM 31-246

Atlas Copco's ZM oil-less multistage centrifugal blowers are working successfully in thousands of installations around the world. These reliable blowers are ideal for applications ranging from air to gas and pressure to vacuum. The ZM are equipped with all the necessary accessories such as motor, valves, filters and skid as well as local or networked control panels to provide a complete working system.

- **Extensive product choice** – Configuration options ensure we can offer the best possible solution possible to meet your need.
- **Wide application range** – ZM centrifugal blowers are working reliably in thousands of installations around the world. They are suitable both for air and gas applications and operate in pressure or vacuum configurations.
- **Complete solution** – ZM blowers are equipped with all the necessary accessories such as motor, valves, filters and skid as well as local or networked control panels to provide a complete working system matched to the application.

CUSTOMER BENEFITS

- **Durability and Performance** – Solidly constructed out of premium components they will run continuously with unbeatable cost-effectiveness.
- **Minimum maintenance requirements** – Save time and cost due to minimal downtime.



Overview of range

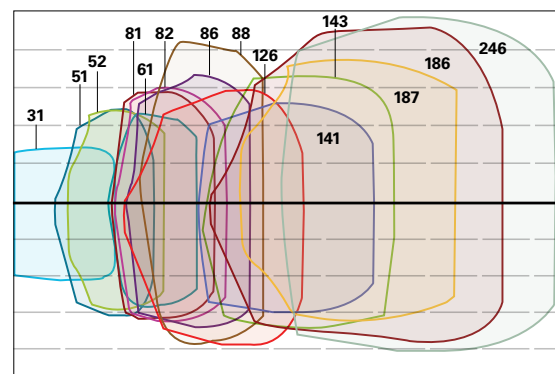

Oil-free reciprocating trunk-piston compressors, up to 450 bar (a) (6527 psia), 37 kW DM

Atlas Copco's DM oil free reciprocating compressors will meet your needs for high pressure compression up to 351 bar(a).

Compact, with very low vibration levels and a sealed crankcase, DM compressors are ideal for the compression of natural gas, processed biogas, hydrogen.

CUSTOMER BENEFITS

- **High degree of safety** – Its revolutionary “oil-less” technology guarantees that oil does not contaminate the gas. Its hermetically sealed crankcase ensures no emission of gases to the atmosphere, even gases with a low molecular weight.
- **High reliability** – Low compression ratios in the individual stages result in low thermal load and high reliability. The Scotch yoke principle means balanced forces and minimal vibration.

- **Easy installation** – Very compact, frame-mounted and incorporating anti-vibration pads, DM compressors come as complete all-in packages with a small footprint and are simple to install without the need for complex piping arrangements.
- **Low cost of ownership** due to no water consumption and high efficiency.
- **Low maintenance** – An advanced maintenance concept ensures short downtimes.
- **A wide array of solutions** – DM compressors are available for Inlet pressure, 1 to 40 bars, and 2 to 5 stage configurations. They are suitable for diverse applications such as CNG refueling stations and gas applications (e.g. Ex-zone 2 or optionally Ex-zone 1).

Technical specifications	Metric	Imperial
Capacity FAD	7.5 - 61.4 l/s	7.5 - 61.4 l/s
Working pressure	1 - 450 bar (a)	14.5 - 6527 psia
Installed motor power	37 kW	50 hp
Capacity	27 - 203 Nm ³ /h	16 - 124 scfm
Inlet pressure	1 - 40 bar	14.5 - 580 psi
Gases handled	natural gas, processed biogas, hydrogen	natural gas, processed biogas, hydrogen



Oil-free reciprocating piston compressors, up to 45 bar (652 psig) 37-315 kW / 50-422 hp DX / DN

Atlas Copco's DX/DN oil-free reciprocating booster is the alliance of an extremely robust design with the best of technology in terms of packaging and equipment. DX/DN is your best partner in air and nitrogen compression from 7 to 45 bars. Available as a mono-stage or two-stage machine, it perfectly suits a wide variety of requirements in terms of capacity and pressures. You will appreciate its canopy for its silencing properties and you will easily adopt the concrete frame that makes installation so easy. DX/DN compressors can be fitted downstream from an Atlas Copco Z compressor to create a complete package running from 1 to 40/45 bar.

CUSTOMER BENEFITS

- Certified 100% oil-free** – DX/DN boosters provide you with 100% pure, clean air that complies with ISO 8573-1 CLASS 0 (2010) certification. CLASS 0 means zero risk of contamination; zero risk of damaged or unsafe products; zero risk of losses from operational downtime; and zero risk of damaging your company's hard-won professional reputation.
- Nitrogen-ready** – We adapt the piston rings and packing rings to nitrogen composition, dew point and purity. We supply DX/DN with or without a canopy (gas detection). Inlet dewpoints from -10°C/+14°F to "bone dry" gas are handled.
- Energy savings** – DX/DN boosters are also available in Variable Speed Drive versions, allowing for on average 35% energy savings due to:
 - Unload losses are reduced to a minimum
 - Load/no load transition losses are eliminated
 - Precise pressure control allows a tighter pressure band and a lower average working pressure, resulting in reduced energy consumption.
- Easy installation** – Fitted on a concrete base-plate, the DX/DN booster comes as an all-in-one package. The compact design eliminates the need for extras and accelerates installation, saving you time and money.
- High reliability** – Low piston speed and low interstage temperatures preserve the inner parts of the machines. The horizontal design ensures a low vibration/pulsation level for increased reliability. Design is close to API 618.
- Advanced control and monitoring** – The advanced Elektronikon® system helps you keep control of costs by monitoring overall system performance through service indications, malfunctions alarms and safety shutdowns.

Technical specifications	Metric	Imperial
Capacity FAD	82 - 5738 l/s	82 - 5738 l/s
Working pressure	12 - 45 bar (a)	174 - 652 psia
Installed motor power	37 - 315 kW	50 - 422 hp
Capacity FAD	295 - 20657 m³/h	174 - 12158 cfm
Capacity	350 - 19000 Nm³/h	206 - 11183 scfm
Inlet pressure	6 - 25 bar	87 - 363 psi
Gases handled	air, nitrogen	air, nitrogen



Oil-free reciprocating compressors, up to 150 bar (2175 psig) up to 560 kW - 750 hp HX / HN

Atlas Copco's HX/HN oil-free reciprocating compressors are extremely reliable solutions for air, nitrogen, CO/CO₂, methane, hydrogen and argon. Designed for 24/24 industrial service, with minimal maintenance cost and long overhaul intervals, HX/HN compressors can work in a most efficient and cost-effective way under difficult site conditions.

CUSTOMER BENEFITS

- **Oil-free** – Thanks to their PTFE piston rings and long distance pieces, the compression chambers are perfectly oil-free. HX/HN compressors are the right solution when compressed air is in contact with the end product (drinkable water, gases).
- **Energy saving** – Reciprocating technology ensures excellent volumetric efficiency and economic operation in terms of energy.

- **Flexibility** – A wide variety of regulation systems adjust the capacity rate according to the real utilization of the machine: by stepped regulation (valve unloading); by-pass valve; variable speed drive; or a combination of the above solutions.
- **High reliability** – Low piston speed and low interstage temperatures preserve the inner parts of the machines. The horizontal design ensures a low vibration/pulsation for increased reliability. Design is close to API 618.
- **Adaptability to your application** – We can adapt the machine's internal parts and material to your gas composition requirements or to different inlet pressures. We can also adapt containers for rental equipment or in complete packages including dryer, filters and control panels. HX/HN compressors can work in difficult environments: outdoor, indoor, refineries, deserts (high inlet temperatures) and sandy environments.
- **Easy maintenance** – Horizontal design – safe and comfortable for operators – long service intervals.



Technical specifications	Metric	Imperial
Capacity FAD	45 - 3020 l/s	45 - 3020 l/s
Working pressure	10 - 150 bar(e)	145 - 2175 psig
Installed motor power	37 - 560 kW	50 - 750 HP
Capacity FAD	163 - 16500 m ³ /h	96 - 9712 cfm
Capacity	150 - 15000 Nm ³ /h	94 - 5886 scfm
Inlet pressure	1 - 24 bar	14.5 - 348 psi
Gases handled	air, nitrogen, argon, carbon monoxide, carbon dioxide, hydrogen, argon, methane, biomethane	

Oil-free reciprocating piston compressors, up to 40 bar (580 psig), 37-275 kW / 50-368 hp

P

Atlas Copco's P oil-free reciprocating compressors are a reference in the market for reliability and low cost of ownership. They deliver high-purity oil-free air for discharge pressures between 25 and 40 bar. Sturdy and designed for continuous industrial operation, P compressors deliver air safely, constantly and at low cost. Up to 160 kW, P compressors come as very compact 3-stage machines. Above 160 kW, with the addition of an oil free screw unit in the first stage, they come as 4-stage machines. This innovative approach results in unrivalled benefits, maximizing Capacity FAD in compact plug & play units.

CUSTOMER BENEFITS

- **100% oil-free** – Thanks to PTFE piston rings and long-distance pieces, the compression chambers are perfectly oil-free.
- **Maximum energy savings** – Reciprocating technology ensures excellent volumetric efficiency and economic operation in terms of energy. In addition, with the Elektronikon® controller you can

adjust the required discharge pressure between 25 bar (362 psig) and 40 bar (580 psig) to reduce energy costs.

- **Advanced control and monitoring** – The advanced Elektronikon® system helps you keep control of costs by monitoring overall system performance through service indications, malfunction alarms and safety shutdowns.
- **High reliability** – Low piston speed and low inter-stage temperatures preserve the internal components. The horizontal design ensures low vibration/pulsation levels for increased reliability. Design is close to API 618.
- **Low maintenance** – The horizontal design is safe and comfortable for operators and maintenance personnel. Long service intervals reduce maintenance time and cost.
- **Easy installation** – Each P compressor is delivered as a complete package with no reassembly on site. Installation is fast, straightforward and safe. P compressors are fitted on a skid and can be installed on a suitable industrial floor with chemical bolts. This eliminates skid vibrations and preserves the motor and mechanical parts.



Model	Discharge pressure		Capacity FAD		
	bar(e)	psig	l/s**	m ³ /h**	cfm**
50 Hz					
P 37-50	40	580	45	162	96
P 45-50	40	580	58	209	123
P 55-50	40	580	72	259	153
P 65-50	40	580	89	320	189
P 90-50	40	580	125	450	265
P 110-50	40	580	159	572	337
P 132-50	40	580	190	684	403
P 160-50	40	580	217	781	460
P 180-50	40	580	247	889	523
P 230-50	40	580	328	1181	695
P 275-50	40	580	381	1372	807
60 Hz					
P 37-60	40	580	52	187	110
P 45-60	40	580	69	248	146
P 65-60	40	580	90	324	191
P 75-60	40	580	119	428	252
P 90-60	40	580	150	540	318
P 110-60	40	580	183	659	388
P 132-60	40	580	205	738	434
P 160-60	40	580	218	785	462
P 180-60	40	580	234	842	496
P 230-60	40	580	323	1163	684
P 255-60	40	580	367	1321	778

** Reference conditions*

Ambient temperature & cooling water: 20°C, 68°F

Suction pressure: 1 bar(e) (14.5 psig)

Relative humidity: 0%

*** Reference conditions according to ISO 1217, Edition 4, Annex C stipulating the Capacity FAD measurement at the outlet of the package, net of all losses.*

Standard limitations:

Altitude: 1000 m (3200 feet)

Standard equipment: up to 50°C (122°F) ambient temperature

Oil-free screw and reciprocating piston compressors, up to 40 bar (580 psig), 143 - 712 kW / 190 - 954 hp ZD

Atlas Copco's ZD is the alliance of the world renowned ZR screw compressor, which delivers quality dry air at medium pressure, and the highly efficient D booster which brings the air to 40 bar. ZD represents a quantum leap in reciprocating technology. It is a champion in energy saving and its design is revolutionary. You will appreciate its silencing canopy and its concrete baseplate that makes installation so easy. With its numerous versions and versatility, ZD brings tremendous benefits to your bottom line.

CUSTOMER BENEFITS

- **Certified 100% oil-free** – ZD compressors provide you with 100% pure, clean air that complies with ISO 8573-1 CLASS 0 (2010) certification. CLASS 0 means zero risk of contamination; zero risk of damaged or unsafe products; zero risk of losses from operational downtime; and zero risk of damaging your company's hard-won professional reputation. In 2006 Atlas Copco was the first manufacturer in the world to receive such certification on an oil-free compressor.
- **High reliability** – The ZD's reliability is based on several fundamentals. The first compression stages are rotary, which are world renowned for reliability. Air is dried at the outlet of the screw

compressor, so only dry air enters the D booster, eliminating problems linked to condensates. The D booster's horizontal design, with low vibration levels, ensures long life of internal components.

- **Maximum energy savings** – Being a 4-stage configuration, the ZD is 7% more efficient in terms of energy than the typical 3-stage configuration. In addition you can further reduce energy costs by adjusting the required discharge pressure between 25 bar (362 psig) and 40 bar (580 psig). ZD is also available in a Variable Speed Drive (VSD) version, enabling on average 35% energy savings. For blowing machines equipped with air recovery systems, re-injecting the air back to the booster allows further significant energy savings.
- **Advanced control and monitoring** – To maximize efficiency and reliability, the Elektronikon® controls the main drive motor and regulates system pressure within a predefined and narrow pressure band. The Elektronikon® controller can be adapted to your specific needs with extra sensors, digital contacts, fieldbus and SMS communication functions. In combination with the ES multiple compressor controller, the operation of your complete compressor room is optimized.
- **A wide array of solutions for your compressor room** – ZD allows you to manage your medium pressure and high pressure networks separately, which optimizes your investment and floor space.
- **Low maintenance** – For air-cooled versions, no external cooling system is needed, saving on investment, maintenance and water consumption.



The below data are for a discharge pressure of 40 bar (e)

Discharge pressure 40 bar /580 PSIG	FAD*			Shaft input at ref. cond.	Pressure dew point at 40 bar > to	Noise level***
	l/s	m ³ /h	cfm			
50 Hz						
ZD 800-50	220	792	466	143	3	73.7
ZD 1000-50	264	950	560	166	3	75.6
ZD 1200-50	334	1202	708	210	3	76.0
ZD 1400-50	401	1444	849	254	3	75.9
ZD 1600-50	445	1602	943	281	3	75.9
ZD 2100-50	627	2257	1329	384	3	81.2
ZD 2500-50	687	2473	1456	422	3	81.2
ZD 2750-50	779	2804	1651	488	3	82.2
ZD 3050-50	844	3038	1788	512	3	81.2
ZD 3350-50	937	3373	1986	571	3	81.2
ZD 3750-50	1074	3866	2276	678	3	83.1
ZD 4000-50	1114	4010	2360	712	3	84.0
60 Hz						
ZD 800-60	235	846	498	153	3	73.9
ZD 1000-60	287	1033	608	182	3	75.7
ZD 1200-60	317	1141	672	200	3	76.6
ZD 1400-60	398	1433	843	253	3	77.3
ZD 1600-60	457	1645	968	288	3	75.9
ZD 1900-60	547	1969	1159	389	3	80.7
ZD 2300-60	639	2300	1354	489	3	82.2
ZD 2500-60	725	2610	1536	441	3	81.7
ZD 3100-60	857	3085	1816	520	3	81.7
ZD 3500-60	951	3424	2016	585	3	83.8
ZD 4000-60	1141	4108	2418	722	3	84.0
VSD****						
ZD 1200 VSD	146/320	529/1152	311/678	94/208	3	77.3
ZD 1400 VSD	139/382	500/1375	294/809	94/255	3	77.3
ZD 2300 VSD	308/625	1109/2250	652/1324	193/397	3	83.9
ZD 2800 VSD	308/738	1109/2657	652/1564	193/481	3	83.9
ZD 3500 VSD	440/978	1584/3521	932/2072	270/607	3	83.9
ZD 4100 VSD	440/1099	1584/3957	932/2329	270/699	3	83.9

ZD models	Overall dimensions (machines side by side)		
	A	B	C
50 Hz			
ZD 800-50	3460	4390	2185
ZD 1000-50	3900	4590	2130
ZD 1200-50	3900	4590	2130
ZD 1400-50	4826	5003	2083
ZD 1600-50	4826	5003	2083
ZD 2100-50	4886	5345	2134
ZD 2500-50	4886	5345	2134
ZD 2750-50	4886	5345	2134
ZD 3050-50	5980	5688	2400
ZD 3350-50	5980	5688	2400
ZD 3750-50	6843	5885	2578
ZD 4000-50	6843	5885	2578
60 Hz			
ZD 800-60	3460	4390	2185
ZD 1000-60	3900	4590	2130
ZD 1200-60	3900	4590	2130
ZD 1400-60	3905	4920	2083
ZD 1600-60	4826	5003	2083
ZD 1900-60	4886	5345	2134
ZD 2300-60	4886	5345	2134
ZD 2500-60	4886	5345	2134
ZD 3100-60	5980	5688	2400
ZD 3500-60	5980	5688	2400
ZD 4000-60	6843	5885	2578
VSD****			
ZD 1200 VSD**	3900	4590	2130
ZD 1400 VSD	3905	4920	2083
ZD 2300 VSD	4886	5345	2134
ZD 2800 VSD	4886	5345	2134
ZD 3500 VSD	6843	5885	2578
ZD 4100 VSD	6843	5885	2083

* At reference conditions and according to ISO 1217.

**Please consult Atlas Copco

***A-weighted Noise level* LpA, sound power level LwA, uncertainty + 3dB, reference 20 µ Pa, according to ISO 3746

(for low voltage motors)

****At minimum/maximum speeds

Reference conditions:

- Inlet pressure: 1 bar(a)
- Relative air humidity: 0%
- Air inlet temperature: 20°C
- Cooling water inlet temperature: 20°C
- Nominal effective working pressure: 40 bar

ZD plus and ZD RI ranges offer numerous combinations.

Please contact your local Atlas Copco Customer

Centre at

www.atlascopco.com for a customized selection.

Serving the automotive industry with energy efficient solutions

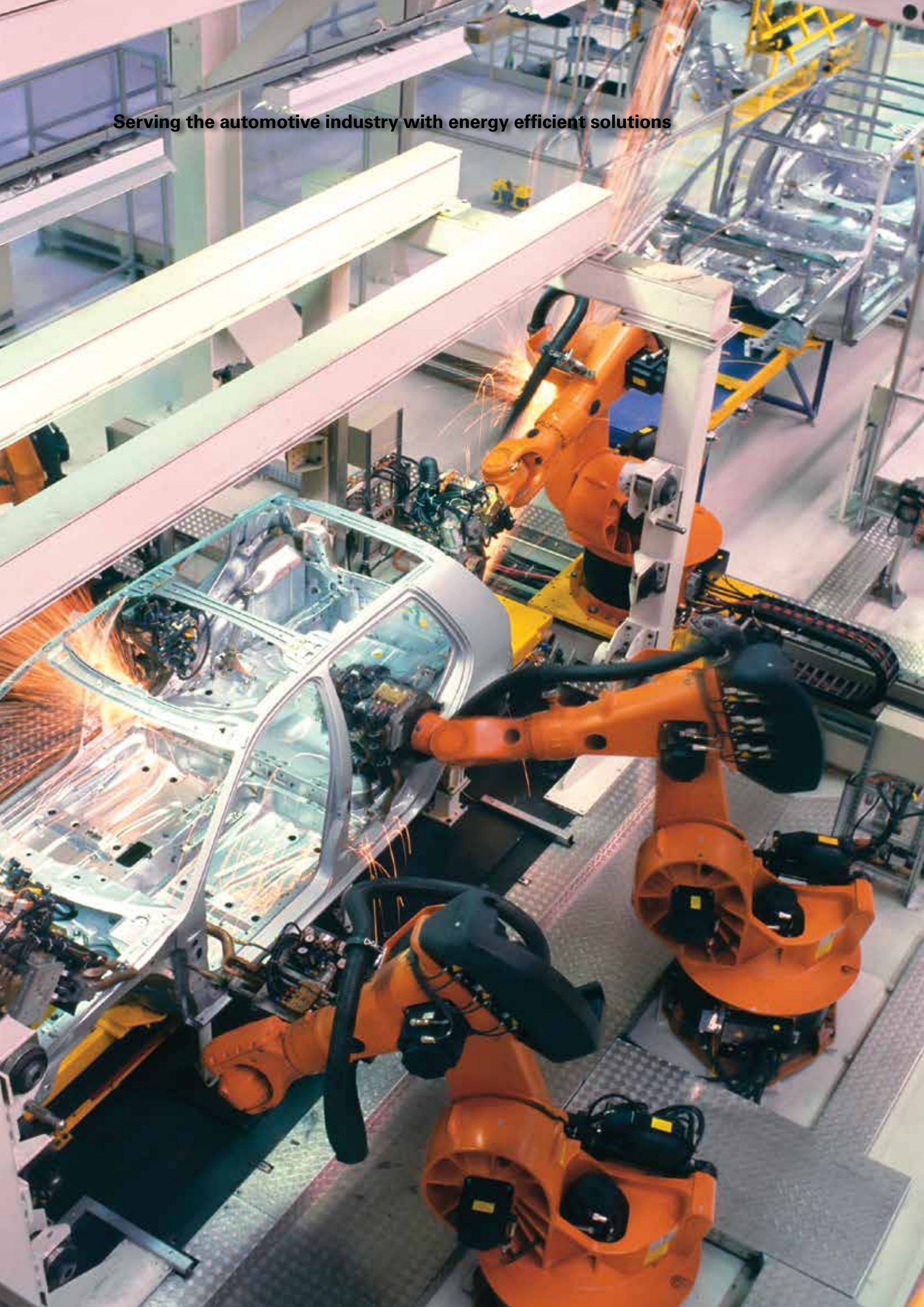

MEDICAL EQUIPMENT

Whether you work in a hospital, a dental practice, a veterinary lab or a clinical work environment, maximum reliability is your main priority.

To successfully perform clinical work and make sure your equipment functions effectively, you rely on ultra-clean air. Set to meet your specific demands and suit a variety of applications, Atlas Copco offers a full range of state-of-the-art solutions to produce pure medical, breathing and surgical air as well as vacuum.

Check www.atlascopco.com/medical for more information on our dedicated product offer for this segment.

**Medical Air Plant
uAIR**

Page 100

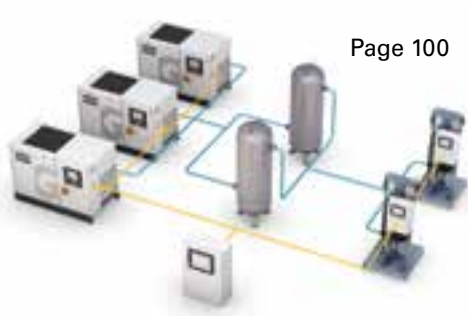

**Oil-free piston
compressors for medical
applications
LF-MED**

Page 103



**Oil-free scroll
compressors for medical
applications.
SF-MED**

Page 104



**Oil-free tooth compressors
for medical applications.
ZT-MED**

Page 105



**Water-injected screw
compressors for medical
applications
AQ-MED**

Page 106



**Screw compressors
for medical
applications
GA MED**

Page 107



**Medical Air Purifiers
MED / MED+**

Page 109



**Medical Vacuum
Plant
mVAC**

Page 111



Medical Air Plant

uAIR

The critical field of patient care requires that ultra-clean, purified medical air is delivered to operating theatres and hospital beds with absolute reliability. The medical air supply in a hospital is a vital life-support service, maintaining respiration of the critically ill during mechanical ventilation. When it comes to people, you can't afford to compromise, which is why oil-free compressed air is the obvious choice.

CUSTOMER BENEFITS

Medically certified - Medical Air Plant complies with the most demanding standards and regulations such as:

- Medical Device Directive MDD 93/42/EEC.
- EN ISO 7396-1.
- ISO 14971.
- Health Technical Memorandums HTM 02-01 and HTM 2022.

Furthermore, it is designed and manufactured according to ISO 9001, ISO 14001 and the ISO 13485:2003 quality management system.

Redundancy scheme - The Medical Air Plant complying with ISO 7396-1 and HTM 02-01 is provided with at least two standby compressors and one backup purifier.

Energy-efficient - As the manufacturer of all the components (compressors, purifiers, control system, etc...) in our Medical Air Plant, our complete system packages fully integrate function between components.

Unsurpassed purity - Built to exacting standards, Atlas Copco's Medical Air Plant is engineered to

provide certified medical air, even in situations where the air intake may contain high concentrations of ambient pollution.



Oil-free – risk free - Medical Air Plants with oil-free compressors offer zero risk for patients; zero risk of contaminating hospital pipelines; zero risk of damaging connected equipment (e.g. anesthesia machines) and zero risk of damaging your hospital hard-won professional reputation.

Widest range - We offer the widest range of pressure (up to 13 bar) and flow (up to 200 l/s), using four different technologies to produce 100% oil-free air: piston - tooth - scroll - water injected.

ES-Medical central controller

The advanced ES-Medical central controller supervises the complete medical installation (including compressors, dryers and vessels) and is specially designed to make plant complying with medical regulations.

- Full compliance with ISO7396-1, Chapter #6 "Monitoring and Alarm signals"
- Monitoring "Medical" and "Surgical" air lines
- Full integration with Building Management System and external Alarms systems
- Remote monitoring and connectivity functions
- Plug and play
- Internet-based visualization using a simple Ethernet connection
- Increased reliability, new safety function implemented: Emergency
- Force Local, internal logging and others
- Easy readout of the CO / CO₂ / flow sensors



Medical Air Plant



ES-Medical central controller

Medical Air Plant uAIR

Build up your Air Plant on-line

By using latest technology in medical sector we are able to build Air Plant precisely matching your demand. We give you freedom of choice to select any flow, local regulations and limitation. Moreover our on-line configurator will propose you best combination of elements according to medical standards like ISO7396 or HTM 02-01, HTM 2022.



www.atlascopco.com/medical or use already calculated variants:

Plant based on oil-free piston compressors (8 bar plant output pressure).

Name	Flow at 50Hz		Flow at 60Hz		Compressor		Dryer		Vessel	
	l/s	l/m	l/s	lpm	Type	Q-ty *	Type	Q-ty	Type	Q-ty
uAIR-LF	6,8	408			LF5-MED	3	MED7+	2	250	2
	13,0	782	13,4	804	LF7-MED	3	MED13+	2	250	2
	17,5	1050	19,5	1170	LF7-MED	4	MED25+	2	250	2
	25,5	1530	25,5	1530	LF10-MED	4	MED25+	2	250	2
	26,7	1602	30,1	1806	LF7-MED	5	MED35+	2	250	2
	35,7	2142	35,7	2142	LF10-MED	5	MED35+	2	250	2
	37,0	2220	45,2	2712	LF10-MED	5	MED50+	2	250	2
	50,5	3030	50,2	3012	LF10-MED	6	MED50+	2	250	2

Plant based on oil-free scroll compressors (8 bar plant output pressure).

uAIR-SF	1,87	112	1,92	115	SF2-MED	3	MED7+	2	250	2
	4,22	253	4,07	244	SF4-MED	3	MED7+	2	250	2
	6,67	400	6,67	400	SF6-MED	3	MED7+	2	250	2
	13,14	788	13,4	13	SF6-MED	4	MED13+	2	250	2
	19,5	1170	19,5	1170	SF6-MED	5	MED25+	2	250	2
	25,5	1530	25,5	1530	SF6-MED	6	MED25+	2	250	2

Plant based on oil-free tooth compressors (8 bar plant output pressure).

uAIR-ZF	25,4	1524	25,5	1530	ZT15-MED	3	MED25+	2	250	2
	30,9	1854	32,4	1944	ZT18-MED	3	MED35+	2	500	2
	35,7	2142	35,7	2142	ZT22-MED	3	MED35+	2	500	2
	50,3	3019	50,5	3031	ZT15-MED	4	MED50+	2	250	2
	61,8	3708	64,8	3888	ZT18-MED	4	MED70+	2	500	2
	71,4	4284	71,0	4260	ZT22-MED	4	MED70+	2	500	2
	81,6	4896	81,6	4896	ZT18-MED	5	MED80+	2	500	2
	92,6	5558	97,4	5844	ZT18-MED	5	MED100+	2	500	2
	121,0	7260	127,3	7638	ZT18-MED	6	MED145+	2	500	2
	146,5	8790	146,5	8790	ZT22-MED	6	MED145+	2	500	2

* According to ISO 7396-1 three sources of supply should be foreseen. For this reason there are two compressors and one dryer reserved as a backup.

Plant based on water injected compressors (4 / 8 / 11 bar plant output pressure)

Name	Plant output pressure, bar	Flow at 50Hz		Flow at 60Hz		Compressor		Dryer		Vessel	
		l/s	lpm	l/s	lpm	Type	Q-ty *	Type	Q-ty	Type	Q-ty
uAIR-AV	8	13,4	804	13,4	804	AQ15 VSD MED	3	MED13+	2	250	2
	8	25,5	1530	25,5	1530	AQ15 VSD MED	3	MED25+	2	500	2
	8	31,8	1908	31,8	1908	AQ15 VSD MED	3	MED35+	2	500	2
	8	44,7	2682	44,7	2682	AQ22 VSD MED	3	MED50+	2	500	2
	8	63,6	3816	63,6	3816	AQ15 VSD MED	4	MED70+	2	500	2
	8	81,6	4896	81,6	4896	AQ22 VSD MED	4	MED80+	2	500	2
	8	101,0	6060	101,0	6060	AQ18 VSD MED	5	MED100+	2	500	2
	8	135,1	8106	135,1	8106	AQ22 VSD MED	5	MED145+	2	500	2
	11	15,1	904	15,1	904	AQ15 VSD MED	3	MED13+	2	500	2
	11	24,9	1495	24,9	1495	AQ15 VSD MED	3	MED25+	2	500	2
	11	49,3	2957	49,3	2957	AQ15 VSD MED	4	MED50+	2	250	2
	11	74,0	4440	74,0	4440	AQ22 VSD MED	4	MED80+	2	500	2
	11	92,7	5562	92,7	5562	AQ18 VSD MED	5	MED80+	2	500	2
	11	146,0	8760	146,0	8760	AQ22 VSD MED	6	MED145+	2	500	2

Plant based on oil-lubricated screw compressors (4 / 8 / 11 bar output pressure)

uAIR-GF	4/8	7,1	426	7,6	456	GA5-10	1(+2)	MED7+	1(+1)	250	2
	4/8	13,4	804	13,1	786	GA7-10	1(+2)	MED13+	1(+1)	250	2
	4/8	21,5	1290	20,4	1224	GA11-10	1(+2)	MED25+	1(+1)	250	2
	4/8	30,0	1800	29,5	1770	GA15-10	1(+2)	MED35+	1(+1)	500	2
	4/8	35,7	2142	35,7	2142	GA18-10	1(+2)	MED35+	1(+1)	500	2
	4/8	42,2	2532	41,2	2472	GA22-10	1(+2)	MED50+	1(+1)	500	2
	4/8	50,5	3030	50,5	3030	GA15-10	2(+2)	MED50+	1(+1)	500	2
	4/8	60,0	3600	59,0	3540	GA15-10	2(+2)	MED70+	1(+1)	500	2
	4/8	81,6	4896	81,6	4896	GA22-10	2(+2)	MED80+	1(+1)	500	2
	4/8	146,5	8790	145,7	8742	GA18-10	4(+2)	MED145+	1(+1)	500	2
4/8	168,2	10092	168,1	10086	GA22-10	4(+2)	MED145+	1(+1)	500	2	

uAIR-GF	4/11	7,7	462	7,2	432	GA5-13	1(+2)	MED7+	1(+1)	250	2
	4/11	11,7	702	11,7	702	GA7-13	1(+2)	MED13+	1(+1)	250	2
	4/11	15,1	906	15,1	906	GA11-13	1(+2)	MED13+	1(+1)	250	2
	4/11	25,6	1536	24,8	1488	GA15-13	1(+2)	MED25+	1(+1)	250	2
	4/11	29,3	1758	29,3	1758	GA18-13	1(+2)	MED25+	1(+1)	500	2
	4/11	30,9	1854	31,5	1890	GA18-13	1(+2)	MED35+	1(+1)	500	2
	4/11	38,7	2322	40,3	2418	GA22-13	1(+2)	MED35+	1(+1)	500	2
	4/11	41,0	2460	41,0	2460	GA15-13	2(+2)	MED35+	1(+1)	250	2
	4/11	50,7	3042	49,1	2946	GA15-13	2(+2)	MED50+	1(+1)	250	2
	4/11	77,4	4644	80,6	4836	GA22-13	2(+2)	MED70+	1(+1)	500	2
	4/11	81,9	4914	81,9	4914	GA18-13	3(+2)	MED70+	1(+1)	500	2
	4/11	116,0	6960	116,0	6960	GA22-13	3(+2)	MED100+	1(+1)	500	2
4/11	152,4	9144	158,8	9528	GA22-13	4(+2)	MED145+	1(+1)	500	2	

* According to ISO 7396-1 three sources of supply should be foreseen. For this reason there are two compressors and one dryer reserved as a backup.

Oil-free piston compressors for medical applications

LF-MED

To safeguard your patient’s health and protect your valuable equipment you deserved clean, 100% oil-free compressed air.

Designed to be a part of a Medical Air Plant, Atlas Copco’s high performance LF-MED piston compressors provide you with 100% oil-free air. Atlas Copco’s LF-MED oil-free, aluminum piston air compressors stand for exceptional reliability and extremely low operating costs and are virtually maintenance-free. Furthermore, with their small and compact design, they offer maximum installation flexibility.

- **Low running costs** – Operational costs are limited over a long product lifetime.
- **Full compliance** – The Medical Air Plant uAIR series based on LF-MED compressors is pre-certified according to MDD 93/42/EEC which simplifies your installation and commissioning process. It is designed and manufactured according to ISO 9001, ISO 14001 and the ISO 13485:2003 quality management system and surpasses the requirements of the most demanding standards and regulations such as:
 - Medical Device Directive MDD 93/42/EEC
 - European Pharmacopoeia
 - EN ISO 7396-1
 - ISO 14971
 - Health Technical Memorandums HTM 02-01 and HTM 2022.

CUSTOMER BENEFITS

- **High reliability** – Thanks to a unique, robust design and the optimal combination of quality materials, LF compressors offer improved performance and extended product life.
- **High safety level** – Thanks to full remote monitor/control, automatic restart after voltage failure, Emergency Force Local, additional aftercooler, and outlet temperature monitor. All of these functions differentiate the LF-MED from standard industrial compressor and give you the full control and peace of mind required in medical applications;
- **Solid reliability** – Through durable engineering and through testing, the LF-MED is guaranteed to generate 50% more air and have a 50% longer operating life compared to similar products on the market;
- **Easy maintenance** – All components and service points are easily accessible.



Type	Pressure		FAD * at 1,500 rpm(50 Hz)			FAD * at 1,800 rpm (60 Hz)			Power		Noise level**
	bar	psi	l/s	l/m2	cfm	l/s2	l/m	cfm2	kW	HP	
LF 5-10 MED	10	145	8,2	492	17,4	9,1	546	19,3	4,0	5,5	68/70
LF 7-10 MED	10	145	11	660	23,3	12,0	720	25,4	5,5	7,5	72/74
LF 10-10 MED	10	145	15,5	930	32,8	18,2	1092	38,6	7,5	10	74/76

* Unit performance measured according to ISO 1217, Annex C, latest edition.

** Noise level measured at a distance of 1m according to Pneuop/Cagi PN8NTC2 test code.

Reference conditions:

- absolute inlet pressure 1 bar (14.5 psig)

- intake air temperature 20°C (68°F)

- FAD is measured at the following working pressure:: 10 bar versions at 9.75 bar.

Oil-free scroll compressors for medical applications

SF-MED

Atlas Copco's SF-MED range of oil-free compressors are especially designed to be a part of a Medical Air Plant. These ISO 8573-1 CLASS 0 certified compressors are easy to operate and maintain, and have a minimal footprint to save space in your facility. SF-MED compressors eliminate the risks of oil contamination while providing an efficient, reliable and highly cost-effective source of pure oil-free air.

CUSTOMER BENEFITS

- **Extremely quiet operation** – The slow speed of the scroll compression elements ensures that the SF scroll compressors are exceptionally quiet. SF units are WorkPlace Air System™ compressors, making them suitable for installation in any working environment.
- **Energy efficiency** – SF-MED scroll compressors are ideal for applications where flexibility and energy efficiency are crucial.
- **Low maintenance** – SF-MED scroll compressors stand for simplicity and reliability. The scroll design has a minimal number of moving parts, ensuring a long operating life with a minimum number of service interventions.
- **Advanced control and monitoring** – To maximize efficiency and reliability, the Elektronikon® MkV controls the main drive motor and regulates system. In combination with the ES-Medical Central Controller, your Medical Air Plant under full control and monitoring.

- **Full compliance** - The Medical Air Plant uAIR series based on SF-MED compressors is pre-certified according to MDD 93/42/EEC which simplifies your installation and commissioning process. It is designed and manufactured according to ISO 9001, ISO 14001 and the ISO 13485:2003 quality management system and surpasses the requirements of the most demanding standards and regulations such as:
 - Medical Device Directive MDD 93/42/EEC
 - European pharmacopoeia
 - EN ISO 7396-1
 - ISO 14971
 - Health Technical Memorandums HTM 02-01 and HTM 2022.



Type	Pressure		Capacity FAD *			Power		Noise level**
	bar	psi	l/m	l/m2	cfm	kW	HP	
SF 1 MED	10	145	2,1	126	4,4	1,5	2	53
SF 2 MED	10	145	3,4	204	7,2	2,2	3	55
SF 4 MED	10	145	5,6	336	11,9	3,7	5	57
SF 6 MED	10	145	8,8	528	18,6	5,9	8	63

* Unit performance measured according to ISO 1217, Annex C, latest edition.

** Noise level measured at a distance of 1m according to Pneurop/Cagi PN8NTC2 test code.

*** Maximum plant flow based on LF-MED compressors according to ISO7396-1 and HTM0201 incl. one backup compressor.

Reference conditions:

- absolute inlet pressure 1 bar (14.5 psig)

- intake air temperature 20°C (68°F)

- FAD is measured at the following working pressure:: 10 bar versions at 9.75 bar.

Oil-free tooth compressors for medical applications

ZT-MED

Atlas Copco's ZT-MED oil-free rotary tooth compressors meet your needs for pure oil-free air while offering wide pressure ranges and improved energy efficiency. Developed especially to be a part of a Medical Air Plant, they provide the highest levels of reliability and air purity. ZT-MED compressors eliminate the risks of oil contamination as well as the resulting extra costs. These ISO 8573-1 CLASS 0 certified compressors are easy to operate and maintain

CUSTOMER BENEFITS

- Certified 100% oil-free air** – ZT-MED compressors provide 100% pure, clean air that complies with ISO 8573-1 CLASS 0 (2010) certification. CLASS 0 means zero risk for patients; zero risk of contaminating hospital pipelines; zero risk of damaging connected equipment (e.g., anesthesia machines); and zero risk of damaging your hospital's hard-won professional reputation. In 2006, Atlas Copco was the first manufacturer in the world to receive such certification for an oil-free compressor.
- Quiet operation** – The vertical layout of the coolers reduces the noise levels from the fan, motor and element. Moreover, ZT-MED compressors are supplied in a sound-insulated canopy, thus avoiding the need for additional sound isolation.

- Advanced control and monitoring** – To maximize efficiency and reliability, the Elektronikon® MkV controls the main drive motor and regulates the system. In combination with the ES-Medical Central Controller, your Medical Air Plant is under full control and monitoring.
- Easy maintenance** – The robust air inlet filter offers a long lifetime and high reliability for long service intervals and low maintenance needs.
- Full compliance** - The Medical Air Plant uAIR series based on ZT-MED compressors is pre-certified according to MDD 93/42/EEC which simplifies your installation and commissioning process. It is designed and manufactured according to ISO 9001, ISO 14001 and the ISO 13485:2003 quality management system and surpasses the requirements of the most demanding standards and regulations such as:
 - Medical Device Directive MDD 93/42/EEC
 - European pharmacopoeia
 - EN ISO 7396-1
 - ISO 14971
 - Health Technical Memorandums HTM 02-01 and HTM 2022.



Type	Pressure		Capacity FAD			Power		Noise level**
	bar	psi	l/s	l/m	cfm	kW	HP	
ZT 15 MED	10	145	30.2	1812	64	15	20	65
ZT 18 MED	10	145	36.4	2184	77.1	18	25	67
ZT 22 MED	10	145	45.3	2718	96	22	30	69
ZT 22 VSD MED	10	145	19,7-47,0	1182-2820	41,9-100	22	30	69
ZT/ZR 30 MED *	8.6	125	73.7	4422	156	30	40	63
ZT/ZR 37 MED *	8.6	125	92.1	5526	195	37	50	65
ZT/ZR 45 MED *	8.6	125	108.9	6534	231	45	60	67
ZT/ZR 37 VSD MED *	8.6	125	41,2-97,3	2472-5838	87,6-206,9	37	50	68
ZT/ZR 55 VSD MED *	8.6	125	41,2-138,8	2472-8328	87,6-295,2	55	75	68

* only for ISO7396-1 air plant variant

** Unit performance measured according to ISO 1217, Ed 3, Annex C-1996

Reference conditions:

- absolute inlet pressure 1 bar (14.5 psi)

- intake air temperature 20°C (68°F)

- FAD is measured at the following working pressure:

8.6 bar versions at 8 bar.

10 bar versions at 9.75 bar.

*** Noise level measured according to Pneuop/Cagi PN8NTC2, tolerance: 3 dB(A).

For ZT air-cooled units: +3 dB(A)

Water-injected screw compressors for medical applications

AQ-MED

Atlas Copco's AQ-MED water-injected screw compressors, available in water-cooled and aircooled versions, as a part of Medical Air Plant meet your precise needs for pure, oil-free medical air while offering high-pressure capability and improved energy efficiency. Developed especially for medical applications demanding the highest levels of reliability and purity. They ensure consistent 100% oil-free air while you benefit from lower operating and maintenance costs with an ISO 8573-1 CLASS 0 (2010) certified compressor. Standard installed Variable Speed Drive assure additional energy savings.

CUSTOMER BENEFITS

- **High efficiency** – Thanks to the superior cooling capability of water which ensures that the heat is removed efficiently at the source, more air per kW of power is generated. Energy savings of 35% on average are possible with the standard included Variable Speed Drive.
- **Certified 100% oil-free air** – AQ-MED compressors provide 100% pure, clean air, complying with ISO 8573-1 CLASS 0 (2010) certification. CLASS 0 means zero risk for patients; zero risk of contamination hospital pipelines; zero risk of damage expensive equipment (e.g. anesthesia machines) and zero risk of damaging your hospital hard-won professional reputation. In 2006, Atlas Copco was the first manufacturer in the world to receive such certification for an oil-free compressor.

- **Advanced control and monitoring** – To maximize efficiency and reliability, the Elektronikon® MkV controls the main drive motor and regulates system. In combination with the ES-Medical Central Controller, your Medical Air Plant under full control and monitoring.
- **Quiet operation** – AQ-MED compressors are supplied in a soundinsulated canopy, thus avoiding needs for additional sound isolation.
- **Full compliance** – The Medical Air Plant uAIR series based on AQMED compressors is pre-certified according to MDD 93/42/EEC which simplifies your installation and commissioning process. It is designed and manufactured according to ISO 9001, ISO 14001 and the ISO 13485:2003 quality management system and surpasses the requirements of the most demanding standards and regulations such as:
 - Medical Device Directive MDD 93/42/EEC
 - European pharmacopoeia
 - EN ISO 7396-1
 - zISO 14971



Type	Pressure		Capacity FAD at 13 bar		Capacity FAD at 7 bar		Power		Noise level**
	bar	psi	l/s	cfm	l/s	cfm	kW	HP	
AQ 15 VSD MED	13	175	22 - 29	46 - 61	22-47	46-100	15	20	67
AQ 18 VSD MED	13	175	22 - 36	46 - 76	22-54	46-114	18	25	69
AQ 22 VSD MED	13	175	22 - 44	46 - 93	22-66	46-139	22	30	70
AQ 30 VSD MED	13	175	22 - 61	46 - 129	22-83	46-176	30	41	72

* Unit performance measured according to ISO1217 Annex C, latest edition.

Reference conditions:

- Absolute inlet pressure 1 bar (14.5 psi)
- Intake air temperature 20°C (68°F)

** Noise level measured at a distance of 1m according to Pneurop/Cagi PN8NTC2 test code: 3dB(l)

Screw compressors for medical applications

GA-MED

Designed precisely for medical applications, GA MED oil-injected compressors bring you proven reliability and Atlas Copco's latest high-efficiency compression element. You benefit from outstanding performance, flexible operation and the highest productivity, along with minimal total cost of ownership.

CUSTOMER BENEFITS

- **Highest reliability** – Three premium compressor series – GA 5-11 MED, GA 5-15 VSD MED and GA 15-22 MED are designed, manufactured and tested in accordance with ISO 9001, ISO 14001 and ISO 1217, Ed. 3, Annex C. Ensuring a long and trouble-free life at the lowest operating cost, each GA MED contains the latest generation of Atlas Copco's innovative oil-injected screw element.
- **Peace of mind** – All GA MED compressors are equipped with additional safety protections. Even in case of a single fault condition, the air demand is always assured.
- **VSD** – Driving down energy costs. Energy typically represents over 80% of a compressor's life cycle cost. Looking continuously to innovate and reduce customer costs, Atlas Copco pioneered Variable Speed Drive (VSD) technology in 1994. The GA 5-11 VSD MED range is the ideal solution for a fluctuating air demand. By monitoring the outlet pressure, the air Capacity FAD is adjusted to the demand. Energy savings of 35% on average become a reality thanks to the high turndown ratio and the new fan saver cycle.
- **Air system integration** – The GA MED can be placed where you need it. Its low noise operation and dedicated air treatment equipment ensure a healthier environment in the plant room. Moreover, all GA MED compressors are delivered ready for use, significantly reducing installation costs.
- **Advanced control and monitoring** – To maximize efficiency and reliability, the Elektronikon® controls the main drive motor and regulates system pressure within a predefined and narrow pressure band. The Elektronikon® controller can be adapted to your specific needs with extra sensors, digital contacts, fieldbus, Internet and SMS communication functions. In combination with the ES multiple compressor controller, the operation of your complete compressor room is optimized.
- **Integrated purity** – When partnered with a dedicated MED+ or MED air purifying system, the GA MED generates compressed air into pure breathing quality air. You rest assured at all times that the air quality delivered by the system accords to what the doctor ordered.



GA 5-22 MED

Type	Max.working pressure		Capacity FAD*			Installed motor power		Noise level	Weight	Length	Width	Height	
	bar(e)	psig	l/s	m³/h	cfm	kW	hp	dB(A)	kg	mm	mm	mm	
50 Hz													
GA 5 MED	7.5	7.5	109	15.0	54.0	31.8	5.5	7.5	60	257	1142	699	1240
	10	10	145	11.7	42.1	24.8	5.5	7.5	60	257	1142	699	1240
	13	13	189	8.4	30.2	17.7	5.5	7.5	60	257	1142	699	1240
GA 7 MED	7.5	7.5	109	21.8	78.5	46.2	7.5	10	61	270	1142	699	1240
	10	10	145	17.2	61.9	36.4	7.5	10	61	270	1142	699	1240
	13	13	189	14.2	51.1	30.1	7.5	10	61	270	1142	699	1240
GA 11 MED	7.5	7.5	109	30.7	110.5	65.0	11	15	62	293	1142	699	1240
	10	10	145	26.0	93.6	55.1	11	15	62	293	1142	699	1240
	13	13	189	22.0	79.2	46.6	11	15	62	293	1142	699	1240
GA 15 MED	7.5	7.5	109	43.0	154.8	91.1	15	20	72	375	1285	680	932
	10	10	145	36.3	130.7	76.9	15	20	72	375	1285	680	932
	13	13	189	30.1	108.4	63.8	15	20	72	375	1285	680	932
GA 18 MED	7.5	7.5	109	52.5	189.0	111.2	18.5	25	73	395	1285	680	932
	10	10	145	44.0	156.6	92.2	18.5	25	73	395	1285	680	932
	13	13	189	37.2	133.9	78.8	18.5	25	73	395	1285	680	932
GA 22 MED	7.5	7.5	109	60.2	216.7	127.6	22	30	74	410	1285	680	932
	10	10	145	51.7	186.1	109.5	22	30	74	410	1285	680	932
	13	13	189	45.0	162.0	95.3	22	30	74	410	1285	680	932
60 Hz													
GA 5 MED	100	7.4	107	15.0	54.0	31.8	5.5	7.5	60	257	1142	699	1240
	150	10.8	157	11.7	42.1	24.8	5.5	7.5	60	257	1142	699	1240
	175	12.5	181	8.5	30.6	18.0	5.5	7.5	60	257	1142	699	1240
GA 7 MED	100	7.4	107	21.0	75.6	44.5	7.5	10	61	270	1142	699	1240
	150	10.8	157	17.2	61.9	36.4	7.5	10	61	270	1142	699	1240
	175	12.5	181	14.2	51.1	30.1	7.5	10	61	270	1142	699	1240
GA 11 MED	100	7.4	107	30.4	109.4	64.4	11	15	62	293	1142	699	1240
	150	10.8	157	24.9	89.6	52.8	11	15	62	293	1142	699	1240
	175	12.5	181	22.0	79.2	46.6	11	15	62	293	1142	699	1240
GA 15 MED	100	7.4	107	42.5	153.0	90.1	15	20	72	375	1285	680	932
	150	10.8	157	35.8	128.9	75.9	15	20	72	375	1285	680	932
	175	12.5	181	29.3	105.5	62.1	15	20	72	375	1285	680	932
GA 18 MED	100	7.4	107	51.3	184.7	108.7	18.5	25	73	395	1285	680	932
	150	10.8	157	43.3	155.9	91.7	18.5	25	73	395	1285	680	932
	175	12.5	181	37.8	136.1	80.1	18.5	25	73	395	1285	680	932
GA 22 MED	100	7.4	107	60.6	218.2	128.4	22	30	74	410	1285	680	932
	150	10.8	157	50.7	182.5	107.4	22	30	74	410	1285	680	932

GA 5-22 MED VSD

Type	Max.working pressure		Capacity FAD*			Installed motor power		Noise level	Weight	Length	Width	Height
	bar(e)	psig	l/s	m³/h	cfm	kW	hp	dB(A)	kg	mm	mm	mm
50 / 60 Hz												
GA 5 VSD MED	7.5	109	5.7-15.0	20.5-54.0	12.1-31.8	5.5	7.5	62	278	1395	699	1240
	10	145	7.1-13.2	25.6-47.5	15.0-28.0	5.5	7.5	62	278	1395	699	1240
	13	188	8.9-10.0	32.0-36.0	18.9-21.2	5.5	7.5	62	278	1395	699	1240
GA 7 VSD MED	7.5	109	4.9-20.3	14.4-73.0	10.4-43.0	7.5	10	64	280	1395	699	1240
	10	145	7.2-16.8	25.9-60.5	15.3-35.6	7.5	10	64	280	1395	699	1240
	13	188	5.1-13.8	23.0-49.7	10.8-29.2	7.5	10	64	280	1395	699	1240
GA 11 VSD MED	7.5	109	6.5-30.7	23.4-110.5	13.8-65.0	11	15	66	293	1395	699	1240
	10	145	8.7-24.1	31.3-86.8	18.4-51.1	11	15	66	293	1395	699	1240
	13	188	7.9-20.7	28.4-74.5	16.7-43.9	11	15	66	293	1395	699	1240
GA 15 VSD MED	7.5	109	9.1-37.1	32.8-133.6	19.3-78.6	7.5	10	69	300	1395	699	1240
	10	145	8.8-30.9	31.7-111.2	18.6-65.5	7.5	10	69	300	1395	699	1240
	13	188	8.5-24.8	30.6-89.3	18.0-52.5	7.5	10	69	300	1395	699	1240

* Unit performance measured according to ISO 1217, Ed. 4, 2009, Annex C-E.

** Mean noise level measured at a distance of 1 m according to ISO 2151; tolerance 3 dB(A).

Reference conditions:

- Absolute Inlet pressure, specify bar(a), (e) 1 bar (14.5 psi)
- Intake air temperature 20°C, 68°F FAD is measured at the following working pressures:
- 7.5 bar versions at 7 bar(e)
- 10 bar versions at 9.5 bar(e)
- 13 bar versions at 12.5 bar(e) Maximum working pressure for VSD machines:
- 13 bar(e) (188 psig)

Medical Air Purifiers

MED / MED⁺

The critical field of patient care requires ultra-clean, purified, medical air delivered to operating theaters and hospital beds with absolute reliability. The Atlas Copco MED/MED⁺ series of Medical Air Purifiers offers unique multi-stage filtration that converts regular compressed air from any type of compressor into internationally certified medical air. These innovative devices provide clean air for all your medical and surgical applications.

CUSTOMER BENEFITS

- **Assured reliability** – Built to the most exacting standards, the MED/MED⁺ series is engineered to provide certified medical air even in areas with high ambient pollution. These air purifiers ensure high air quality in ‘worst case’ but real-life pollution scenarios. With the assurance of Atlas Copco’s excellent worldwide after-sales service, the MED series offers the complete solution for critical air environments.
- **Medically certified** – The medical sector is more tightly regulated than ever before. Atlas Copco’s MED/MED⁺ air purifiers are pre-certified to international regulations including Pharmacopoeia and quality norms such as ISO 13485. Pre-certification simplifies organization and inspection by regulatory bodies, saving the hospital time and money and reducing the risk of a rework of the system to satisfy requirements. MED/MED⁺ air purifiers surpass the requirements of the most demanding standards and regulations such as:
 - Medical Device Directive MDD 93/42/EEC.
 - EN ISO 7396-1.
 - ISO 14971.
 - Health Technical Memorandums HTM 02-01 and HTM 2022.
- Furthermore, they are designed and manufactured according to ISO 9001, ISO 14001 and the ISO 13485:2003 quality management system.
- **Energy-efficient** – The MED⁺ incorporates state-of-the-art energy management control with built-in purge control as standard (optionally available on the MED series). This purge control makes

the purifiers more efficient, leading to energy savings of up to 90%, depending on installation and usage. The principle is simple. Although the regeneration time remains constant, the delay before switching from one tower to the other is controlled via the PDP sensor. As soon as the target PDP is reached, the dryer cycle that was on hold will resume by switching to the dry tower.

- **Assured purity** – MED/MED⁺ air purifiers provide the ultra clean air you require. Their innovative filtration system is the definitive medical air solution, while a small footprint allows you to make the most of the space available. The MED/MED⁺ offers unparalleled air purity through 7 stages of active purification.
- Seven steps to quality medical air:
 - A water separator to remove liquid water
 - A bulk aerosol filter eliminates oil and water
 - A fine coalescing filter removes even smaller particles of oil and water
 - A desiccant dryer takes out any remaining water and CO₂
 - Activated carbon removes gaseous impurities
 - A catalyst takes care of a CO oxidation
 - A bacteria filter eliminates bacteria and fine particles. This bacteria filter is an Atlas Copco PDP filter, which has been externally tested and certified as a bacterial filter.



MED/ MED+

Type	Inlet pressure, specify bar(a), (e)		Capacity FAD			Puge %	Pressure drop	
	bar(e)	psig	l/s	m³/h	cfm		dP, mbar	psi
MED / MED+								
MED7 / MED7+	7	102	7.0	25.2	14.8	19.0	510	7.4
	10	145	8.4	30.2	17.8	15.8	510	7.4
	13	188	9.4	33.8	19.9	14.1	510	7.4
MED13 / MED13+	7	102	13.0	46.8	27.5	19.0	530	7.7
	10	145	15.6	56.2	33.1	15.8	530	7.7
	13	188	17.5	63.0	37.1	14.1	530	7.7
MED25 / MED25+	7	102	25.0	90.0	53.0	18.0	560	8.1
	10	145	30.0	108.0	63.6	15.0	560	8.1
	13	188	33.8	121.7	71.6	13.3	560	8.1
MED35 / MED35+	7	102	35.0	126.0	74.2	18.0	600	8.7
	10	145	42.0	151.2	89.0	15.0	600	8.7
	13	188	47.3	170.3	100.2	13.3	600	8.7
MED50 / MED50+	7	102	50.0	180.0	106.0	19.0	820	11.9
	10	145	60.0	216.0	127.1	15.8	820	11.9
	13	188	67.5	243.0	143.0	14.1	820	11.9
MED70 / MED70+	7	102	70.0	252.0	148.3	18.0	660	9.6
	10	145	84.0	302.4	178.0	15.0	660	9.6
	13	188	94.5	340.2	200.2	13.3	660	9.6
MED80 / MED80+	7	102	80.0	288.0	169.5	18.0	700	10.2
	10	145	96.0	345.6	203.4	15.0	700	10.2
	13	188	108.0	388.8	228.9	13.3	700	10.2
MED100 / MED100+	7	102	100.0	360.0	211.9	19.0	820	11.9
	10	145	120.0	432.0	254.3	15.8	820	11.9
	13	188	135.0	486.0	286.1	14.1	820	11.9
MED145 / MED145+	7	102	145.0	522.0	307.3	19.0	800	11.6
	10	145	174.0	626.4	368.7	15.8	800	11.6
	13	188	195.8	704.9	414.9	14.1	800	11.6

Type	MED					MED+				
	Weight, kg	Length, mm	Width, mm	Height, mm	NTP connection	Weight, kg	Length, mm	Width, mm	Height, mm	NTP connection
MED7 / MED7+	184	950	650	885	1/2"	214	950	650	1851	1/2"
MED13 / MED13+	201	950	650	1075	1/2"	231	950	650	1851	1/2"
MED25 / MED25+	245	950	650	1300	1/2"	275	950	650	1851	1/2"
MED35 / MED35+	271	950	650	1545	1/2"	301	950	650	1851	1/2"
MED50 / MED50+	315	950	650	1915	1"	345	950	650	1858	1"
MED70 / MED70+	446	1250	850	1545	1"	476	1250	850	1840	1"
MED80 / MED80+	494	1250	850	1915	1 1/2"	524	1250	850	1840	1"
MED100 / MED100+	502	1250	850	1915	1 1/2"	532	1250	850	1840	1"
MED145 / MED145+	620	1250	850	1915	1 1/2"	650	1250	850	1856	1"

Additional options

Description	MED	MED+
EWD on filters and water drain	○	○
Inlet solenoid for remote control	-	○
NPT connection	○	○
QDT quality indicator	○	○
Catalyst(CO to CO ₂)	○	○
CO sensor	○	○
CO ₂ sensor	○	○
O ₂ sensor	○	-
Overflow protection(nozzle)	○	○
AirContact and Combox-e with visualisation	-	○
Gateway(Profibus, Modbus)	-	○

- : Not applicable ○: Optional

Medical Vacuum Plant

mVAC

Atlas Copco's mVAC Medical Vacuum Systems consist of 2 to 6 air-cooled, oil-lubricated rotary vane type vacuum pumps and a central controller with an intelligent graphical user interface. They provide a highly reliable medical vacuum (suction) for a variety of applications, mainly in operating theaters and intensive care, emergency and respiratory units. The mVAC system offers (multiple) backup supply in case of failure of individual functional components.

CUSTOMER BENEFITS

- **Solid reliability** – The carbon composite material of our mVAC pumps will not break down or wear out like laminated blades. Even if the central controller should fail, every pump still has its own controller.
- **Highly connectable** – Up to six vacuum pumps can be connected in one mVAC system to ensure

that even a large hospital always has a reliable vacuum to meet all its needs. Furthermore, using AIRConnect™ Visualization you can connect to extensive monitoring and status information to get the most out of your mVAC system.

- **Energy-efficient** – The mVAC incorporates a multi-pump arrangement to better match the Capacity FAD demand. In this arrangement, the advanced Elektronikon® Graphic controller maximizes energy efficiency by controlling the individual vacuum pumps and regulating the overall vacuum. Uniform wear is ensured at all times.
- **Cost-effective** – Our unique Elektronikon® control system gives you the means to effectively manage and optimize your mVAC system. Device status is monitored in real time, required services are delivered rapidly, breakdowns can be prevented and downtime shortened. In short, it provides all you need to keep operational costs to a minimum.
- **Easy installation** – All interconnection piping and copper connections are supplied as an integral part of the mVAC system. This 'plug and play' approach makes installation even easier.



mVAC 250-8000

HTM 2022 - 50 Hz								
Type	System FAA @ -600 mbar(e) referred to 0 bar(e), 20°C	Capacity FAD	Number of pumps	Pump power	Dimensions* (filters included)	Weight (filters included)	Num- ber of vessels	Total vessel capacity
	l/min	m ³ /h		kW	LxWxH (mm)	kg		l
mVAC-250-DH	250	40	2	1.1	2040x980x1650	540	1	500
mVAC-500-TH	500	79	3	1.1	2300x980x1650	650	1	500
mVAC-660-TH	660	105	3	1.5	2400x980x1900	800	1	1000
mVAC-1000-TH	1000	159	3	2.2	2400x980x1900	860	1	1000
mVAC-1500-Q	1500	238	4	2.2	1830x980x1700	750	1	1500
mVAC-2560-T	2560	406	3	5.5	2600x1200x1600	1365	2	3000
mVAC-3840-Q	3840	609	4	5.5	2600x1200x1990	1700	2	4000
mVAC-4950-Q	4950	786	4	7.5	3400x1250x1700	1800	3	6000
mVAC-6000-P	6000	952	5	7.5	4100x1250x1700	2050	3	6000
mVAC-6600-P	6600	1047	5	7.5	4100x1250x1700	2050	4	8000
mVAC-8000-H	8000	1270	6	7.5	4100x1250x1990	2360	4	8000

mVAC 300-9200

HTM 2022 - 60 Hz								
Type	System FAA @ -600 mbar(e) referred to 0 bar(e), 20°C	Capacity FAD	Number of pumps	Pump power	Dimensions* (filters included)	Weight (filters included)	Num- ber of vessels	Total vessel capacity
	l/min	m ³ /h		kW	LxWxH (mm)	kg		l
mVAC-300-DH	300	48	2	1.5	2040x980x1650	540	1	500
mVAC-500-TH	500	79	3	1.5	2300x980x1650	650	1	500
mVAC-800-TH	800	127	3	2.2	2400x980x1900	800	1	1000
mVAC-1200-T	1200	190	3	3.0	1910x980x1700	610	1	1500
mVAC-1860-Q	1860	295	4	3.0	2200x1200x1700	1050	1	2000
mVAC-3000-T	3000	476	3	7.5	2600x1200x1600	1365	2	3000
mVAC-4500-Q	4500	714	4	7.5	3400x1250x1990	1825	3	4500
mVAC-5850-Q	5850	928	4	9.2	3400x1250x1990	1800	3	6000
mVAC-7800-P	7800	1238	5	9.2	4100x1250x1990	2160	4	8000
mVAC-9200-H	9200	1460	6	9.2	4100x1250x1990	2360	5	10000

* When available, horizontal vessels are included.

** Packaging included, vertical vessels excluded.

Additional options

AirConnect™ Visualization and Notification package
Customized software setting for different norms (HTM / ISO / AS)
Oil level switch
Synthetic oil
Painted vessels

mVAC 250-6600

HTM 02-01 / ISO 7396-150 Hz								
Type	System FAA @ -600 mbar(e) referred to 0 bar(e), 20°C	Capacity FAD	Number of pumps	Pump power	Dimensions* (filters included)	Weight (filters included)	Number of vessels	Total vessel capacity
	l/min	m³/h		kW	LxWxH (mm)	kg		l
mVAC-250-TH	250	40	3	1.1	2300x980x1650	650	1	500
mVAC-330-TH	330	52	3	1.5	2300x980x1650	690	1	500
mVAC-500-TH	500	79	3	2.2	2400x980x1650	750	1	500
mVAC-660-Q	660	105	4	1.5	1910x980x1430	660	2	1000
mVAC-1000-Q	1000	159	4	2.2	1910x980x1700	740	2	1000
mVAC-1280-T	1280	203	3	5.5	2200x1100x1450	1025	3	1500
mVAC-2560-Q	2560	406	4	5.5	2600x1200x1700	1625	2	3000
mVAC-3300-Q	3300	524	4	7.5	2600x1200x1700	1625	2	4000
mVAC-3840-P	3840	609	5	5.5	3300x1200x1990	1950	2	4000
mVAC-4950-P	4950	786	5	7.5	4100x1250x1700	2050	3	6000
mVAC-6000-H	6000	952	6	7.5	4100x1250x1700	2250	3	6000
mVAC-6600-H	6600	1047	6	7.5	4100x1250x1700	2250	4	8000

mVAC 300-7800

HTM 02-01 / ISO 7396-160 Hz								
Type	System FAA @ -600 mbar(e) referred to 0 bar(e), 20°C	Capacity FAD	Number of pumps	Pump power	Dimensions* (filters included)	Weight (filters included)	Number of vessels	Total vessel capacity
	l/min	m³/h		kW	LxWxH (mm)	kg		l
mVAC-300-TH	300	48	3	1.5	2300x980x1650	650	1	500
mVAC-400-TH	400	63	3	2.2	2300x980x1650	690	1	500
mVAC-620-T	620	98	3	3.0	1910x980x1430	750	2	1000
mVAC-800-Q	800	127	4	2.2	1910x980x1700	660	2	1000
mVAC-1200-Q	1200	190	4	3	1910x980x1430	740	2	2000
mVAC-1500-T	1500	238	3	7.5	2200x1100x1450	1025	2	2000
mVAC-3000-Q	3000	476	4	7.5	2600x1200x1700	1640	2	3000
mVAC-3900-Q	3900	619	4	9.2	2600x1200x1990	1700	2	4000
mVAC-4500-P	4500	714	5	7.5	4100x1250x1990	2075	3	4500
mVAC-5850-P	5850	928	5	9.2	4100x1250x1700	2050	3	6000
mVAC-7800-H	7800	1238	6	9.2	4100x1250x1990	2360	4	8000

* When available, horizontal vessels are included.

** Packaging included, vertical vessels excluded.



mVAC-500-TH



mVAC-1280-T



mVAC-6000-H

Custom solutions from Atlas Copco used all over the world

Compressors for railway, marine and ski slope applications

Atlas Copco compressors have an almost infinite number of potential applications. As well as being used in trade and industry, compressors from Atlas Copco are ideal for use on trains, trams, subways and ships, or can be employed as reliable and economical air compressors for snowmaking. Such applications call for compressors with a special degree of versatility and expertise.

...on railways

Designed for the toughest environments: On locomotives, railcars and trams, they can brake, open and close doors and raise and lower the pantographs. They are totally reliable, even under the toughest conditions, and are specially designed and built to match customer requirements.

- GAR screw compressors with up to 37 kW rated motor power
- SFR scroll compressors with up to 6.1 kW rated motor power
- LFXR piston compressors with up to 1.5 kW rated motor power
- LFR/LTR/LGR - oil-lubricated and oil-free piston compressors with up to 9.4 kW rated motor power



Download a QR Reader and scan the code for more information on our railway offerings.

<http://www.atlascopco.com/railway>



... at sea

They are ideal for use as ships' starting air compressors and are available with many different certifications. From 2.2 to 315 kW rated motor power, with 30 bar working pressure and volume flows of 2 to 781 l/s. Atlas Copco also offers the right compressors for use in working air applications on ships.

- MAS GA screw compressors with up to 315 kW rated motor power
- LT piston compressors with up to 15 kW rated motor power
- SF - Scroll compressors (up to 15kW)
- ZT - Oil-free tooth compressors (up to 45 kW)
- Nitrogen Generators



Download a QR Reader and scan the code for more information on our marine offerings.

<http://www.atlascopco.com/marine>

... on ski slopes

Set up as decentralized compressors, they supply compressed air for snow cannons, which turn water into snow. The compressors help create the right conditions on the slope and, naturally, are also oil-free.

- LFx Snow oil-free piston compressors with up to 7.5 kW rated motor power



AIR AND GAS TREATMENT

A treated compressed air system is essential to maintain the reliability of production processes and the quality of end products. Untreated air can cause corrosion in your compressed air piping network, premature failure of pneumatic equipment, harm to your production process, and product spoilage. Atlas Copco offers a full range of air and gas dryers , filters that will protect your systems and processes.

Compressed air treatment

Do you already know which compressor you want, but you're just missing the appropriate processing systems? A dryer for example? On the following pages you'll find a wide selection to suit every requirement, adapted to our compressors, to make your whole system more efficient. This is particularly sensible if the refrigerant or desiccant dryer is directly integrated in the compressor casing. This saves your installation time and floor space, in addition to significant energy savings due to lower pressure drops.

Intake air from the compressor always contains moisture. With the compression and subsequent cooling, the compressed air is always saturated to 100% with moisture. Anyone who sends compressed air through a pipe network needs to protect against corrosion in order to prevent machine failures or production waste.

As a result, each compressed air system includes at least one dryer and/or other processing components, such as filters or condensate separators. Different drying technologies are available: refrigerant dryers for simple applications and desiccant dryers for high to extremely high standards.

Refrigerant dryers are very reliable and economical. They work with built-in refrigerant compressors, which cool the air via heat exchangers, separate the resulting condensate and produce dry air with a pressure dewpoint of 3°C, so your systems are reliably protected from corrosion.

For industries, in which – for example – products have to be supplied or dried with compressed air, desiccant dryers are recommended and may even be indispensable. The air is not just cooled, the moisture is actively withdrawn via a desiccant, the so-called adsorption material. As soon as the desiccant is saturated, no more moisture can be withdrawn and it must be regenerated.

In order to guarantee a continuous air supply, rather than interrupting your manufacturing processes, desiccant dryers work with two containers or at least one container, which is separated into two sections. The air is dried in one, and the desiccant is regenerated in the other. Desiccant dryers are available with pressure dewpoints of –20°C, –40°C and even –70°C. This means the residual moisture of the processed air only condenses below the specified temperatures, such as, for example, below –70°C. This type of dry air is required in the production of electronic components, such as computer hard drives, etc.

Obviously, these applications have a higher energy requirement than simple applications, and, just like compressors, this also applies to dryers: The biggest cost factor in the lifecycle is power, not the initial investment. But whatever your requirements, and whether you choose a refrigerant or desiccant dryer, we can assure you that all of our compressed air processing systems are so well designed and so efficient, that your utility bills will be less of an issue in the coming years.

DRYING PROCESS

Water is a problem for your compressed air system. It can corrode and freeze compressed air pipes and tools, disturb your production process, and contaminate products. Thus, it can significantly increase maintenance costs and reduce productivity.

The drying process is the only way to remove almost all the moisture from the compressed air.



Refrigerant air dryers,
7 - 1166 l/s,
14 - 2374 cfm
FX

Page 120



**Blower purge desiccant
air dryers, 100-3000 l/s,
212-6360 cfm
BD+**

Page 132



Refrigerant air dryers,
6-4000 l/s,
13-8480 cfm
FD

Page 122



**Heat of compression
rotary drum dryers,
88-2500 l/s, 185-5297 cfm
MD**

Page 134



**Heatless desiccant
air dryers,
32-1600 l/s, 68-3392 cfm
CD**

Page 127



**Heat of compression
rotary drum dryers,
88-2500 l/s,
185-5297 cfm
ND**

Page 136



**Heatless desiccant
air dryers, 1-1400 l/s,
2-2968 cfm
CD+**

Page 128



**Heat-of-compression
desiccant air dryers,
1400-7000 l/s,
2970-14840 cfm
XD+**

Page 138



**Blower purge desiccant
air dryers, 360-1600 l/s,
763-3392 cfm
BD**

Page 130



**Membrane dryers
SD**

Page 140



**Purification units for
breathable air**
BAP / BAP+

Page 142



DD+, DDp+, PD+, PDp+, QD+
filters
(Standard and high pressure)
Compressed air filters

Page 145



**WSD 25-750 / WD 80 /
EWD 50-1500**
Water separators and drains

Page 148



Activated carbon tower,
20-310 l/s, 42-657 cfm
QDT

Page 150



**Oil/water separator
systems for the
condensate treatment**
OSC and OSD

Page 152

Refrigerant air dryers, 7-1166 l/s, 14-2374 cfm FX

Dry, quality air is vital for long-term, troublefree operation of your processes. Atlas Copco's FX dryers protect your products and systems against corrosion damage; by removing moisture from compressed air with a dew point as low as 3°C/37,4°F. Easy to install, simple to operate and reliable, they provide the dry air you need, allowing you to concentrate on your core business.

CUSTOMER BENEFITS

- **Reliability** – FX dryers offer a steady pressure dew point down to 3°F/37,4°F, with no freezing of condensed moisture, and no chance of moisture entering the compressed air system. They are constructed from generously sized, quality components. A simple and proven design is backed up by an effective control system (hot gas bypass) to ensure reliable performance.
- **Reduced energy costs** – Designed to ensure a low pressure drop, the FX dryer gives you dry air at low cost.
- **Easy installation** – Thanks to a plug and play concept, installation of your FX dryer could not be easier. You only need a single electrical connection. All units are pre-commissioned and self-regulating.
- **Low maintenance** – Long service intervals, few component replacements and an ergonomic design for fast access to key components combine to reduce the need for maintenance to an absolute minimum.



EFFICIENCY



Substantial cost savings

- Increased reliability and service life of tools and machines.
- Fewer leaks in the piping, resulting in lower energy consumption.
- Fewer repairs to tools, machines and piping.
- Few inconvenient machine breakdowns and interruptions.



FX 8

FX 1–21

Type	Maximum working pressure	Capacity FAD ⁽¹⁾		Pressure loss	Pressure dewpoint	Power consumption	Refrigerant	Inlet/outlet connections	Approx. weight	Dimensions L x W x H
	bar	l/s	m ³ /min	mbar	approx. °C	kW			kg	mm
FX – Refrigerant dryer air-cooled										
FX 1	16	6	0.36	150	3	0.13	R 134 a	G 3/4"	19	350 x 500 x 484
FX 2	16	10	0.60	250	3	0.16	R 134 a	G 3/4"	19	350 x 500 x 484
FX 3	16	14	0.84	250	3	0.19	R 134 a	G 3/4"	20	350 x 500 x 484
FX 4	16	20	1.20	250	3	0.27	R 134 a	G 3/4"	25	350 x 500 x 484
FX 5	16	30	1.80	300	3	0.28	R 134 a	G 3/4"	27	350 x 500 x 484
FX 6	16	39	2.34	320	3	0.61	R 404 a	G 1"	51	370 x 500 x 804
FX 7	13	50	3.00	320	3	0.67	R 404 a	G 1"	51	370 x 500 x 804
FX 8	13	60	3.60	180	3	0.79	R 404 a	G 1 1/2"	61	460 x 560 x 829
FX 9	13	68	4.08	250	3	0.87	R 404 a	G 1 1/2"	68	460 x 560 x 829
FX 10	13	87	5.22	180	3	1.07	R 404 a	G 1 1/2"	73	460 x 560 x 829
FX 11	13	108	6.48	200	3	1.19	R 404 a	G 1 1/2"	90	580 x 560 x 939
FX 12	13	128	7.68	270	3	1.45	R 404 a	G 1 1/2"	90	580 x 560 x 939
FX 13	13	167	10.02	250	3	1.80	R 410 a	G 2"	128	735 x 898 x 1002
FX 14	13	200	12.00	300	3	2.10	R 410 a	G 2"	146	735 x 898 x 1002
FX 15	13	250	15.00	300	3	2.65	R 410 a	G 2"	158	735 x 898 x 1002
FX 16	13	300	18.00	300	3	3.50	R 410 a	G 2"	185	735 x 898 x 1002
FX 17	13	400	24.00	250	3	4.70	R404 a	G 3"	325	1020 x 1023 x 1560
FX 18	13	500	30.00	300	3	5.30	R404 a	G 3"	335	1020 x 1023 x 1560
FX 19	13	583	34.98	350	3	6.40	R404 a	G 3"	350	1020 x 1023 x 1560
FX 19.5	13	750	45	250	3	6.7	R404 a	DN 125	380	1123 x 1020 x 1560
FX 20	13	833	49.98	300	3	8.40	R404 a	DN 125	550	1020 x 2099 x 1560
FX 21	13	1166	69.96	250	3	11.80	R404 a	DN 125	600	1020 x 2099 x 1560

⁽¹⁾ Capacity FAD based on 20°C, 1 bar. Reference conditions: working pressure 7 bar, compressed air temperature 35°C, ambient temperature 25°C, relative humidity on entry 100%, pressure dewpoint 3°C.

Refrigerant air dryers, 6-4000 l/s, 13-8480 cfm

FD

The compressed air you use must be clean and dry. Moisture can cause corrosion in pipe work, premature failure of pneumatic equipment, or product spoilage. Based on direct expansion technology with cycling, non-cycling and Variable Speed variants, Atlas Copco's FD dryers remove moisture from compressed air with a dewpoint as low as +3°C/+37.4°F. They are highly energy-efficient, easy to install, and among the most environmentally friendly and quietest in their class. Most importantly, they deliver dry air to protect your air system and finished products.

CUSTOMER BENEFITS

- **High reliability** – Atlas Copco's FD refrigerant dryers eliminate system failures, production downtime and costly repairs by removing moisture from compressed air with a pressure dewpoint as low as +3°C/+37.4°F. Separate components undergo severe endurance tests while the unique design of the heat exchanger significantly improves dryer lifetime. Advanced control functions ensure dry air at all conditions and prevent freezing at low loads.
- **Maximum energy savings** – Atlas Copco's refrigerant dryers incorporate energy-saving features that cut your carbon footprint. Incorporating unique heat exchanger technology and Saver Cycle Control, the FD ensures a low pressure drop of typically below 0.2 bar/2.9 psi and minimal energy consumption. Integrated Variable Speed Drive (VSD) technology variants offer even further energy savings by automatically tuning the energy input to the precise demand. The FD offers an extremely low total cost of ownership.
- **Easy installation** – FD dryers have a small footprint thanks to an innovative all-in-one design. Delivered ready for use, installation is straightforward, minimizing costly production downtime. On some models, in- and outlet connections are positioned on top of the unit, enabling installation against a wall.
- **Environmentally friendly** – Enclosed in a sound suppression canopy to reduce noise levels, FD dryers stand out by being among the most environmentally friendly and quietest in their class. They fully comply with ISO 14001 standards and Montreal Protocol regulations, and use CFC-free refrigerants to prevent any damage to the earth's ozone layer. FD dryers have an ozone depletion potential of zero.



Reducing energy costs

The refrigerant dryers from Atlas Copco have different integrated energy-saving functions, which improve the CO₂ balance and reduce costs. Thanks to a unique heat exchange technology and saver-cycle control, the FD series provides a lower pressure drop of an average of under 0.2 bar at minimal energy requirement. The speed regulation (VSD, Variable Speed Drive) allows additional energy savings because the energy consumption is automatically tailored to the requirements. This results in low costs over the entire service life.



FD 185



FD 5-2000



FD 120-285



FD 95

Saver-Cycle control

To save energy, FD dryers from Atlas Copco adapt their working cycle to the actual load, so the ambient temperature and the pressure dewpoint are constantly monitored and compared. With lower heat input, the refrigerant compressor stops, significantly reducing the power consumption.

Type	Maximum working pressure	Capacity FAD ⁽¹⁾		Pressure loss	Pressure dewpoint	Power consumption	Refrigerant	Inlet/ outlet connections	Approx. weight	Dimensions
	bar	l/s	m ³ /min	mbar	approx.°C	kW				L x W x H
FD – Refrigerant dryer, air-cooled										
FD 5	16	6	0.36	70	3	0.20	R 134 a	G 3/4"	27	496 x 377 x 461
FD 10	16	10	0.60	110	3	0.20	R 134 a	G 3/4"	27	496 x 377 x 461
FD 15	16	15	0.90	120	3	0.33	R 134 a	G 3/4"	32	496 x 377 x 461
FD 20	16	20	1.20	120	3	0.41	R 134 a	G 3/4"	34	496 x 377 x 461
FD 25	16	25	1.50	170	3	0.41	R 134 a	G 3/4"	34	496 x 377 x 461
FD 30	16	30	1.80	250	3	0.41	R 134 a	G 3/4"	34	496 x 377 x 461
FD 40	16	40	2.40	200	3	0.48	R 134 a	G 1"	57	688 x 389 x 604
FD 50	16	50	3.00	200	3	0.69	R 134 a	G 1"	58	688 x 389 x 604
FD 60	13	60	3.60	220	3	0.63	R 134 a	G 1"	80	726 x 482 x 804
FD 70	13	70	4.20	220	3	0.87	R 134 a	G 1"	81	726 x 482 x 804
FD 95	13	95	5.70	220	3	1.18	R 134 a	G 1"	87	726 x 482 x 804
FD 120	14	120	7.20	110	3	1.00	R 410 a	G 1 1/2"	170	836 x 661 x 982
FD 150	14	150	9.00	150	3	1.00	R 410 a	G 1 1/2"	170	836 x 661 x 982
FD 185	14	185	11.10	220	3	1.40	R 410 a	G 2 1/2"	185	916 x 802 x 982
FD 220	14	220	13.20	120	3	1.70	R 410 a	G 2 1/2"	197	916 x 802 x 982
FD 245	14	245	14.70	180	3	1.90	R 410 a	G 2 1/2"	197	916 x 802 x 982
FD 285	14	285	17.10	220	3	2.10	R 410 a	G 2 1/2"	197	916 x 802 x 982
FD 310 – 40°C	14	310	18.60	230	3	2.80	R 410 a	G 3"	198	850 x 986 x 1190
FD 310 – 46°C	14	310	18.60	230	3	2.80	R 410 a	G 3"	200	850 x 986 x 1190
FD 310 – 50°C	14	310	18.60	230	3	2.90	R 410 a	G 3"	202	850 x 986 x 1190
FD 410 – 40°C	14	410	24.60	210	3	3.00	R 410 a	G 3"	220	850 x 986 x 1375
FD 410 – 46°C	14	410	24.60	210	3	4.60	R 410 a	G 3"	240	850 x 1250 x 1375
FD 410 – 50°C	14	410	24.60	210	3	4.80	R 410 a	G 3"	290	850 x 1525 x 1375
FD 510 – 40°C	14	510	30.60	200	3	4.50	R 410 a	G 3"	260	850 x 1250 x 1375
FD 510 – 46°C	14	510	30.60	200	3	6.40	R 410 a	G 3"	310	850 x 1525 x 1375
FD 510 – 50°C	14	510	30.60	200	3	6.90	R 410 a	G 3"	315	850 x 1525 x 1375
FD 610	14	610	36.60	170	3	4.80	R 410 a	DN 100	320	1040 x 1060 x 1580
FD 760	14	760	45.60	170	3	5.30	R 410 a	DN 100	380	1245 x 1060 x 1580
FD 870	14	870	52.20	150	3	6.60	R 410 a	DN 150	400	1245 x 1060 x 1580
FD 1010	14	1010	60.60	170	3	7.40	R 410 a	DN 150	460	1580 x 1060 x 1580
FD 1250	13	1250	75.00	240	3	8.30	R 404 a	DN 150	860	1350 x 1640 x 1880
FD 1400	13	1400	84.00	240	3	8.50	R 404 a	DN 200	940	1350 x 1640 x 1880
FD 1600	13	1600	96.00	130	3	13.6	R 404 a	DN 200	1280	1350 x 1640 x 1880
FD 2000	13	2000	120.00	220	3	20.00	R 404 a	DN 200	1345	1350 x 1640 x 1880

⁽¹⁾ Capacity FAD based on 20°C, 1 bar. Reference conditions: working pressure 7 bar, compressed air temperature 35°C, ambient temperature 25°C, relative humidity on entry 100%, pressure dewpoint 3°C.

Type	Maximum working pressure	Capacity FAD ⁽¹⁾		Pressure loss	Pressure dewpoint	Power consumption	Refrigerant	Inlet/outlet connections	Approx. weight	Dimensions
	bar	l/s	m ³ /min	mbar	approx. °C	kW				L x W x H
FD – Refrigerant dryer, air-cooled, 20-bar versions										
FD 5–20	20	7.3	0.44	40	3	0.20	R 134 a	G 3/4"	27	496 × 377 × 461
FD 10–20	20	14.4	0.87	90	3	0.20	R 134 a	G 3/4"	27	496 × 377 × 461
FD 15–20	20	21.8	1.31	100	3	0.33	R 134 a	G 3/4"	32	496 × 377 × 461
FD 20–20	20	27.6	1.65	100	3	0.41	R 134 a	G 3/4"	34	496 × 377 × 461
FD 25–20	20	34.8	2.09	140	3	0.70	R 134 a	G 3/4"	34	496 × 377 × 461
FD 30–20	20	43.5	2.61	200	3	0.70	R 134 a	G 1"	34	496 × 377 × 461
FD 40–20	20	58.0	3.48	160	3	0.70	R 134 a	G 1"	57	688 × 389 × 604
FD 50–20	20	72.5	4.35	160	3	0.70	R 134 a	G 1"	58	688 × 389 × 604
FD – Refrigerant dryer, water-cooled										
FD 310W	14	310	18.6	230	3	2.00	R 410 a	G 3"	180	850 × 986 × 1190
FD 410W	14	410	24.6	210	3	2.40	R 410 a	G 3"	240	850 × 1250 × 1375
FD 510W	14	510	30.6	200	3	4.10	R 410 a	G 3"	260	850 × 1250 × 1375
FD 610W	14	610	36.6	170	3	3.10	R 410 a	DN 100	350	1245 × 1060 × 1580
FD 760W	14	760	45.6	170	3	3.60	R 410 a	DN 100	360	1245 × 1060 × 1580
FD 870W	14	870	52.2	150	3	4.50	R 410 a	DN 150	370	1245 × 1060 × 1580
FD 1010W	14	1010	60.6	170	3	5.10	R 410 a	DN 150	380	1245 × 1060 × 1580
FD 1250W	13	1250	75.0	240	3	8.30	R 404 a	DN 150	860	1350 × 1640 × 1880
FD 1400W	13	1400	84.0	200	3	8.50	R 404 a	DN 200	940	1350 × 1640 × 1880
FD 1600W	13	1600	96.0	200	3	13.60	R 404 a	DN 200	1280	1350 × 1640 × 1880
FD 2000W	13	2000	120.0	250	3	20.00	R 404 a	DN 200	1345	1350 × 1640 × 1880

⁽¹⁾ Capacity FAD based on 20°C, 1 bar. Reference conditions: working pressure 7 bar, compressed air temperature 35°C, ambient temperature 25°C, relative humidity on entry 100%, pressure dewpoint 3°C.

FD Refrigerant air dryers, 6-4000 l/s, 13-8480 cfm



FD 4000 W VSD

Integrated speed regulation (VSD)

Some FD refrigerant dryers have a built-in VSD control, which adapts the energy consumption to the actual used compressed air, significantly reducing energy consumption. Compared to conventional dryers, this saves up to 70%. The compressor runs with variable speeds to maintain a stable dewpoint. The speed of the refrigerant compressor is adapted to the inlet conditions, so less energy is needed for lower loads.

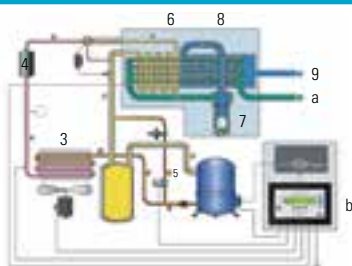

Functional diagram for the FD-VSD series

- | | |
|----------------------------------|---|
| 1 Liquid separator | 7 Water separator |
| 2 Refrigerant compressor | 8 Air heat exchanger |
| 3 Condenser | 9 Outlet for dried air |
| 4 Refrigerant dryer/filter | a Inlet for moist air |
| 5 Control device | b Elektronikon® (control and regulating unit) |
| 6 Air/refrigerant heat exchanger | |



Reduce your total lifecycle cost by up to **50%** with Atlas Copco's FD dryers

Up to 50% savings on Indirect energy costs

Up to 50% savings on Direct energy costs

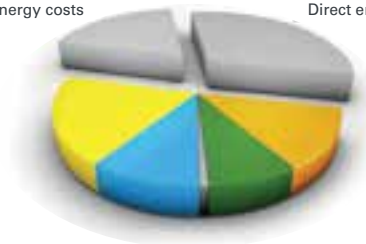

FD 2000 VSD

FD VSD Refrigeration dryers - with speed control

Type	Maximum working pressure	Capacity FAD ⁽¹⁾		Pressure loss	Pressure dewpoint	Power consumption	Refrigerant	Inlet/outlet connections	Approx. weight	Dimensions L x W x H
	bar	l/s	m ³ /min	mbar	approx.°C	kW			kg	mm
FD – VSD series – Refrigerant dryer, air-cooled										
FD 760 VSD	14	up to 760	up to 45.6	170	3	5.3	R 410 a	DN 100	380	1245 x 1060 x 1580
FD 870 VSD	14	up to 870	up to 52.2	150	3	5.8	R 410 a	DN 150	400	1245 x 1060 x 1580
FD 1010 VSD	14	up to 1010	up to 60.6	170	3	6.6	R 410 a	DN 150	460	1580 x 1060 x 1580
FD 1250 VSD	13	up to 1250	up to 75.0	240	3	10.1	R 404 a	DN 200	750	1300 x 1350 x 1880
FD 1400 VSD	13	up to 1400	up to 84.0	240	3	9.1	R 404 a	DN 200	820	1300 x 1350 x 1880
FD 1600 VSD	13	up to 1600	up to 96.0	130	3	13.3	R 404 a	DN 200	1110	2120 x 1350 x 1880
FD 2000 VSD	13	up to 2000	up to 120.0	220	3	19.5	R 404 a	DN 200	1155	2120 x 1350 x 1880
FD – VSD series – Refrigerant dryer, water-cooled										
FD 760 WVSD	14	up to 760	up to 45.6	90	3	3.3	R 410 a	DN 100	410	1580 x 1060 x 1580
FD 870 WVSD	14	up to 870	up to 52.2	120	3	4.2	R 410 a	DN 150	410	1580 x 1060 x 1580
FD 1010 WVSD	14	up to 1010	up to 60.6	170	3	5.6	R 410 a	DN 150	410	1580 x 1060 x 1580
FD 1250 WVSD	13	up to 1250	up to 75.0	240	3	9.9	R 404 a	DN 200	750	1300 x 1350 x 1880
FD 1400 WVSD	13	up to 1400	up to 84.0	240	3	8.5	R 404 a	DN 200	820	1300 x 1350 x 1880
FD 1600 WVSD	13	up to 1600	up to 96.0	130	3	9.3	R 404 a	DN 200	1110	2120 x 1350 x 1880
FD 2000 WVSD	13	up to 2000	up to 120.0	220	3	13.5	R 404 a	DN 200	1155	2120 x 1350 x 1880
FD 2400 WVSD	13	up to 2400	up to 144.0	230	3	18.3	R 404 a	DN 200	1180	2000 x 1350 x 1880
FD 4000 WVSD	13	up to 4000	up to 240.0	220	3	28.9	R 404 a	DN 250	2010	2200 x 2300 x 1910

⁽¹⁾ Flow based on 20°C, 1 bar. Reference conditions: working pressure 7 bar, compressed air temperature 35°C, ambient temperature 25°C, relative humidity on entry 100%, pressure dewpoint 3°C.

Heatless desiccant air dryers, 32-1600 l/s, 68-3392 cfm

CD

Atlas Copco's CD heatless desiccant air dryers are designed for a long lifetime of reliable operation. Using only compressed air as a purge, they provide you with the clean, dry air you need to extend the life of your equipment and ensure the quality of your end product. They are available in a range of sizes with a pressure dewpoint as low as $-40^{\circ}\text{C}/-40^{\circ}\text{F}$, and come in an IP54 protected cubicle.

CUSTOMER BENEFITS

- Reliability** – Atlas Copco's CD desiccant dryers eliminate system failures, production downtime and costly repairs by removing moisture from compressed air with a pressure dewpoint as low as $-40^{\circ}\text{C}/-40^{\circ}\text{F}$.
- Reduced energy costs** – Optimally sized pipes and valves ensure a limited pressure drop. Options are available to increase the efficiency and reduce the energy consumption of your CD dryer.
- Space-saving** – The CD's all-in-one design leads to a small footprint, saving valuable space in your facility.
- Efficient control** – The control system – fitted in an IP54 cubicle for easy cabling and safety – ensures proper operation of your CD dryer.
- Low maintenance** – Delivered ready for use, installation of your CD dryer is straightforward, cutting costly production downtime. All internal components are easily accessible to facilitate maintenance. The use of high-grade desiccant and high-quality valves results in three-year maintenance intervals.



CD 3+ – 1400+



CD 630

Type	Flow		Pressure loss (without filter) bar	Filter sizes (recommended)			Weight kg	Dimensions mm		
				Pre-filter		Afterfilter		mm		
	l/s	m ³ /hr		1 μm 0.1 ppm	0.01 μm 0.01 ppm	1 μm		L	W	H
CD 360	360	1296	0.19	DD310+	PD310+	DDp310+	650	1173	1116	1854
CD 480	480	1728	0.14	DD425+	PD425+	DDp425+	970	1776	988	2549
CD 630	630	2268	0.14	DD630	PD630	DDp630	1240	1884	843	2604
CD 970	970	3492	0.12	DD970	PD970	DDp970	2010	2359	1039	2643
CD 1260	1260	4536	0.12	DD1260	PD1260	DDp1260	2470	2472	1039	2636
CD 1600	1600	5760	0.11	DD1600	PD1600	DDp1600	3560	2693	1428	2576

Heatless desiccant air dryers, 1-1400 l/s, 2-2968 cfm CD⁺

Atlas Copco's CD⁺ heatless desiccant dryers protect your systems and processes. Their robust design ensures they operate with total reliability and deliver a constant, stable dewpoint in full load conditions and even during a temporary overload. The result is dry and clean compressed air for a broad range of industrial applications.

Technological innovations ensure that this air is produced reliably and cost-effectively. Our CD⁺ dryers are available in a range of sizes with a guaranteed dewpoint down to -40°C/-40°F (optionally -70°C/-100°F), and come in an IP54 protected cubicle.

CUSTOMER BENEFITS

- **High reliability** – Atlas Copco's CD⁺ desiccant dryers eliminate system failures, production downtime and costly repairs by removing moisture from compressed air with a pressure dewpoint as low as -70°C/-100°F. Up to 30% desiccant overfill and the long lifetime of the desiccant further enhance reliability.
- **Maximum energy savings** – CD⁺ dryers incorporate energy-saving features that cut your carbon footprint. A low pressure drop below 0.2 bar/2.9 psi drives down energy costs. Dewpoint sensing and control adapts the energy consumption to the real load of the dryer.
- **Easy installation** – Your CD⁺ dryer is delivered ready for use with silencers, sensors and the control unit already wired and connected.
- **Advanced control and monitoring** – The advanced Elektronikon® control and monitoring system takes continuous care of your CD⁺ dryer to ensure optimal efficiency.
- **Minimum maintenance** – All internal components are easily accessible to facilitate maintenance. The use of high-grade desiccant and durable valves extends maintenance intervals beyond the standard three years.
- **Durability** – A proven, rugged design for the switching valves, the most important moving components in the dryer, significantly improves the lifetime of your CD⁺ dryer.

CD 185⁺

CD 630

CD 25⁺

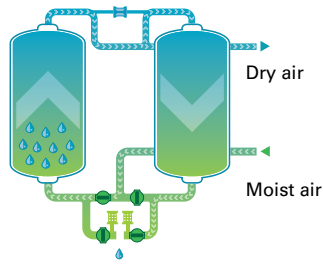

Heatless desiccant air dryers

Dry air from the outlet of the dryer container is released to the outside air pressure and guided through the saturated desiccant, where it takes up the adsorbed moisture.

After the desorption the blow-off valve is closed, and the container is put under pressure again.

Type	Capacity FAD		Pressure loss (without filter)	Filter sizes (recommended)			Weight	Dimensions		
	l/s	m ³ /hr		Pre-filter		Afterfilter		mm		
			bar	1 µm 0.1 ppm	0.01 µm 0.01 ppm	1 µm	kg	L	W	H
CD 1 ⁺	1	3.6	0.20	DD3	PD3	integrated	7	106	172	540
CD 1.5 ⁺	1.5	5.4	0.20	DD3	PD3	integrated	8	106	172	590
CD 2 ⁺	2	7.2	0.20	DD3	PD3	integrated	9	106	172	720
CD 2.5 ⁺	2.5	9.0	0.20	DD3	PD3	integrated	10	106	172	835
CD 3 ⁺	3	10.8	0.20	DD3	PD3	integrated	11	106	172	855
CD 5 ⁺	5	18.0	0.20	DD3	PD3	integrated	19	149	295	640
CD 7 ⁺	7	25.2	0.20	DD3	PD3	integrated	22	149	295	725
CD 10 ⁺	10	36.0	0.20	DD3	PD3	integrated	25	149	295	875
CD 12 ⁺	12	43.2	0.20	DD3	PD3	integrated	29	149	295	1015
CD 17 ⁺	17	61.2	0.20	DD3	PD3	integrated	35	149	295	1270
CD 22 ⁺	22	79.2	0.35	DD3	PD3	integrated	44	149	295	1505
CD 25 ⁺	25	90	0.06	DD32	PD32	DDp32	50	550	201	1233
CD 30 ⁺	30	108	0.09	DD32	PD32	DDp32	50	550	201	1233
CD 35 ⁺	35	126	0.10	DD32	PD32	DDp32	60	550	201	1478
CD 50 ⁺	50	180	0.32	DD60	PD60	DDp60	80	550	201	1846
CD 60 ⁺	60	216	0.12	DD60	PD60	DDp60	100	550	364	1233
CD 70 ⁺	70	252	0.16	DD60	PD60	DDp60	120	550	364	1479
CD 80 ⁺	80	288	0.33	DD120	PD120	DDp120	160	550	364	1846
CD 100 ⁺	100	360	0.35	DD120	PD120	DDp120	160	550	364	1846
CD 145 ⁺	145	522	0.43	DD150	PD150	DDp150	240	550	526	1846
CD 110 ⁺	107	385	0.12	DD120	PD120	DDp120	340	950	728	1695
CD 150 ⁺	150	540	0.16	DD150	PD150	DDp150	415	1089	848	1731
CD 185 ⁺	185	666	0.20	DD175	PD175	DDp175	445	1089	848	1731
CD 250 ⁺	250	900	0.14	DD280	PD280	DDp280	600	1106	960	1816
CD 300 ⁺	300	1080	0.19	DD280	PD280	DDp280	650	1173	1116	1854
CD 330 ⁺	330	1188	0.10	DD310 ⁺	PD310 ⁺	DDp310 ⁺	950	1088	1776	2537
CD 400 ⁺	400	1440	0.10	DD425 ⁺	PD425 ⁺	DDp425 ⁺	1030	1088	1776	2537
CD 550 ⁺	550	1980	0.10	DD550 ⁺	PD550 ⁺	DDp550 ⁺	1310	1091	1884	2592
CD 850 ⁺	850	3060	0.10	DD850 ⁺	PD850 ⁺	DDp850 ⁺	2120	1259	2359	2655
CD 1100 ⁺	1100	3960	0.10	DD1100 ⁺	PD1100 ⁺	DDp1100 ⁺	2600	1259	2472	2637
CD 1400 ⁺	1400	5040	0.11	DD1400 ⁺	PD1400 ⁺	DDp1400 ⁺	3700	1428	2693	2576

Blower purge desiccant air dryers, 360-1600 l/s, 763-3392 cfm BD

Atlas Copco's BD blower purge desiccant air dryers are designed for a long lifetime of reliable operation. They use a combination of air from an external blower, heat and minimal compressed air, and incorporate unique, patented technological innovations and energy-saving options. BD dryers provide you with the clean, dry air you need to extend the life of your equipment and ensure the quality of your end product. They are available in a range of sizes with a pressure dewpoint as low as -40°C/-40°F, and come in an IP54 protected cubicle.

CUSTOMER BENEFITS

- **Reliability** – Atlas Copco's BD desiccant dryers eliminate system failures, production downtime and costly repairs by removing moisture from compressed air with a pressure dewpoint as low as -40°C/-40°F.
- **Reduced energy costs** – Optimally sized pipes and valves ensure a limited pressure drop. Options are available to increase the efficiency and reduce the energy consumption of your BD dryer.
- **Space-saving** – The BD's all-in-one design leads to a small footprint, saving valuable space in your facility.
- **Efficient control** – The control system – fitted in an IP54 cubicle for easy cabling and safety – ensures proper operation of your BD dryer.
- **Low maintenance** – Delivered ready for use, installation of your BD dryer is straightforward, cutting costly production downtime. All internal components are easily accessible to facilitate maintenance. The use of high-grade desiccant and high-quality valves results in three-year maintenance intervals.



BD 970

Electronic dewpoint control

When the dewpoint reaches a preset value, the dryer automatically switches between the towers. This extends the drying time and results in considerable power savings, instead of changing the tower functions periodically. The power savings can be as high as 70%. The dewpoint is continuously monitored and indicated on the dryer display.

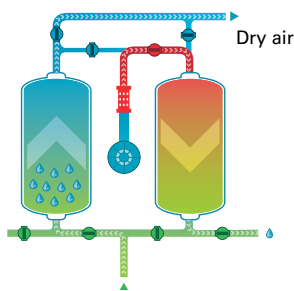

Functional diagram for the BD desiccant dryer

Blower purge desiccant air dryers

The blower sucks in ambient air and blows it across the external heating element. The heated air is then guided from top to bottom through the saturated desiccant and absorbs the adsorbed moisture.

Cooling

Purging: After heating, the hot desiccant is cooled in the container. For the cooling, dry compressed air is passed from the outlet of the adsorption container from top to bottom through the hot reactivated container, and thus released.

Type	Capacity FAD		Average power input	Pressure loss (without filter)	Filter sizes (recommended)			Weight	Dimensions		
	l/s	m ³ /hr			Pre-filter		Afterfilter		mm		
			kW	bar	1 µm 0.1 ppm	0.01 µm 0.01 ppm	1 µm	kg	L	W	H
BD 360	360	1296	8.4	0.16	DD310+	PD310+	DDp310+	1160	1100	1028	1829
BD 480	480	1728	10.4	0.16	DD425+	PD425+	DDp425+	1275	1764	1024	2558
BD 630	630	2268	14.8	0.16	DD630	PD630	DDp630	1560	1884	1024	2612
BD 970	970	3492	21.8	0.16	DD970	PD970	DDp970	2540	2359	1175	2702
BD 1260	1260	4536	27.7	0.16	DD1260	PD1260	DDp1260	3035	2472	1175	2681
BD 1600	1600	5760	35.3	0.11	DD1600	PD1600	DDp1600	4100	2720	2199	2548

Blower purge desiccant air dryers, 100-3000 l/s, 212-6360 cfm

BD⁺

Atlas Copco's BD⁺ blower purge desiccant air dryers are designed for outstanding industrial performance and a long lifetime of reliable operation. They eliminate moisture completely before it can cause any damage to your compressed air net or production equipment. BD⁺ dryers use a combination of air from an external blower, heat and minimal compressed air, and incorporate unique, patented technological innovations and energy-saving options. BD⁺ dryers are available in a range of sizes with a guaranteed dewpoint down to -40°C /-40°F (optionally -70°C/-100°F), and come in an IP54 protected cubicle.

CUSTOMER BENEFITS

- **High reliability** – BD⁺ dryers eliminate system failures, production downtime and costly repairs by removing moisture from compressed air with a pressure dewpoint as low as -70°C/-100°F. Up to 30% desiccant overfill and the long lifetime of the desiccant further enhance reliability.
- **Maximum energy savings** – BD⁺ dryers incorporate energy-saving features that cut your carbon footprint. A low pressure drop below 0.2 bar/2.9 psi drives down energy costs. Dewpoint sensing and control adapts the energy consumption to the real load of the dryer.
- **Easy installation** – Your BD⁺ dryer is delivered ready for use with heaters, sensors and the control unit already wired and connected.
- **Advanced control and monitoring** – The advanced Elektronikon[®] control and monitoring system gives clear indication of dryer status, operation cycle and alarms. It includes alarms for low Inlet pressure, specify bar(a), (e), blower, heater and valve operation, plus limit switches, pressure and temperature sensors.
- **Minimum maintenance** – All internal components are easily accessible to facilitate maintenance. The use of high-grade desiccant and high-quality valves extends maintenance intervals beyond three years.
- **Durability** – A proven, rugged design for the switching valves and the blower, the most important moving components in the dryer, significantly improves the lifetime of your BD⁺ dryer.



BD 1100⁺

Type	Capacity FAD		Average power input	Pressure loss (without filter)	Filter sizes (recommended)			Weight	Dimensions		
					Pre-filter		Afterfilter		mm		
	l/s	m ³ /hr			kW	bar	1 µm 0.1 ppm		0.01 µm 0.01 ppm	1 µm	kg
Purge air cooling											
BD 100 ⁺	100	360	3.0	0.20	DD120	PD120	DDp120	640	1250	770	1720
BD 150 ⁺	150	540	3.0	0.20	DD150	PD150	DDp150	680	1300	870	1770
BD 185 ⁺	185	666	5.0	0.20	DD175	PD175	DDp175	710	1300	870	1770
BD 250 ⁺	250	900	5.5	0.20	DD280	PD280	DDp280	775	1345	955	1816
BD 300 ⁺	300	1080	5.5	0.20	DD310 ⁺	PD310 ⁺	DDp310 ⁺	820	1425	1010	1853
BD 330 ⁺	330	1188	9.3	0.12	DD310 ⁺	PD310 ⁺	DDp310 ⁺	1190	1764	1024	2558
BD 400 ⁺	400	1440	10.2	0.12	DD425 ⁺	PD425 ⁺	DDp425 ⁺	1300	1764	1024	2558
BD 550 ⁺	550	1980	12.0	0.12	DD550 ⁺	PD550 ⁺	DDp550 ⁺	1620	1884	1024	2612
BD 850 ⁺	850	3060	17.1	0.12	DD850 ⁺	PD850 ⁺	DDp850 ⁺	2600	2359	1175	2702
BD 1100 ⁺	1100	3960	24.2	0.12	DD1100 ⁺	PD1100 ⁺	DDp1100 ⁺	3040	2472	1175	2681
BD 1400 ⁺	1400	5040	33.0	0.10	DD1400 ⁺	PD1400 ⁺	DDp1400 ⁺	4100	2720	2199	2548
BD 1800 ⁺	1800	6480	39.0	0.16	DD1800 ⁺	PD1800 ⁺	DDp1800 ⁺	4700	2793	2199	2548
BD 2200 ⁺	2200	7920	55.0	0.22	DD2200 ⁺	PD2200 ⁺	DDp2200 ⁺	5600	2993	2199	2548
BD 3000 ⁺	3000	10800	69.0	0.18	DD3000 ⁺	PD3000 ⁺	DDp3000 ⁺	7600	3350	2417	2893
Purge-free air cooling (Zero Purge)											
BD 330 ⁺	330	1188	8.6	0.12	DD310 ⁺	PD310 ⁺	DDp310 ⁺	1420	1764	1024	2558
BD 400 ⁺	400	1440	10.7	0.12	DD425 ⁺	PD425 ⁺	DDp425 ⁺	1545	1764	1024	2558
BD 550 ⁺	550	1980	13.2	0.12	DD550 ⁺	PD550 ⁺	DDp550 ⁺	1910	1884	1024	2612
BD 850 ⁺	850	3060	23.4	0.12	DD850 ⁺	PD850 ⁺	DDp850 ⁺	2960	2359	1175	2702
BD 1100 ⁺	1100	3960	32.4	0.12	DD1100 ⁺	PD1100 ⁺	DDp1100 ⁺	3490	2472	1175	2681
BD 1400 ⁺	1400	5040	37.0	0.10	DD1400 ⁺	PD1400 ⁺	DDp1400 ⁺	4450	2720	2639	2548
BD 1800 ⁺	1800	6480	45.0	0.16	DD1800 ⁺	PD1800 ⁺	DDp1800 ⁺	5050	2793	2663	2548
BD 2200 ⁺	2200	7920	62.0	0.22	DD2200 ⁺	PD2200 ⁺	DDp2200 ⁺	5950	2993	2775	2548
BD 3000 ⁺	3000	10800	79.0	0.18	DD3000 ⁺	PD3000 ⁺	DDp3000 ⁺	7950	3350	2923	2893

Heat of compression rotary drum dryers, 88-2500 l/s, 185-5297 cfm

MD

For high-quality, dry air downstream from your oil-free screw and centrifugal compressors, Atlas Copco's MD rotary drum dryers meet your needs perfectly. Using heat of compression – which requires negligible energy input – they are the perfect solution for a wide range of applications requiring pressure dewpoints as low as $-25^{\circ}\text{C}/-13^{\circ}\text{F}$. MD dryers are also often selected for applications where refrigerated dryers are suitable ($+3^{\circ}\text{C}/37^{\circ}\text{F}$ PDP) due to the significant energy savings they offer. You benefit from a reliable process, impeccable end products, and the lowest total cost of ownership. Compared to other desiccant dryers that can consume up to 15% of the compressed air, the MD dryer guarantees 100% Capacity FAD capacity at the output.

CUSTOMER BENEFITS

- **Maximum energy savings** – The energy consumption of MD dryers is negligible: only 0.12 kW (water cooled version). MD dryers are characterized by no loss of compressed air, zero purge by design, low pressure drop and no pre- and after-filtration requirements. These factors contribute to additional energy savings and increased efficiency. A Variable Speed Drive (VSD) dryer version is available to match VSD compressors.
- **Low maintenance** – The combination of an easy to service vessel, minimal maintenance downtime and long service intervals reduces your maintenance time and costs.
- **Environmentally friendly** – MD dryers are totally oil-free and use no Freon or CFCs, and a minimal amount of desiccant (only 5-10% of conventional adsorption dryers). 95% of all components can be recycled, and the units have very low noise levels.
- **Small footprint** – The small footprint of MD dryers means they take up minimal space in your facility.



MD 2500 VSD

Type	Compressor type	Max. operating pressure	Dewpoint ⁽¹⁾	Input	Weight approximately	Dimensions L x B x H
		bar	°C	kW	kg	mm
MD - Heat of compression rotary drum dryers, air cooled						
MD 200	ZT 55-90	10.5	-30	1.04	460	852 x 1433 x 1347
MD 300	ZT 110-145	10.5	-30	1.04	500	852 x 1442 x 1545
MD 400	ZT 160-200	10.5	-30	1.04	500	852 x 1442 x 1545
MD 600	ZT 200-275	10.5	-30	1.34	950	1194 x 1893 x 1796
MD - Heat of compression rotary drum dryers, air cooled and speed control						
MD 200 VSD	ZT 75-90 VD	10.5	-25	1.04	460	852 x 1442 x 1545
MD 400 VSD	ZT 132-160 VSD	10.5	-25	1.04	500	852 x 1442 x 1545
MD 800 VSD	ZT 250-315 VSD	10.5	-25	1.34	950	1194 x 1893 x 1796
MD - Heat of compression rotary drum dryers, water cooled						
MD 200W	ZR 55-90	10.5	-30	0.12	410	819 x 990 x 1347
MD 300W	ZR 110-145	10.5	-30	0.12	440	819 x 997 x 1545
MD 400W	ZR 160-200	10.5	-30	0.12	440	819 x 997 x 1545
MD 600W	ZR 200-275	10.5	-30	0.12	900	1163 x 1345 x 1609
MD 1000W	ZR 300-425	10.5	-30	0.12	1000	1156 x 1369 x 2057
MD 1800W	ZR 450-750	10.5	-30	0.12	1500	1290 x 1716 x 2283
MD - Heat of compression rotary drum dryers, water cooled and speed control						
MD 200W VSD	ZR 75-90 VSD	10.5	-25	0.15	410	819 x 990 x 1347
MD 400W VSD	ZR 132-160 VSD	10.5	-25	0.15	440	819 x 997 x 1545
MD 800W VSD	ZR 250-315 VSD	10.5	-25	0.15	900	1163 x 1346 x 1796
MD 1100W VSD	ZR 400 VSD	10.5	-25	0.15	1000	1156 x 1369 x 2057
MD 1300W VSD	ZR 500 VSD	10.5	-25	0.15	1000	1156 x 1369 x 2057
MD 2100W VSD	ZR 700 VSD	10.5	-25	0.15	1500	1289 x 1721 x 2353
MD 2500W VSD	ZR 900 VSD	10.5	-25	0.15	1500	1289 x 1721 x 2353

⁽¹⁾ At full load and at reference conditions: working pressure 7 bar Inlet pressure, specify bar(a), (e) 1 bar, intake and coolant temperature 20 °C, rel. Humidity of the intake 60%

Heat of compression rotary drum dryers, 1800-2500 l/s, 3816-5297 cfm ND

For high quality, dry air downstream from your oil-free compressor, Atlas Copco's ND rotary drum dryers meet your needs perfectly. Providing energy-efficient drying by using heat of compression, they are the perfect solution for applications requiring pressure dew points as low as $-45^{\circ}\text{C}/-49^{\circ}\text{F}$. You benefit from a reliable process, impeccable end products, and the lowest total cost of ownership. What's more, they offer outstanding energy efficiency. Compared to other desiccant dryers that can consume up to 15% of the compressed air, the ND dryer guarantees 100% Capacity FAD capacity at the output.

CUSTOMER BENEFITS

- **High efficiency** – ND dryers are characterized by no loss of compressed air, zero purge by design, low pressure drop and no filtration requirements, all of which contribute to increased efficiency. A Variable Speed Drive (VSD) dryer version is available to match VSD compressors.
- **Low maintenance** – The combination of an easy to service vessel, minimal maintenance downtime and long service intervals reduces your maintenance time and costs.
- **Environmentally friendly** – ND dryers are totally oil-free and use no Freon or CFCs, and a minimal amount of desiccant (only 5-10% of conventional adsorption dryers). 95% of all components can be recycled, and the units have very low noise levels.
- **Small footprint** – The small footprint of ND dryers means they take up minimal space in your facility.



Options
Stainless steel interconnecting piping
Pressure dew point sensor
Variable Speed Drive variant (for VSD compressors)
By-pass for ND 1000
Silicone-free rotor

Type	Capacity FAD			Rated heater power*		Outlet connections	Dimensions						Weight	
							mm			in				
	l/s	m ³ /hr	cfm	kW	hp	flanged	A	B	C	A	B	C	kg	lbs
ND 1000	1080	3888	2290	9	12	DIN 100/ANSI 4"	1337	1711	2058	53	67	81	1300	2870
ND 1100 VSD	1145	4122	2430	9	12	DIN 100/ANSI 4"	1337	1711	2058	53	67	81	1300	2870
ND 1300 VSD	1275	4590	2700	9	12	DIN 100/ANSI 4"	1337	1711	2058	53	67	81	1300	2870
ND 1800	2075	7470	4399	15	20	DIN 125/ANSI 6"	1497	1879	2322	59	74	91	1750	3850
ND 2000	2100	7560	4452	36	48	DIN 125/ANSI 6"	1497	1879	2411	59	74	95	1800	3960
ND 2100VSD	2100	7560	4452	15	20	DIN 125/ANSI 6"	1497	1879	2392	59	74	94	1750	3850
ND 2500VSD	2500	9000	5300	15	20	DIN 125/ANSI 6"	1497	1879	2392	59	74	94	1750	3850

* Actual power consumption is lower than the stated heater power and would depend on the conditions.

Reference conditions:

Performance data per ISO 7183:2007.

Heat-of-compression desiccant air dryers, 550-3600 l/s, 1165 - 7628 cfm

XD⁺

Atlas Copco's XD⁺ heat-of-compression desiccant dryers combine high drying performance with minimal energy use. The result is best-in-class air quality for the ZH centrifugal compressor series, Z screw compressors and other oil-free air compressors. They guarantee a stable pressure dew point down to -40°C/-40°F (optionally -70°C/-100°F) without temperature or dew point peaks.

CUSTOMER BENEFITS

- **Maximum energy savings** – The XD's patented zero purge solution does not consume any compressed air, while the high-performance desiccant minimizes energy consumption during regeneration. The low pressure drop of all individual components results in an overall low pressure drop. Advanced controls further reduce your total energy bill.
- **Optimal uptime** – XD⁺ dryers are renowned for their durability. Coolers, process valves, heaters and strainer are all made from stainless steel; all piping is fully galvanized; and the cooler shells are internally coated. Corrosion resistance results in extended lifetime and minimum maintenance downtime.
- **High reliability** – The high-performance desiccant has a low sensitivity to aging and a high resistance to acid condensate, which translate into a long lifetime. All process stainless steel valves are standard equipped with reliable inductive limit switches.
- **Easy installation and maintenance** – The modular design, consisting of a flanged piping skid and instrumentation and two flanged vessels, allows easy installation on site, reducing the installation cost to a minimum and ensuring quick commissioning. All controls and switches are connected to the Elektronikon® controller, which arrives fully programmed on site to cut installation time and cost.
- **Low noise** – The patented zero purge dryers exclude all need for purge air. As there is no purge, noise levels are extremely low.



XD 1100 ZP

Dryer Type	Inlet Flow FAD 7 bar (e)/100 psig ⁽¹⁾					Pressure Drop (excluding filters)		Inlet/Outlet Connections	Filter sizes (recommended)	Dimensions						Weight	
	l/s	m ³ /hr	cfm	l/W	hp	bar	psi			50Hz: G/PN 16 60 Hz : NPT/DN	After-Filter 1p/m	mm			In		
								L	W			H	L	W	H		
XD 550 ⁺	550	1980	1166	3.4	4.59	0.39	5.656	80	Ddp550 ⁺	1884	1589	2612	74.2	62.6	103	2196	4876
XD 850 ⁺	850	3060	1802	5.1	6.9	0.39	5.656	100	Ddp850 ⁺	2359	1936	2752	92.9	76.2	108	3320	7377
XD 1100 ⁺	1100	3960	2332	6.5	8.8	0.39	5.656	100	Ddp1100 ⁺	2473	1936	2734	97.4	76.2	108	3835	8518
XD 1400 ⁺	1400	5040	2968	8.4	11.3	0.35	5.076	150	Ddp1400 ⁺	4120	2290	2556	162	90.2	101	5921	1314
XD 1800 ⁺	1800	6480	3816	10.8	14.6	0.35	5.076	150	Ddp1800 ⁺	4120	2292	2560	162	90.2	101	6550	1464
XD 2200 ⁺	2200	7920	4664	13.2	17.8	0.35	5.076	150	Ddp2200 ⁺	4120	2292	2680	162	90.2	106	7366	1635
XD 3000 ⁺	3000	10800	6360	18	24.3	0.35	5.076	200	Ddp3000 ⁺	5617	2724	2866	221	107	113	9531	2116
XD 3600 ⁺	3600	12960	7632	21.6	29.2	0.35	5.076	200	Ddp4000 ⁺	5617	2724	2866	221	107	113	10390	2306

Membrane dryers

SD

Atlas Copco's SD membrane dryers with pre-filters remove oil, particles and moisture from compressed air in the most demanding conditions. They ensure the lowest pressure drop and purge air loss for the highest possible efficiency – saving you time and money through your production process. From small spaces to environments with fluctuating ambient temperatures, SD dryers can perform in a wide variety of harsh and critical conditions. Two models are available, each with a range of performance, to offer you the exact air treatment you require.

CUSTOMER BENEFITS

- **Versatility** – SD dryers perform in all sorts of areas: small spaces, areas where flexible mounting is required, high vibration areas and in widely fluctuating temperatures.
- **Safety assurance** – SD dryers provide dry air in environments with strict safety or environmental requirements. These include low flow environments, areas without an electrical supply, explosion-proof facilities, noise-sensitive and corrosion-sensitive areas.
- **Clean and dry air for critical applications** – Because they are not powered by electricity, SD dryers function safely in environments that must be explosion-proof, such as laboratories. Thanks to their quiet operation, they can be used close to the workplace.

- **Optimal efficiency** – SD membrane dryers contain thousands of hollow fibers with an innovative inner coating. Compared to conventional membrane dryers, this unique coating increases the separation efficiency between water vapor and oxygen and nitrogen, giving an unprecedented low air leakage and the lowest purge air loss.
- **Flexibility in choice** – SD dryers are available in two models, each with a different Pressure Dew Point Suppression. This choice of performance ensures that, regardless of your production environment and demands, there is an SD dryer to meet your needs.
- **Energy savings** – Due to the straightforward design of the SD dryer, compressed air has no twists and turns to make inside the housing. This leads to minimal pressure drop and utmost efficiency throughout the drying process.



SDP - Membrane Dryer - pressure dew point 32 °C									
Type	Max. working pressure bar	Capacity FAD ⁽¹⁾		Pressure dew point reduction ca. °C	Pressure drop mbar	Pneumatic connection	Supplied filter	Weight ⁽²⁾ approximately kg	Dimensions ∅ / L mm
		l/s	m ³ /min						
SD 1 P	7	3.0	0.16	32	0.10	G 3/8"	DD+PD 9	3.0	55 / 532
SD 2 P	7	5.0	0.30	32	0.17	G 3/8"	DD+PD 9	3.0	55 / 532
SD 3 P	7	9.0	0.54	32	0.17	G 1/2"	DD+PD 9	4.0	78 / 733
SD 4 P	7	14.0	0.84	32	0.27	G 1/2"	DD+PD 17	4.2	78 / 733
SD 5 P	7	19.0	1.14	32	0.17	G 1/2"	DD+PD 17	5.3	99 / 709
SD 6 P	7	25.0	1.50	32	0.24	G 1/2"	DD+PD 32	5.3	99 / 709
SD 7 P	7	35.0	2.10	32	0.18	G 1/2"	DD+PD 32	7.9	125 / 732

⁽¹⁾ Based on 25 °C, 1 bar, 100% relative humidity. Reference conditions: Working pressure: 7, 10, 13 bar, temperature 35 °C, relative humidity 100%.

⁽²⁾ weight (net) including DD / PD filters combination

SDP - Membrane Dryer - pressure dew point 32 °C									
Type	Max. working pressure	Capacity FAD ⁽¹⁾		Pressure dew point reduction	Pressure drop	Pneumatic connection	Supplied filter	Weight ⁽²⁾ approximately	Dimensions Ø / L
		bar	l/s						
SD 1 P	10	4.0	0.24	32	0.10	G 3/8"	DD + PD 9	3.0	55 / 532
SD 2 P	10	7.0	0.42	32	0.17	G 3/8"	DD + PD 9	3.0	55 / 532
SD 3 P	10	12.0	0.72	32	0.17	G 1/2"	DD + PD 9	4.0	78 / 733
SD 4 P	10	19.0	1.14	32	0.27	G 1/2"	DD + PD 17	4.2	78 / 733
SD 5 P	10	25.0	1.50	32	0.17	G 1/2"	DD + PD 17	5.3	99 / 709
SD 6 P	10	34.0	2.04	32	0.24	G 1/2"	DD + PD 32	5.3	99 / 709
SD 7 P	10	44.0	2.64	32	0.20	G 1/2"	DD + PD 32	7.9	125 / 732
SD 1 P	13	5.0	0.30	32	0.10	G 3/8"	DD + PD 9	3.0	55 / 532
SD 2 P	13	8.5	0.51	32	0.17	G 3/8"	DD + PD 9	3.0	55 / 532
SD 3 P	13	14.0	0.84	32	0.17	G 1/2"	DD + PD 9	4.0	78 / 733
SD 4 P	13	22.0	1.32	32	0.27	G 1/2"	DD + PD 17	4.2	78 / 733
SD 5 P	13	32.0	1.92	32	0.18	G 1/2"	DD + PD 32	5.7	99 / 709
SD 6 P	13	42.0	2.52	32	0.25	G 1/2"	DD + PD 32	5.3	99 / 709
SD 7 P	13	55.0	3.30	32	0.19	G 3/4"	DD + PD 44	8.9	125 / 732

⁽¹⁾ Based on 25 °C, 1 bar, 100% relative humidity. Reference conditions: Working pressure: 7, 10, 13 bar, temperature 35 °C, relative humidity 100%.

⁽²⁾ weight (net) including DD / PD filters combination

SD / N - Membrane Dryer - pressure dew point 55 °C									
Type	Max. working pressure	Capacity FAD ⁽¹⁾		Pressure dew point reduction	Pressure drop	Pneumatic connection	Supplied filter	Weight ⁽²⁾ approximately	Dimensions Ø / L
		bar	l/s						
SD 1 N	7	1.5	0.09	55	0.08	G 3/8"	DD + PD 9	3.0	55 / 715
SD 2 N	7	3.5	0.21	55	0.25	G 3/8"	DD + PD 9	3.2	55 / 1020
SD 3 N	7	6.0	0.36	55	0.16	G 1/2"	DD + PD 9	4.7	78 / 1076
SD 4 N	7	9.0	0.54	55	0.25	G 1/2"	DD + PD 9	4.7	78 / 1076
SD 5 N	7	13.0	0.78	55	0.18	G 1/2"	DD + PD 17	6.1	99 / 1076
SD 6 N	7	17.0	1.02	55	0.25	G 1/2"	DD + PD 17	6.1	99 / 1076
SD 7 N	7	26.0	1.56	55	0.25	G 1/2"	DD + PD 32	9.7	125 / 1113
SD 1 N	10	2.0	0.12	55	0.08	G 3/8"	DD + PD 9	3.0	55 / 715
SD 2 N	10	4.5	0.27	55	0.24	G 3/8"	DD + PD 9	3.2	55 / 1020
SD 3 N	10	8.0	0.48	55	0.15	G 1/2"	DD + PD 9	4.7	78 / 1076
SD 4 N	10	12.0	0.72	55	0.24	G 1/2"	DD + PD 9	4.7	78 / 1076
SD 5 N	10	18.0	1.08	55	0.19	G 1/2"	DD + PD 17	6.1	99 / 1076
SD 6 N	10	22.0	1.32	55	0.24	G 1/2"	DD + PD 17	6.1	99 / 1076
SD 7 N	10	35.0	2.10	55	0.24	G 1/2"	DD + PD 32	9.7	125 / 1113
SD 1 N	13	2.5	0.15	55	0.08	G 3/8"	DD + PD 9	3.0	55 / 715
SD 2 N	13	5.5	0.33	55	0.24	G 3/8"	DD + PD 9	3.2	55 / 1020
SD 3 N	13	10.0	0.60	55	0.15	G 1/2"	DD + PD 9	4.7	78 / 1076
SD 4 N	13	15.0	0.90	55	0.24	G 1/2"	DD + PD 9	4.7	78 / 1076
SD 5 N	13	23.0	1.38	55	0.19	G 1/2"	DD + PD 17	6.1	99 / 1076
SD 6 N	13	28.0	1.68	55	0.25	G 1/2"	DD + PD 17	6.1	99 / 1076
SD 7 N	13	45.0	2.70	55	0.25	G 1/2"	DD + PD 32	9.7	125 / 1113

⁽¹⁾ Based on 25 °C, 1 bar, 100% relative humidity. Reference conditions: Working pressure: 7, 10, 13 bar, temperature 35 °C, relative humidity 100%.

⁽²⁾ weight (net) including DD / PD filters combination

Purification units for breathable air

BAP / BAP⁺

Breathing air purifiers turn compressed air into certified breathing air. High quality air is of vital importance to many industries but even more so in breathing air applications.

Atlas Copco BAP/BAP⁺ breathing air purifiers are designed to offer protection against a range of contaminants that may be present in a compressed air fed breathing air system. These include fumes, oil, vapors, gases, solid particles and micro-organisms. Complying with International Breathing Air standards, the BAP/BAP⁺ breathing air purifier range assures a safe working environment in a wide range of applications.

CUSTOMER BENEFITS

- **Breathtaking air quality** – High quality air is of vital importance to many industries, but nowhere as literally as in breathing air applications. The purity of the compressed air for breathing air is crucial to assure a safe working environment in a wide range of applications like asbestos removal, tank cleaning, sand blasting and others. For this reason, Atlas Copco has designed the BAP/BAP⁺ breathing air purifier range. The BAP/BAP⁺ takes air from any regular compressor and treats it to become ultra clean. It consists of a number of components, which together, after proper commissioning, produce air with a quality matching the Pharmacopoeia that will comply with the European Norm EN 12021 (Compressed air for breathing apparatus).
- **Clean air in seven-step filtration** – The BAP/BAP⁺ purification package for converting a compressed air source into breathing quality air. Your BAP/BAP⁺ package is independently certified to provide medical air in compliance with the European Pharmacopoeia.
 - The BAP/BAP⁺ has 7 stages of active purification:
 - A water separator to remove liquid water
 - A bulk aerosol filter eliminates oil and water
 - A fine coalescing filter removes even smaller particles of oil and water
 - A desiccant dryer takes out any remaining water and CO₂
 - Activated carbon removes gaseous impurities
 - A catalyst takes care of a CO oxidation
 - A bacteria filter eliminates bacteria and fine particles. This bacteria filter is an Atlas Copco PDp filter, which has been externally tested and certified as a bacterial filter.
- **More advantages of the BAP**
 - Compact system, offering reliable breathing air
 - Every BAP/BAP⁺ breathing air purifier comes pre-assembled and tested to provide simple installation
 - Complying with the European Norm EN 12021 (Compressed air for breathing apparatus)
 - Challenge test to ensure the BAP meets international regulations



International compliance

Atlas Copco's Breathing Air Purifiers comply with OSHA Grade D, NFPA-99, CSA Z180.1-00, CGA G7.1-1997, EN12021, BS 4275, European Pharmacopoeia and other International Breathing Air Standards.

7-145 BAP / BAP⁺

Type	Inlet pressure, specify bar(a), (e)		Capacity FAD			Purge %	Pressure drop	
	bar(e)	psig	l/s	m ³ /h	cfm		dP, mbar	psi
BAP 7	7	102	7.0	25.2	14.8	19.0	510	7.4
	10	145	8.4	30.2	17.8	15.8	510	7.4
	13	188	9.4	33.8	19.9	14.1	510	7.4
BAP 13	7	102	13.0	46.8	27.5	19.0	530	7.7
	10	145	15.6	56.2	33.1	15.8	530	7.7
	13	188	17.5	63.0	37.1	14.1	530	7.7
BAP 25 / BAP 25 ⁺	7	102	25.0	90.0	53.0	18.0	560	8.1
	10	145	30.0	108.0	63.6	15.0	560	8.1
	13	188	33.8	121.7	71.6	13.3	560	8.1
BAP 35 / BAP 35 ⁺	7	102	35.0	126.0	74.2	18.0	600	8.7
	10	145	42.0	151.2	89.0	15.0	600	8.7
	13	188	47.3	170.3	100.2	13.3	600	8.7
BAP 50 / BAP 50 ⁺	7	102	50.0	180.0	106.0	19.0	820	11.9
	10	145	60.0	216.0	127.1	15.8	820	11.9
	13	188	67.5	243.0	143.0	14.1	820	11.9
BAP 70 / BAP 70 ⁺	7	102	70.0	252.0	148.3	18.0	660	9.6
	10	145	84.0	302.4	178.0	15.0	660	9.6
	13	188	94.5	340.2	200.2	13.3	660	9.6
BAP 80 / BAP 80 ⁺	7	102	80.0	288.0	169.5	18.0	700	10.2
	10	145	96.0	345.6	203.4	15.0	700	10.2
	13	188	108.0	388.8	228.9	13.3	700	10.2
BAP 100 / BAP 100 ⁺	7	102	100.0	360.0	211.9	19.0	820	11.9
	10	145	120.0	432.0	254.3	15.8	820	11.9
	13	188	135.0	486.0	286.1	14.1	820	11.9
BAP 145 / BAP 145 ⁺	7	102	145.0	522.0	307.3	19.0	800	11.6
	10	145	174.0	626.4	368.7	15.8	800	11.6
	13	188	195.8	704.9	414.9	14.1	800	11.6

Type	MED					MED ⁺				
	Weight, kg	Length, mm	Width, mm	Height, mm	NTP connec- tion	Weight, kg	Length, mm	Width, mm	Height, mm	NTP connection
BAP 7 / BAP 7 ⁺	184	950	650	885	1/2"	214	950	650	1851	1/2"
BAP 13 / BAP 13 ⁺	201	950	650	1075	1/2"	231	950	650	1851	1/2"
BAP 25 / BAP 25 ⁺	245	950	650	1300	1/2"	275	950	650	1851	1/2"
BAP 35 / BAP 35 ⁺	271	950	650	1545	1/2"	301	950	650	1851	1/2"
BAP 50 / BAP 50 ⁺	315	950	650	1915	1"	345	950	650	1858	1"
BAP 70 / BAP 70 ⁺	446	1250	850	1545	1"	476	1250	850	1840	1"
BAP 80 / BAP 80 ⁺	494	1250	850	1915	1 1/2"	524	1250	850	1840	1"
BAP 100 / BAP 100 ⁺	502	1250	850	1915	1 1/2"	532	1250	850	1840	1"
BAP 145 / BAP 145 ⁺	620	1250	850	1915	1 1/2"	650	1250	850	1856	1"

Compressed air purification

Something else you should consider

Could the finest oil drops or moisture or the smallest dust grain affect your manufacturing processes? Or even affect the quality of your products; in the worst case scenario, destroying your products or rendering them useless? Then you need to process the compressed air accordingly. Suitable dust filters, activated carbon absorbers, condensate drains & oil-water separators.

Your compressed air system will include diverse processing components; particularly if you produce your compressed air with oil-lubricated or oil-injected compressors. But even if you are using oil-free compressors, you may need filters, a modern piping system or other accessories. The following pages present a variety of solutions for the most varied requirements.

Our dust, fine, ultra-fine and activated carbon filters eliminate even the smallest foreign particles or aerosols. You no longer need to worry about impurities when you pass your compressed air through these processing components, as we can

effectively and safely separate out dust particles up to $0.01 \mu\text{m}$ in diameter and oil carry-over up to 0.003 mg/m^3 of air.

You can use our oil-water separators to process your condensate from oil-injected compressors, because this condensate always structurally contains a proportion of oil, which you must remove before you can guide water into the public sewage network. You'll also save disposal costs. You should install oil-water separators when you order a compressor.

To remove the condensate itself from the compressed air network, we provide reliable condensate drains – with electronic measuring of the level in the reservoir and automatic discharge.

You'll find a very special "separation technology" in our nitrogen generators: these units retain the oxygen from the (compressed) air using a carbon molecular sieve, producing nitrogen with purity levels of up to 99.999%. The machines pay for themselves quickly compared to the widespread way of working with hired bottle bundles.

Compressed air filters

DD+, DDp+, PD+, PDp+, QD+ filters

Atlas Copco's DD+, DDp+, PD+, PDp+ and QD+ filters efficiently reduce all types of contamination in your compressed air stream to protect your investment, equipment and processes. Our innovative filtration solutions are engineered to cost effectively provide the best quality air and meet today's increasing quality demands.

CUSTOMER BENEFITS

- **Reduced energy costs** – Designed for maximum contaminant removal, our filter range offers significant energy savings thanks to their optimal air flow path with low resistance. The filters' carefully engineered housing and cartridge ensure minimal pressure drops.
- **Solid reliability** – High performance stainless steel filter cores ensure durability of the cartridges. Protection paper avoids direct contact between the filter media and the stainless steel filter core.
- **High efficiency** – Top quality filter media in a deep-wrap layered composition ensure extremely high filtration efficiency, a low pressure drop and long cartridge lifetime. The flow path through housing and cartridge is optimized to reduce air turbulence and pressure drop.
- **Low running costs** – A unique and highly efficient head design reduces pressure drop and cuts your operational costs.



Compressed air filters: + range 7 bar

Filter size	Inlet capacity		Pressure		Connections	Dimensions						Weight			
	l/s	cfm	bar(e)	psig		A		B		C		D		kg	lbs
						mm	in	mm	in	mm	in	mm	in	kg	lbs
DD+, DDp+, PD+, PDp+, QD+															
10	10	21	7	102	3/8	90	3.54	61	2.40	268	10.55	75	2.95	1	2.2
20	20	42	7	102	1/2	90	3.54	61	2.40	268	10.55	75	2.95	1.1	2.4
35	35	74	7	102	1/2	90	3.54	61	2.40	323	12.72	75	2.95	1.3	2.9
50	50	106	7	102	3/4 & 1	110	4.33	98.5	3.88	374	14.72	75	2.95	1.6	4.2
70	70	148	7	102	1	110	4.33	98.5	3.88	414	16.3	75	2.95	2.1	4.6
130	130	275	7	102	1-1/2	140	5.51	105	4.13	520	20.47	100	3.94	4.2	9.3
170	170	360	7	102	1-1/2	140	5.51	105	4.13	603	23.74	100	3.94	4.5	9.9
210	210	445	7	102	1-1/2	140	5.51	105	4.13	603	23.74	100	3.94	4.6	10.1
310	310	657	7	102	2 & 2-1/2	179	7.05	121	4.76	689	27.13	150	5.91	6.9	15.2
425	425	901	7	102	3	210	8.27	128	5.04	791	31.14	200	7.87	11	24.2
550	550	1165	7	102	3	210	8.27	128	5.04	961	37.83	200	7.87	12.6	27.8
550F	550	1165	7	102	DN80	370	14.6	190	7.5	1295	51	1375	54.1	76	167.6
850F	850	1801	7	102	DN100	510	20.1	230	9.1	1360	53.5	1500	59.1	141	310.9
1100F	1100	2331	7	102	DN100	510	20.1	230	9.1	1360	53.5	1500	59.1	143	415.3
1400F	1400	2967	7	102	DN150	620	24.4	290	11.4	1480	58.3	1560	61.4	210	463
1800F	1800	3814	7	102	DN150	640	25.2	285	11.2	1555	61.2	1640	64.6	176	388
2200F	2200	4662	7	102	DN150	640	25.2	285	11.2	1555	61.2	1640	64.6	178	392.4
3000F	3000	6357	7	102	DN200	820	32.3	400	15.7	1745	68.7	1710	67.3	420	925.9
4000F	4000	8476	7	102	DN200	820	32.3	400	15.7	1745	68.7	1710	67.3	428	943.6
5000F	5000	10595	7	102	DN250	820	32.3	400	15.7	1745	68.7	1710	67.3	432	952.4
6000F	6000	12714	7	102	DN250	920	32.3	550	18.9	2085	80.3	1625	64	594	1034
7000F	7000	14833	7	102	DN300	920	36.2	550	21.7	2085	82.1	1625	64	597	1479.3
8000F	8000	16952	7	102	DN300	1040	40.9	525	20.7	2070	81.5	1625	64	1140	1984.2

	DD+	DDp+	PD+	PDp+	QD+
Dry pressure drop (mbar)	NA	85	NA	100	140
Wet pressure drop (mbar)	180	NA	215	NA	NA
Max oil carry-over (mg/m ³)	0.07	NA	0.008	NA	0.003
Count efficiency (% at MPPS)	NA	99.92	NA	99.98	NA

* inlet oil concentration 10 mg/m³

** after DD+ PD+

Inlet pressure, specify bar(a), (e) (bar)	1	2	3	4	5	6	7	8	10	12	14	16
Inlet pressure, specify bar(a), (e) (psig)	15	29	44	58	72.5	87	102	116	145	174	203	232
Correction factor	0.38	0.53	0.65	0.75	0.83	0.92	1	1.06	1.2	1.31	1.41	1.5

Compressed air filters: + range 20 bar

Filter size	Inlet capacity		Pressure		Connections	Dimensions				Weight			
	I/s	cfm	bar(e)	psig		A		C		D		kg	lbs
						mm	in	mm	in	mm	in		
DD+, DDp+, PD+, PDp+, QD+													
15	15	32	20	290	3/8	90	3.54	268	10.55	75	2.95	1	2.2
32	32	68	20	290	3/8	90	3.54	268	10.55	75	2.95	1.1	2.4
55	55	117	20	290	1/2	90	3.54	323	12.72	75	2.95	1.3	2.9
80	80	170	20	290	3/4	110	4.33	374	14.72	75	2.95	1.9	4.2
110	110	233	20	290	3/4	110	4.33	414	16.3	75	2.95	2.1	4.6
200	200	424	20	290	1-1/2	140	5.51	520	20.47	100	3.94	4.2	9.3
270	270	572	20	290	1-1/2	140	5.51	603	23.74	100	3.94	4.5	9.9
330	330	699	20	290	1-1/2	140	5.51	603	23.74	100	3.94	4.6	10.1
490	490	1038	20	290	2	179	7.05	689	27.13	100	3.94	6.9	15.2

	DD+	DDp+	PD+	PDp+	QD+
Dry pressure drop (mbar)	NA	85	NA	100	140
Wet pressure drop (mbar)	180	NA	215	NA	NA
Max oil carry-over (mg/m ³)	0.07*	NA	0.008*	NA	0.003**
Count efficiency (% at MPPS)	NA	99.92	NA	99.98	NA

* inlet oil concentration 10 mg/m³

** after DD+ PD+

Inlet pressure (bar)	14	16	18	20
Inlet pressure (psig)	203	232	261	290
Correction factor	0.9	0.95	1	1.05

Water separators and drains

WSD 25-750 / WD 80 / EWD 50-1500

Atlas Copco's WSD water separators are delivered as standard with our HD and TD after-coolers. They can also be installed in any point of your air net. The WD 80 drain valve provides completely automatic drainage of the condensate which collects at the bottom of the air receiver. The range of EWD electronically controlled condensate drains provides safe, dependable and economical condensate management.

CUSTOMER BENEFITS

- **Minimal maintenance** – Maintenance-free with no moving parts, the water separators have an automatic and manual drain.
- **High reliability** – The reliable automatic drain devices prevent condensed water from building up in the coolers.
- **Energy savings** – The intelligent drain function monitors condensate build-up with liquid level sensors and evacuates the condensate only when necessary, thus avoiding wastage of compressed air and giving considerable energy savings.
- **Flexible installation** – A wide range of different EWD drains is available for oil contaminated condensate and also may be provided with additional hard coating for use with oil-free and aggressive condensate.



WSD 25-750



TD 08-650



WD 80



HD 4-96

Type	Maximum working pressure	Capacity FAD ⁽¹⁾		Operating temperature		Compressed air connection	Approx. weight	Dimensions L x W x H
	bar	l/s	m ³ /min	min°C	max°C			
WSD – Water separator with automatic and manual drain								
WSD 25	20	25	1.5	1	70	G 1"	2.5	150 x 85 x 275
WSD 80	20	80	4.8	1	70	G 1 1/2"	3.5	185 x 130 x 432
WSD 250	20	250	15.0	1	70	G 2 1/2"	12.5	230 x 160 x 532
WSD 750	16	750	45.0	1	70	²⁾	15.0	298 x 194 x 627
WD – Condensate drain								
WD 80	16	80	4.8	1	70	G 1/2"	2.7	132 x 132 x 182

⁽¹⁾ Based on 20°C, 1 bar. Reference conditions: 7 bar working pressure, inlet temperature 30°C.

Type	Maximum working pressure ⁽¹⁾	Capacity FAD ⁽²⁾		Pressure loss	Compressed air outlet temperature	Installed motor power	Compressed air connection	Approx. weight	Dimensions L x W x H
	bar	l/s	m ³ /min						
TD – Aftercooler, air-cooled									
TD 08	10.5/20	8	0.48	0.12	35	0.05	G 1/2"	6	270 x 130 x 225
TD 25	10.5/20	25	1.50	0.13	35	0.12	G 1"	19	460 x 391 x 658
TD 50	10.5/20	50	3.00	0.21	35	0.18	G 1"	23	560 x 437 x 735
TD 150	10.5/20	150	9.00	0.13	35	0.75	G 2 1/2"	53	740 x 479 x 1160
TD 300	10.5/20	300	18.00	0.14	35	0.75	G 2"	73	960 x 493 x 1280
TD 650	10.5/20	650	39.00	0.16	35	2.20	DN 100	185	1410 x 770 x 1525

⁽¹⁾ 20 bar up to maximum compressed air inlet temperature 130°C, 10.5 bar up to maximum 200°C.

⁽²⁾ Based on 20°C, 1 bar, with reference conditions: working pressure 7 bar, inlet temperature 160°C, ambient temperature 20°C.

Note: DL = Compressed air. Voltage 400 V/50 Hz (TD 08 and 230 V). Other voltages available on request.

Type	Maximum working pressure ⁽¹⁾	Capacity FAD ⁽²⁾		Pressure loss	Compressed air outlet temperature	Water connection	Compressed air connection		Approx. weight	Dimensions L x W x H
		l/s	m ³ /min				Inlet	Outlet		
HD – Aftercooler, water-cooled										
HD 4	20.0	67	4	150	27	G 3/8"	G 1 1/2"	G 1 1/2"	55	344 x 170 x 1840
HD 8	20.0	133	8	200	27	G 1/2"	DN 65	DN 65	78	475 x 215 x 1973
HD 11	20.0	183	11	190	26	G 1/2"	DN 65	DN 65	85	483 x 230 x 1975
HD 16	10.5	267	16	160	28	G 3/4"	DN 100	DN 80	180	645 x 500 x 2083
HD 32	10.5	533	32	190	28	G 1"	DN 100	DN 80	210	635 x 500 x 2083
HD 48	10.5	800	48	190	28	G 1 1/4"	DN 150	2 x DN 80	380	1032 x 490 x 2112
HD 64	10.5	1067	64	190	28	G 1 1/4"	DN 150	2 x DN 80	410	1032 x 490 x 2112
HD 96	10.5	1600	96	190	28	G 1 1/2"	DN 175	3 x DN 80	430	1412 x 490 x 2139

⁽¹⁾ Maximum compressed air inlet temperature: 220°C.

⁽²⁾ Based on 20°C, 1 bar, with reference conditions: water inlet temperature of 20°C, water heating of 15°C, working pressure 7 bar, inlet temperature 160°C.

Note: DL = Compressed air

Activated carbon tower, 20-310 l/s, 42-657 cfm QDT

In the pharmaceutical, food & beverage, electronic and other industries where air purity is critical, you often need to remove residual oil vapors and odors from the compressed air supply. That is exactly what Atlas Copco's high-efficiency carbon filter does. The QDT activated carbon towers will, through the process of adsorption, reduce the residual oil content to lower than 0.003 mg/m³ at 35°C/95°F and 7 bar inlet pressure. The pressure drop is low and stays minimal during the lifetime of the filter. Only an activated carbon tower is able to provide Class 1 clean air in accordance with ISO 8573-1.



CUSTOMER BENEFITS

- **Maximum oil vapor removal**
- **Pressure drop stays low**
- **Highest reliability**
- **Easy maintenance**

Filter size	Nominal capacity ⁽¹⁾		Connections G or NPt	Dimension						Weight	
				Height		Length		Width			
	l/s	cfm		mm	in	mm	in	mm	in	kg	lbs
QDT											
QDT 20	20	42	1/2	490	19	223	9	190	7	10	22
QDT 45	45	95	1	715	28	223	9	190	7	15	33
QDT 60	60	127	1	840	33	223	9	190	7	18	40
QDT 95	95	201	1	715	28	387	15	190	7	29	64
QDT 125	125	265	1 1/2	840	33	387	15	190	7	34	75
QDT 150	150	318	1 1/2	715	28	551	22	190	7	42	93
QDT 185	185	392	1 1/2	840	33	551	22	190	7	50	110
QDT 245	245	519	1 1/2	840	33	715	28	190	7	67	148
QDT 310	310	657	1 1/2	840	33	879	35	190	7	84	185

⁽¹⁾ At reference conditions:

Inlet pressure 7 bar(g)/102 psig, inlet temperature 35°C/95°F.

For other compressed air inlet temperatures, please multiply the filter capacity by the following correction factor (Kt):

Inlet temperature °C	20	25	30	35	40	45	50	55	60
Inlet temperature °F	68	77	86	95	104	113	122	131	140
Correction factor	1.67	1.43	1.25	1	0.71	0.56	0.37	0.25	0.19

For other compressed air inlet pressures, please multiply the filter capacity by the following correction factor (Kp):

Inlet pressure bar(g)	3	4	5	6	7	8	9	10	11	12	13
Inlet pressure psig	44	58	73	87	102	116	131	145	160	174	189
Correction factor	0.57	0.77	0.83	1	1	1	1	1.05	1.05	1.11	1.18

Example:

What is the capacity of a QDT 60, working at 8 bar(g)/116 psig with an inlet temperature of 40°C/104°F?

$K_p = 1$ $K_t = 0.71$

Actual capacity = $60 \times 1 \times 0.71 = 42.6$ l/s or 90.3 cfm



Oil/water separator systems for the condensate treatment

OSC and OSD

Atlas Copco's OSD and OSC condensate separators efficiently separate the oil from the water in condensates. The harmless water is drained away and the oil disposed of in an environmentally friendly manner. The OSD condensate treatment package is fully integrated into the compressor, reducing both installation costs and complexity. The OSC free standing units can separate all kinds of condensate from all compressor technologies, giving unparalleled performance and reliability for minimal maintenance.

- Minimal maintenance.
- Reducing lifetime costs.
- Simple, fast and clean cartridge exchange.
- **Benefits of the OSD free-standing units**
 - No oil collection bottle required, so no chance to ruin previously separated condensate.
 - Multiple oil condensate can be easily separated, Polyglycol condensate can be separated, Most condensate emulsions can be separated.

CUSTOMER BENEFITS

- **Benefits of the OSD integrated solution**
 - High efficiency separation for worry-free condensate discharge.
 - Performance independent of filter age.
 - No installation required, saving time and money.
 - Zero footprint, saving space and simplifying placing.



OSC 600

OIL-WATER SEPARATOR

The function of the OSC oil-water separator

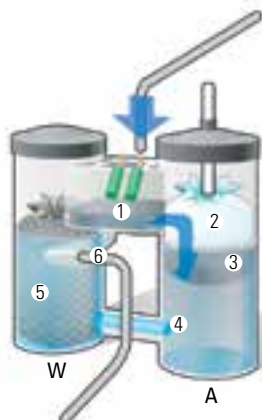

- 1 The condensate is fed through the muffler and expands in the expansion chamber.
 - 2 The oil-water mixture then flows into cylinder A and seeps through the white oil filter. The filter only collects the oil and lets the water pass through.
 - 3 The oil filter floats on the water and absorbs any remaining oil from the surface of the water.
 - The additional weight of the oil causes the filter to gradually sink as the saturation increases. This ensures that clean filter material always remains in contact with the surface of the water.
 - 4 Significantly cleaner condensate flows from cylinder A to cylinder B.
 - 5 Cylinder B contains a bag of activated carbon pellets which absorb any residual oil from the condensate.
 - 6 Clean, virtually oil-free condensate flows from cylinder B and can be easily and safely removed.
- The indicator bar at the top of cylinder A indicates the status of the filter; the more contaminated the filter, the further the bar sinks.
 - The filter must be changed before it is fully immersed in the water.

Type	Capacity FAD ⁽¹⁾ [Cold climate]		Capacity FAD ⁽¹⁾ [Mild climate]		Capacity FAD ⁽¹⁾ [Hot climate]		Oil carry-over condensate mg/l	Approx. weight kg	Dimensions L x W x H mm
	l/s	m ³ /min	l/s	m ³ /min	l/s	m ³ /min			
OSC – Oil-water separator (values for systems with compressors, air receivers, dryers and filters)									
OSC 35	65	3.9	35	2.1	17	1.0	< 20	4	470 x 165 x 600
OSC 95	180	10.8	95	5.7	45	2.7	< 20	13	680 x 255 x 750
OSC 145	270	16.2	145	8.7	70	4.2	< 20	15	680 x 255 x 750
OSC 355	665	39.9	355	21.3	170	10.2	< 20	25	750 x 546 x 900
OSC 600	1150	69.0	605	36.3	290	17.4	< 20	26	750 x 546 x 1030
OSC 825	1550	93.0	825	49.5	400	24.0	< 20	28	945 x 650 x 1100
OSC 1200	2220	133.2	1180	70.8	570	34.2	< 20	30	945 x 695 x 1100
OSC 2400	4440	266.4	2360	141.6	1145	68.7	< 20	60	945 x 1185 x 1100
Type	Capacity FAD ⁽¹⁾ [Cold climate]		Capacity FAD ⁽¹⁾ [Mild climate]		Capacity FAD ⁽¹⁾ [Hot climate]		Oil carry-over condensate mg/l	Approx. weight kg	Dimensions L x W x H mm
	l/s	m ³ /min	l/s	m ³ /min	l/s	m ³ /min			
OSC – Oil-water separator (Values for systems with compressors, air receivers and filters)									
OSC 35	105	6.3	45	2.7	20	1.2	< 20	4	470 x 165 x 600
OSC 95	280	16.8	118	7.1	50	3.0	< 20	13	680 x 255 x 750
OSC 145	415	24.9	175	10.5	75	4.5	< 20	15	680 x 255 x 750
OSC 355	1035	62.1	435	26.1	190	11.4	< 20	25	750 x 546 x 900
OSC 600	1800	108.0	760	46.8	330	19.8	< 20	26	750 x 546 x 1030
OSC 825	2410	144.6	1020	61.2	440	26.4	< 20	28	945 x 650 x 1100
OSC 1200	3450	207.0	1455	87.3	630	37.8	< 20	30	945 x 695 x 1100
OSC 2400	6895	413.7	2910	174.6	1260	75.6	< 20	60	945 x 1185 x 1100

Type	Capacity FAD ⁽¹⁾		Oil content in effluent mg oil/l	Oil canister capacity L	Approx. weight kg	Dimensions L x W x H mm
	l/s	m ³ /min				
OSD – Oil-water separator, integrated						
OSD 22	60	3.6	< 20	1	8	integrated in compressor
OSD 90	250	15.0	< 20	2	9	integrated in compressor
OSD 315	770	46.2	< 20	2	13	integrated in compressor

⁽¹⁾ With reference conditions: suction temperature 35°C, 70% relative humidity. In addition, depending on your compressor type and oil type.

⁽²⁾ Dimensions: integrated in compressor (depending on type).

INDUSTRIAL GASES

On-site gas generators allow you to produce your own nitrogen and oxygen, requiring only a supply of dry compressed air. On-site gases can significantly reduce your costs compared to using bottles or bulk deliveries.

A steady supply of nitrogen is indispensable to many industrial applications. Nitrogen is often referred to as the “5th utility”, next to water, electricity gas and compressed air. So for many companies, on-site nitrogen is the most cost-efficient and most practical way to have a reliable supply of nitrogen.

Oxygen is vital in medical applications, waste water treatment, fish farming and ozone production. Our oxygen and nitrogen generators provide you with the flexible, reliable and cost-efficient solution your production needs.

Nitrogen generators

Atlas Copco offers two different technologies to generate nitrogen: Pressure Swing Adsorption and Membrane.

With these two ranges of nitrogen generators, we can deliver purities between 90% and 99.999% and flows of up to 500 m³/h. Discover which purity levels you need.

The nitrogen purity level depends on the application. "High purity" nitrogen ranges from 97% to 99.999% purity levels. These high levels of purity are crucial to applications such as:

- Food and beverage packaging
- Fruit storage
- CNC machines
- Plastic molding
- Purging

Our nitrogen generators with Pressure Swing Adsorption technology deliver exactly the purity you need for any of these applications.

Some applications require only low levels of purity (between 90 and 99%):

- Fire prevention
- Tire inflation
- Oil & gas
- Marine

For these applications, membrane nitrogen generators are the easiest and most cost-efficient way to product nitrogen.

Oxygen generators

Atlas Copco's oxygen generators are ideal for applications such as:

- Waste water treatment
- Aquaculture
- Medical: enriched breathing air
- Ozone production: water disinfection, food storage, industrial oxidation processes, bleaching, etc...
- Glassworks: increased temperature of ovens
- and many chemical processes

For more information, visit us at
<http://www.atlascopco.com/n2o2>



**PSA nitrogen generators, capacity 1-300 l/s, flow 4-1100 Nm³/h, purity 95-99.999%
NGP**

Page 157



**Membrane nitrogen generators, capacity 1.4-140 l/s, flow 5-500 Nm³/h, purity 95-99%
NGM 1-7**

Page 159



**PSA oxygen generators, capacity 0.6-56 l/s, flow 2-200 Nm³/h, purity 90-95%
OGP**

Page 161

PSA nitrogen generators, capacity 1-300 l/s, Flow 4-1100 Nm³/h purity 95-99.999%

NGP

Atlas Copco's NGP nitrogen generation systems provide a cost-effective, reliable and secure supply of nitrogen. The nitrogen generator's working principle is based on Pressure Swing Adsorption technology, which entails carbon molecular sieves that selectively separate oxygen from nitrogen. The NGP nitrogen generator is perfect for applications such as food and beverage, metal processing, electronics, etc.

CUSTOMER BENEFITS

- **Cost savings** – Our NGP systems are characterized by low operating expenses, operating expenses, and the absence of additional costs such as order processing, refills and delivery charges. Maintenance costs are kept to a minimum too.
- **Convenience** – NGP systems are continuously available, 24/7, to eliminate the risk of a production breakdown due to gas running out.
- **High purity** – We guarantee the nitrogen supply according to your needs, from 95 to 99.999% nitrogen purity.
- **Plug-and-play** – The NGP is delivered ready to use, you only need a supply of dry compressed air.



99.5%	Nitrogen capacity*			Air consumption		
	l/s	cfm	Nm ³ /h	l/s	cfm	Nm ³ /h
NGP 4	1.1	2.4	4.0	4.0	8.5	14.40
NGP 9	2.5	5.3	9.0	8.3	17.7	30.00
NGP 11	3.1	6.5	11.0	10.0	21.2	36.00
NGP 15	4.2	8.8	15.0	15.0	31.8	54.00
NGP 21	5.8	12.4	21.0	20.0	42.4	72.00
NGP 30	8.3	17.7	30.0	28.3	60.0	102.00
NGP 40	11.1	23.5	40.0	39.2	83.0	141.00
NGP 47	13.1	27.7	47.0	43.0	91.1	154.80
NGP 62	17.2	36.5	62.0	52.5	111.2	189.00
NGP 73	20.3	43.0	73.0	60.0	127.1	216.00
NGP 92	25.6	54.1	92.0	90.0	190.7	324.00
NGP 112	31.1	65.9	112.0	106.7	226.0	384.00
NGP 185	51.4	108.9	185.0	165.0	349.6	594.00
NGP 250	69.4	147.1	250.0	226.9	480.8	817.00
NGP 420	116.7	247.2	420.0	396.7	840.5	1428.00
NGP 550	151.4	320.8	545.0	510.0	1080.6	1836.00
NGP 900	250.0	529.7	900.0	800.0	1695.0	2880.00
NGP 1100	305.6	647.4	1100.0	1066.7	2260.1	3840.00

* Performance +/- 5%.

Reference conditions:

Ambient temperature - 20°C

Ambient pressure - 1013 mbar

Unit inlet temperature - 20°C

Inlet pressure, specify bar(a), (e) - 7.5 bar(g)

Unit outlet nitrogen purity - 99.50%

Compressed air inlet quality - ISO8573-1 class 1-4-1

Maximum ambient temperature - 45°C

Minimum compressed air inlet temperature - 5°C

Minimum ambient temperature - 0°C

Minimum compressed air Inlet pressure, specify bar(a), (e) - 4 bar(g)

Maximum compressed air inlet pressure - 10 bar(g)

Minimum nitrogen purity - 95%

Maximum nitrogen purity - 99.999%

Outputs:

Maximum compressed air inlet temperature - 45°C



For more information, please visit

www.atlascopco.com/n2o2

Membrane nitrogen generators, capacity 1.4-140 l/s, Flow 5-500 Nm³/h, purity 95-99%

NGM 1-7

Atlas Copco's NGM membrane nitrogen generators provide a cost-effective, reliable and secure supply of nitrogen. The nitrogen generator's working principle is based on membrane air separation. The membrane allows nitrogen to pass and other gases (like oxygen, water vapor and CO₂) to permeate. The NGM series delivers flows from 5 to 500 Nm³/h and purities from 95% to 99%. These features make the NGM ideal for applications such as fire prevention, tire inflation, oil & gas, marine, packaging and more.

- **Convenience** – NGM systems are continuously available, 24/7, to eliminate the risk of a production breakdown due to gas running out.
- **High purity** – We guarantee the nitrogen supply according to your needs, from 95% to 99% nitrogen purity.
- **Optimal flexibility** – The NGM is available in many sizes and thanks to its modular design, your NGM set-up can be adapted to your specific needs.
- **Efficient control** – To guarantee maximum uptime, continuous surveillance is a must. By properly monitoring your system with the NGM's electronic panel, you decrease downtime as well as save energy, reduce maintenance and increase production throughput.

CUSTOMER BENEFITS

- **Cost savings** – Our NGM systems are characterized by low operating expenses, and the absence of additional costs such as order processing, refills and delivery charges. Maintenance costs are kept to a minimum too.



95% NGM	20°C			7 bar(g)		
	Capacity			Air consumption		
	l/s	cfm	m³/h	l/s	cfm	m³/h
1	3.2	6.7	11.5	8.2	17.4	29.5
2	6.3	13.3	22.7	16.4	34.7	59.0
3	11.1	23.5	39.9	28.9	61.2	104.0
4	22.2	47.0	80.0	57.8	122.5	208.1
5	33.3	70.6	119.9	86.7	183.7	312.1
6	44.4	94.0	159.8	115.6	244.9	416.2
7	55.6	117.8	200.2	144.4	305.9	519.8

Reference conditions:

Ambient temperature: 20°C

Ambient pressure: 1013 mbar

Unit inlet temperature: 20°C

Membrane working pressure: 7 bar(g)

Unit outlet nitrogen purity: 95%

Compressed air inlet quality: ISO8573-1 class 1-4-1

Outputs (Min/Max):

Maximum compressed air inlet temperature: 50°C

Maximum ambient temperature: 50°C

Minimum compressed air inlet temperature: 5°C

Minimum ambient temperature: 0°C

Minimum compressed air Inlet pressure, specify bar(a), (e): 4 bar(g)

Maximum compressed air Inlet pressure, specify bar(a), (e): 13 bar(g)

Minimum nitrogen purity: 90%

Maximum nitrogen purity: 99.5%

Correction Factors for Nitrogen Capacity

Membrane pressure (barg)	Correction factor
7	1.0
8	1.2
9	1.4
10	1.6
11	1.8
12	2.0
13	2.1

Inlet temperature (°C)	Purity (% N ₂)					
	95	96	97	98	99	99.5
5	0.9	0.9	0.9	0.9	0.9	0.9
10	0.9	0.9	0.9	0.9	0.9	0.9
20	1.0	1.0	1.0	1.0	1.0	1.0
30	1.0	1.0	1.0	1.0	1.0	1.0
40	1.1	1.1	1.0	1.0	0.8	0.6
50	1.2	1.1	1.1	1.0	0.8	0.6

For more information, please visit
www.atlascopco.com/n2o2



Sizing example:

NGM 4: 95%, 11 bar, 40°C

Capacity: 22.2 l/s x 1.8 x 1 = 40 l/s

Air consumption: 57.8 l/s x 1.8 x 1.2 = 124.8 l/s

PSA oxygen generators, capacity 0.6-56 l/s, Flow 2-200 Nm³/h, purity 90-95%

OGP

Atlas Copco's OGP oxygen generation systems provide a cost-effective, reliable and secure supply of oxygen. The oxygen generator's working principle is based on Pressure Swing Adsorption technology, with zeolite pellets that selectively isolate oxygen molecules from other molecules in compressed air. The OGP oxygen generator is perfect for applications such as ozone production, waste water treatment, health care, glass industry, etc.

CUSTOMER BENEFITS

- **Cost savings** – Our OGP systems are characterized by low operating expenses and the absence of additional costs such as order processing, refills and delivery charges. Maintenance costs are kept to a minimum too.
- **Convenience** – OGP systems are continuously available, 24/7, to eliminate the risk of a production breakdown due to gas running out.
- **High purity** – We guarantee the oxygen supply according to your needs, from 90 to 95% oxygen purity.
- **Plug-and-play** – The OGP is delivered ready to use, you only need a supply of dry compressed air.



90.00%	Oxygen capacity*			Air consumption		
	l/s	cfm	Nm ³ /h	l/s	cfm	Nm ³ /h
OGP 2	0.6	1.3	2.0	6.7	14.1	22.20
OGP 3	0.9	1.9	3.0	9.0	19.1	30.00
OGP 4	1.1	2.4	3.7	10.8	22.9	36.00
OGP 5	1.4	2.9	4.5	16.2	34.4	54.00
OGP 6	2.0	4.1	6.5	21.6	45.8	72.00
OGP 8	2.3	5.0	7.8	30.6	64.9	102.00
OGP 10	2.9	6.0	9.5	30.6	64.9	102.00
OGP 14	4.2	8.9	14.0	46.5	98.5	154.80
OGP 18	5.5	11.6	18.2	56.8	120.2	189.00
OGP 20	6.0	12.7	20.0	64.9	137.4	216.00
OGP 23	6.9	14.6	23.0	75.7	160.3	252.00
OGP 29	8.6	18.3	28.8	97.3	206.1	324.00
OGP 35	10.4	21.9	34.5	108.1	229.0	360.00
OGP 45	13.4	28.3	44.5	153.1	324.5	510.00
OGP 55	16.5	35.0	55.0	187.4	397.0	624.00
OGP 65	19.5	41.4	65.0	236.0	500.1	786.00
OGP 84	25.2	53.4	84.0	290.1	614.6	966.00
OGP 105	31.5	66.8	105.0	367.5	778.7	1224.00
OGP 160	46.5	98.6	155.0	551.3	1168.1	1836.00
OGP 200	60.1	127.2	200.0	663.0	1404.8	2208.00

* Performance +/- 5%.

Reference conditions:

Ambient temperature	20°C
Ambient pressure	1013 mbar
Unit inlet temperature	20°C
Inlet pressure, specify bar(a), (e)	7.5 bar(g)
Unit outlet oxygen purity	90%
Compressed air inlet quality	ISO8573-1 class 1-4-1

Outputs

Maximum compressed air inlet temperature	45°C
Maximum ambient temperature	45°C
Minimum compressed air inlet temperature	5°C
Minimum ambient temperature	0°C
Minimum compressed air Inlet pressure, specify bar(a), (e)	4 bar(g)
Maximum compressed air Inlet pressure, specify bar(a), (e)	10 bar(g)
Minimum oxygen purity	90%
Maximum oxygen purity	95%



For more information, please visit
www.atlascopco.com/n2o2

VACUUM SOLUTIONS

Vacuum is critical in a wide variety of applications – and the need for vacuum continues to grow, for example in the development of hightech composite materials used in wind farms, aircraft manufacture etc.

Atlas Copco has been developing state-of-the-art high-end vacuum solutions for many years. We have a market-leading status in the ongoing innovation of gas compression techniques such as screw, claw and scroll. Our vacuum specialists are constantly improving the performance of our products, targeting new application areas, and meeting new challenges.

The result is a wide portfolio of vacuum pumps that consistently help our customers become more efficient by lowering the cost of ownership, increasing sustainable productivity and enhancing final product quality.

On atlas-copco.com/vacuum you can find more information on our available vacuum solutions.

Vacuum Pumps

What's your vacuum?

One of the first questions you have to consider is the type of vacuum you need. The vacuum market can be divided into two segments – fine and utility. These two areas of vacuum are very different; they utilize different technologies, products and solutions, and often serve different markets, although there are some overlaps. Pneurop, the European committee of manufacturers of compressors, vacuum pumps, pneumatic tools and allied equipment, sets the limit for rough vacuum as 1 mbar. Atlas Copco's special focus is the rough vacuum segment.

Atlas Copco has been developing state-of-the-art high-end vacuum solutions for many years. We have a market-leading status in the ongoing innovation of gas compression techniques such as screw, claw and scroll. Our vacuum specialists are constantly improving the performance of our products, targeting new application areas, and meeting new challenges.

The result is a wide portfolio of vacuum pumps that consistently help our customers become more efficient by lowering the cost of ownership, increasing sustainable productivity and enhancing final product quality.

Utility vacuum

- Pressure range: 1000 – 1 mbar (hPa).
- Also known as coarse pressure or industrial vacuum.
- Applications include medical, packaging (food/ meat and non-food), paper and printing, power, woodworking, oil and gas.

Fine vacuum

- Pressure range:
 - Medium: 1 – 10⁻⁵ mbar (hPa).
 - High: 10⁻⁵ – 10⁻⁹ mbar (hPa).
 - Ultra-high: 10⁻⁹ – 10⁻¹² mbar (hPa).
- Also known by some customers as scientific vacuum.
- Applications include semiconductor manufacturing, analytics, R&D labs, thin film coatings.



Download a QR Reader and scan the code for more information on our vacuum solutions.

www.atlascopco.com/vacuum

Oil-sealed rotary vane vacuum pumps, 20-365 m³/h, 12-215 cfm GVS 20-300

Atlas Copco's GVS 20-300 range is a series of robust and reliable oil-sealed rotary vane vacuum pumps, packed with innovative features.

Oil-sealed rotary vane vacuum pumps are ideal for critical applications like packaging and material handling in the general industry. With 8 models, offering pumping speeds of between 20 and 365 m³/h, you will definitely find the right model for your specific application.

CUSTOMER BENEFITS

- **High reliability** – Thanks to a rugged design and optimal oil retention at all operating pressures. An inlet non-return valve protects the pump against counter rotation.
- **Plug and play installation** – Easy installation thanks to a compact, space-saving design.
- **Easy maintenance** – Wear is low thanks to optimally selected shaft speeds. Servicing can be done by the same engineer that services your compressed air equipment.
- **Low noise and vibration levels throughout the pressure range**



Type	Pumping speed		Ultimate pressure ⁽²⁾		Motor size		Water handling capability		Motor supply specification
	m ³ /h	cfm	mbar (hPa)	torr	1 ph	3 ph	Vapor limit		
					kW	kW	mbar	kg/h	
GVS 20	20	10.5	2	1.50	0.75	Optional	35	0.5	1 - 230V 50Hz
	21	12.3	2	1.50	0.9	Optional	35	0.5	1 - 230V 60Hz
GVS 25	25	14.7	0.5	0.38	0.75	0.75	40	0.7	1 - 230V 50Hz
	29	17.0	0.5	0.38	0.9	0.9	40	0.7	1 - 230V 60Hz
GVS 40	40	23.5	0.5	0.38	1.1	1.1	30	0.9	3 - 175-260/300-450V 50Hz
	48	28.3	0.5	0.38	1.35	1.35	30	0.9	3 - 200-300/346-520V 60Hz
GVS 60	60	35.3	0.5	0.38	-	1.5	40	1.8	3 - 175-260/300-450V 50Hz
	75	44.1	0.5	0.38	-	1.8	40	1.8	3 - 200-300/346-520V 60Hz
GVS 100	105	61.8	0.5	0.38	-	2.2	30	2.2	IE2 motor 3-230/400V 50Hz ⁽¹⁾
	125	73.6	0.5	0.38	-	3	30	2.2	3-IE2 motor 208-230V/265-460V 60Hz ⁽¹⁾
GVS 150	150	88.3	0.5	0.38	-	3.3	25	2.5	IE2 motor 3-230/400V 50Hz ⁽¹⁾
	180	106.0	0.5	0.38	-	3.7	25	2.5	3-IE2 motor 208-230V/265-460V 60Hz ⁽¹⁾
GVS 200	205	120.7	0.5	0.38	-	5.5	25	3.5	IE2 motor 3-230/400V 50Hz ⁽¹⁾
	245	144.2	0.5	0.38	-	6.6	25	3.5	3-IE2 motor 208-230V/265-460V 60Hz ⁽¹⁾
GVS 300	305	179.5	0.5	0.38	-	7.5	25	5	IE2 motor 3-230/400V 50Hz ⁽¹⁾
	365	214.8	0.5	0.38	-	8.6	25	5	3-IE2 motor 208-230V/265-460V 60Hz ⁽¹⁾

⁽¹⁾ Smaller non-IE2 motors are available for continuous low pressure duties.

⁽²⁾ With gas ballast valve open. All units achieve better than 0.5 mbar with gas ballast closed.

Oil-sealed rotary screw vacuum pumps, 557-5734 m³/h, 328-3377 cfm GHS 630-4800

Atlas Copco's oil-sealed rotary screw vacuum pumps bring reliable, efficient rough vacuum to the general industry. The GHS 630-4800 combines a robust oil-sealed rotary screw technology with Atlas Copco's advanced screw element design.

Oil-sealed rotary screw vacuum pumps are particularly efficient in the operating pressure range between 1 mbar(a) to 500 mbar(a). That means the GHS is ideal for applications such as printing, canning, plastics, electronics, packaging, bottling and similar industries.

CUSTOMER BENEFITS

- **High reliability** – Oil-sealed technology offers wear-free, robust operation. Reliable, oversized motors and efficient oil-mist separation ensures durable operation.
- **Best-in-class efficiency** – With the highest performance output per kW input, the GV probably outperforms all other vacuum technologies in its pressure range. State-of-the-art coalescing filters reduce oil consumption, running temperatures and motor power consumption. Thanks to a modulating valve, the capacity of the pump can be matched exactly to the demand.
- **Plug and play installation** – A small footprint and space-saving canopy with lift-out panels offer easy installation and easy maintenance.
- **Silent operation** – The two screw elements rotate at slow speeds, so the GV runs at a sound level as low as 69 dB(A). This silent operation allows you to install the GV close to the point of use.



Model	Maximum shaft power				Pumping speed		Ultimate pressure		Inlet connector	Dimensions (L x W x H)	Weight	
	Air-cooled		Water-cooled		m ³ /h	cfm	mbar (hPa)	torr		mm	kg	lbs
	kW	hp	kW	hp								
50 Hz version												
GHS 630	10.1	13.5	9.8	13.1	557	328	0.7	0.5	DN100	2040 x 1280 x 1480	1070	2355
GHS 1000	20.4	27.4	20.2	27.1	863	508	0.7	0.5	DN100	2040 x 1280 x 1480	1105	2430
GHS 1200	30.8	41.3	30.5	40.9	1126	663	0.7	0.5	DN125	2040 x 1280 x 1480	1105	2430
GHS 1600	41.4	55.5	39.8	53.4	1601	942	0.7	0.5	DN125	2560 x 1710 x 1970	1805	3970
GHS 2500	58.2	78.1	56.5	75.8	2432	1432	0.7	0.5	DN200	2560 x 1710 x 1970	2860	6290
GHS 4800	118.5	159.9	115.8	155.3	4778	2814	0.7	0.5	DN200	2990 x 1990 x 2000	3680	8100
60 Hz version												
GHS 630	11.7	15.7	11.3	15.2	668	393	0.7	0.5	DN100	2040 x 1280 x 1480	1080	2370
GHS 1000	22.1	29.6	21.7	29.1	1036	610	0.7	0.5	DN100	2040 x 1280 x 1480	1115	2450
GHS 1200	37.4	50.1	36.0	48.3	1351	796	0.7	0.5	DN125	2040 x 1280 x 1480	1130	2480
GHS 1600	49.5	66.4	48.6	65.2	1921	1131	0.7	0.5	DN125	2560 x 1710 x 1970	1820	4000
GHS 2500	69.1	92.7	67.5	90.5	2918	1719	0.7	0.5	DN200	2560 x 1710 x 1970	2885	6350
GHS 4800	142.6	191.2	140.3	188.2	5734	3377	0.7	0.5	DN200	2990 x 1990 x 2000	3680	8100

Available accessories & options

		GV 630	GV 1000	GV 1200	GV 1600	GV 2500	GV 4800
Accessories	Liquid separators	○	○	○	○	○	○
	Inlet filters	●	●	●	●	○	○
	Vacuum tank/receivers	○	○	○	○	○	○
	Check valves & pump isolation valves	○	○	○	○	○	○
	Vacuum gauges (various types & ranges)	○	○	○	○	○	○
	Multiple pump controllers	○	○	○	○	○	○
Options	Air-cooled	○	○	○	○	○	○
	Water-cooled	○	○	○	○	○	○
	Phase sequence protection	○	○	○	○	○	○
	Increased water handling capability	○	○	○	○	○	○
	Vacuum oil PG	●	●	●	●	●	●
	Vacuum oil PG plus for extended duty	○	○	○	○	○	○
	Food grade oil	○	○	○	○	○	○

● : Standard

○: Optional

2 stage oil-sealed rotary vane vacuum pumps

GVD 0.7-28, 0.7-27.5 m³/hr, 50 Hz - 0.5-19.5 cfm, 60 Hz

The GVD series of small oil-sealed rotary vane pumps deliver excellent ultimate vacuum pressure, high pumping speeds and superior vapor handling capabilities with quiet operation. With over 200,000 units sold, these pumps offer proven performance that sets the industry standard for R&D and scientific pumping applications. All pumps are approved to UL and CSA standards by an external test house and feature our patented mode selector switch, meaning one model is suitable for both high vacuum or high throughput applications. In summary, you can rest assured that when you choose an Atlas Copco GVD 2 stage oil-sealed rotary vane pump you are choosing a product you can rely on from a company you can trust.

CUSTOMER BENEFITS

- Ultra quiet operation and intrusive frequencies minimized.
- Dual mode. Suitable for high throughput and high vacuum applications.
- Easy-to-use gas ballast.
- Fast acting inlet valve for system protection.
- High torque, dual voltage/dual frequency motor, electronic start relay.
- Efficient high pressure lubrication.
- Oil-tight with printed gaskets, effective shaft seals.
- Clamped-in sight glass.
- Oil box well contains filling spills.
- Hi-tech polymer blades, large diameter, easy-clean oil passages.
- Consistent, built-in quality, cast bar.
- Wide variety of accessories is available.

APPLICATIONS

- Laboratory bench top
- Research and development
- Turbomolecular backing pumps
- Freeze drying
- Analytical instruments



GVD, 50/60 Hz

Pump type	Pumping speed*		Ultimate pressure		Motor power		Overall dimensions			Noise level
			Gas ballast closed		1-ph**		D	W	H	At 50 Hz
	m ³ /hr	cfm	mbar	Torr	50 Hz (W)	60 Hz (W)	mm	mm	mm	dB(A)
GVD 0.7	0.75/0.95	0.4/0.5	3.0 x 10 ⁻³	2.3 x 10 ⁻³	90	90	151	324	178	43
GVD 1.5	1.6/2.0	0.8/1.2	3.0 x 10 ⁻³	2.3 x 10 ⁻³	160	160	151	324	178	54
GVD 3	3.3/3.9	2/2.3	2.0 x 10 ⁻³	1.5 x 10 ⁻³	450	550	170/158**	430	229	48
GVD 5	5.1/6.2	3.0/3.7	2.0 x 10 ⁻³	1.5 x 10 ⁻³	450	550	170/158**	430	229	48
GVD 8	8.5/10	5/5.9	2.0 x 10 ⁻³	1.5 x 10 ⁻³	450	550	180/158**	470/469**	265	48
GVD 12	12/14.2	7.1/8.4	2.0 x 10 ⁻³	1.5 x 10 ⁻³	450	550	180/158**	490/489**	265	48
GVD 18	17/20.4	10/12.1	1.0 x 10 ⁻³	7.5 x 10 ⁻⁴	550	750	183/171**	520	272	57
GVD 28***	27.5/33.0	16.2/19.5	1.0 x 10 ⁻³	7.5 x 10 ⁻⁴	750	900	183/162**	584	272	57

* Pneurop 6602.

** 1-ph/3-ph (3-phase available GVD 3 to 28 inclusive).

*** 3-phase motors are energy-efficient versions.

Oil is hydrocarbon type, viscosity dependent on pump size. Other oil types are available on special request.

All pumps are CSA and UL approved.

World voltages available for both 1-phase and 3-phase pumps. Details can be found on the datasheets.



2 stage oil-sealed rotary vane vacuum pumps

GVD 40-275, 40-275 m³/hr, 50 Hz - 25.9-180 cfm, 60 Hz

The GVD series two stage oil sealed rotary vane vacuum pumps are renowned for their high ultimate vacuum, rapid pumping speeds, quiet operation and ability to handle water vapour. These direct drive rotary vane pumps are inherently compact and vibration free, and with their finger-proof fan and coupling housings they offer excellent operator protection. A comprehensive range of accessories is available to allow use on the widest variety of vacuum applications.

APPLICATIONS

- Refrigeration and air conditioning system evacuation, drying, and backfilling
- Vacuum drying and distillation
- Backing pump for high vacuum applications
- Vacuum metallurgy processes
- Thin film coating technologies
- Freeze drying
- Transformer and cable drying and impregnation, insulating oil treatment plant
- Cryogenic vessel evacuation

CUSTOMER BENEFITS

- Advanced pressurized oil circuit to give effective lubrication even under high gas loads.
- When the pump is switched off, the spring loaded distributor valve provides oil and air suck-back protection.
- Gas ballast control to assist in handling high water vapor loads.
- Industrial roller bearings on drive shaft for ultimate reliability and long, trouble free life.
- Full height oil sight glass for easy checking of oil level and condition.
- Easy change oil filter, with oil filter condition gauge on larger models.
- Central inlet port to allow easy mounting of mechanical booster pump if required.
- Easy to maintain, with convenient service kits and international customer support.
- A wide range of accessories to match your application needs.
- The pumps and accessories can be supplied either as individual components or as fully systemized, factory-tested combinations.



GVD, 50/60 Hz

Pump type	Pumping speed*		Ultimate pressure		Motor power		Overall dimensions			Noise level
			Gas ballast closed		3-ph kW		D	W	H	At 50 Hz
	m ³ /hr	cfm	mbar	Torr	kW	hp	mm	mm	mm	dB(A)
GVD 40	37/44	21.8/25.9	1 x 10 ⁻³	7.7 x 10 ⁻⁴	1.1/1.5	1.5/2	253	665	409	65
GVD 80	74/90	43.6/53	1 x 10 ⁻³	7.7 x 10 ⁻⁴	2.2/3	3/4	274	796	445	70
GVD 175**	160/196	94/115	1 x 10 ⁻³	7.7 x 10 ⁻⁴	5.5/6.5	7.5/8.5	410	994	563	75
GVD 275**	255/306	150/180	1 x 10 ⁻³	7.7 x 10 ⁻⁴	7.5/8.5	10/11	415	1088	565	75

* Pneuop 6602.

** Water-cooled machines.

Oil is hydrocarbon type, viscosity dependent on pump size. Other oil types are available on special request.

All motors are 3-phase energy-efficient.

IEC EN60034.

Available motor voltages:

- 400 V 50 Hz
- 460 V 60 Hz NEMA premium
- 200/380 Hz 50/60 Hz



Vacuum booster pumps

ZRS 250-4200

The ZRS mechanical booster pumps, based on the simple roots principle, remains the favourite pump for applications where high pumping speeds are required for pressures in the region of 0.01 to 50 mbar. This pump must always be backed by another pump, which can deliver against a high-pressure differential to atmospheric pressure. Operating at relatively low pressures, the mechanical booster pump is not exposed to the same concentrations of corrosive process media as is the backing pump, which makes it highly reliable.

APPLICATIONS

- Vacuum packaging
- Drying and de-gassing
- Vacuum metallurgy
- Vacuum distillation
- Thin film coating
- Low density wind tunnels
- Space simulation
- Vacuum impregnation
- Freeze drying

CUSTOMER BENEFITS

- Suitable for applications where high pumping speeds are required in the pressure region of 0.01 to 50 mbar/0.0075 to 37.5 Torr.
- Operating at relatively low pressures makes it highly reliable.
- The ZRS pumps have a high quality, oil-free pumping mechanism. This offers:
 - Quiet, vibration free operation.
 - Rugged and corrosion resistant.
 - Advanced shaft-seal technology with no oil contamination of the process chamber.
- The proven shaft-seal arrangement ensures that no oil enters the pumping stator, and the absence of internal and external by-pass lines and valves which may corrode or stick minimizes maintenance requirements.
- The design of the shaft seals is optimized to ensure that no lubricants can migrate into the pumping mechanism. This maintains booster pump performance in applications which demand the highest standard of cleanliness. In addition, this prevents the build-up of trapped particles on the rotor lobes and end-faces which have very close tolerances.
- The dynamically balanced rotors and precision ground gears contribute to the smooth, quiet operation of the pumps, as demanded by manufacturers of advanced technology equipment.



ZRS, 50/60 Hz

Pump type	Displacement (swept volume)		Maximum pressure differential		Motor power		Overall dimensions			Weight
	m ³ h ⁻¹	cfm	mbar	°Torr	Hydrocarbon		D	W	H	
					kW	Hp	mm	mm	mm	kg
ZRS 250	310/375	185/220	180/150	140/115	2.2	3	705	305	272	69
ZRS 500	505/605	300/335	110/90	83/68	2.2	3	791	305	265	106
ZRS 1200	1195/1435	715/845	90/75	68/56	3	4	952	380	334	149
ZRS 2600	2590/3110	1525/1830	80/67	60/50	11	15	1156	522	498	345
ZRS 4200	4140/4985	2440/2935	60/50	45/38	11	15	1336	522	498	481

Hydrokinetic drive is water-cooled on ZRS 1200 and above.

Motors conform to EN 60034 and are energy efficient.

Voltage options:

- 400 V 50 Hz
- 230/460 V 60 Hz
- 200/380 V 50 Hz
- 200/380 V 60 Hz

Oil is 100cSt hydrocarbon type. Other oil types are available on special request.



Standard liquid ring vacuum pump packages

AWS & AWD

Atlas Copco liquid ring vacuum pumps are offered as standard packages in a number of configurations, suitable for operation in once through, partial or total recirculation. For partial or total re-circulation systems the pump package components are offered with stainless steel wetted parts as standard, irrespective of the materials of construction of the pump. The AW liquid ring vacuum pumps are available for both single (AWS) and two stage pumps (AWD) with capacities from 200-37500 m³/h and vacuum levels down to 30 mbar(a).

APPLICATIONS

Liquid ring vacuum pumps are ideal for specific, humid, dirty and/or large applications in heavy industries, a selection of which can be found below. The AWS and AWD series are the workhorses of the local economy: strong, reliable, proven and simple machines that deliver utility or process vacuum. As part of the Atlas Copco Group, Hick Hargreaves brings more than 50 years of expertise in liquid ring pumps; delivering sustainable productivity in the harshest environments.

CUSTOMER BENEFITS

- Standard package design: 50 Hz DIN or 60 Hz ANSI available.
- Modular design of 3 package types: once through, partial recirculation and total recirculation.
- Optional materials of construction: cast iron, stainless steel fitted, stainless steel complete.
- Accessories have stainless steel wetted parts as standard.
- Short lead times, minimum life cycle costs and optimized reliability.
- Easy design iteration steps without extensive dead time between phases.
- Certified for hazardous area operation (European ATEX Ex II 2Gc, IIBT3, USA Explosion proof Class 1 Division 1 Group C & D).
- Non-hazardous area versions and full range of skid mounted accessories are also available.

- Mining
- Brick extrusion
- Automotive industry
- Cement and allied products
- Chemical industries
- Food processing
- General manufacturing
- Metalwork industries
- Paper and allied products
- Petroleum industries
- Oil and gas
- Plastics
- Textile industry
- Power and utilities



AW liquid ring vacuum pump configurator

The AW liquid ring vacuum pump configurator utilizes 3D AutoCAD design software to produce a tailored liquid ring vacuum pump package constructed from pre-engineered modules. The main benefits being the rapid availability of a customized quotation and package general arrangement drawing as well as reduced lead times for what is essentially bespoke engineered systems. Atlas Copco offers a selection of pump material options along with a choice from three standard operating configurations to suit most process conditions.

ONCE THROUGH

This is the most basic configuration available, it comprises of a pump complete with electric motor, drive and base frame. These systems are ideal where an ample supply of seal liquid is available, which can be subsequently discharged to drain. The liquid/gas mixture is discharged to drain through the discharge line.

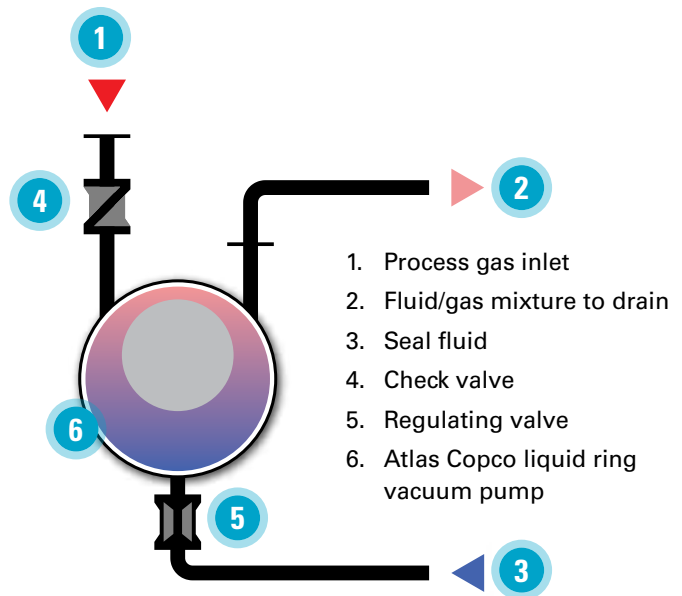

PARTIAL RECIRCULATION

In this case, the liquid/gas mixture is separated in the discharge separator. The recovered service liquid is then mixed with fresh seal fluid to maintain a constant temperature to the pump. The excess liquid, equivalent to the make-up supply, goes to drain. The minimum amount of fresh make-up fluid is used to ensure cavitation free operation at the required suction pressure.

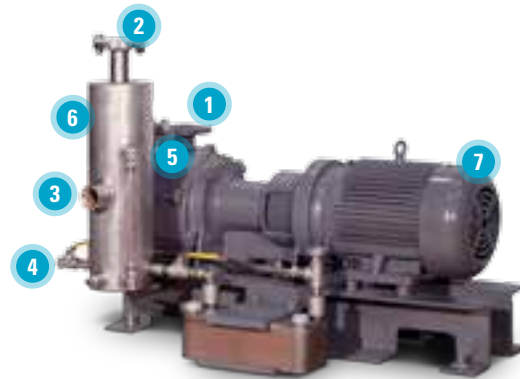
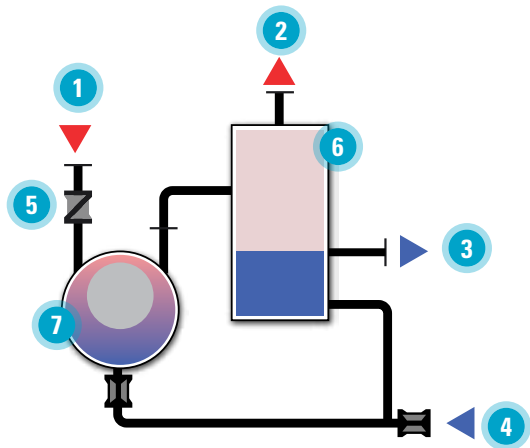

- 1. Inlet connection
- 2. Outlet connection

- 3. Overflow
- 4. Seal fluid make-up valve

- 5. Check valve
- 6. Discharge separator

- 7. Atlas Copco liquid ring vacuum pump

TOTAL RECIRCULATION

Total recirculation is used where a closed loop system is preferable when the seal fluid is in short supply or when contamination may be a problem. To enable total recirculation of the seal liquid, the recovered liquid must be cooled prior to re-use. In this case a heat exchanger is utilized between the discharge separator and the pump.

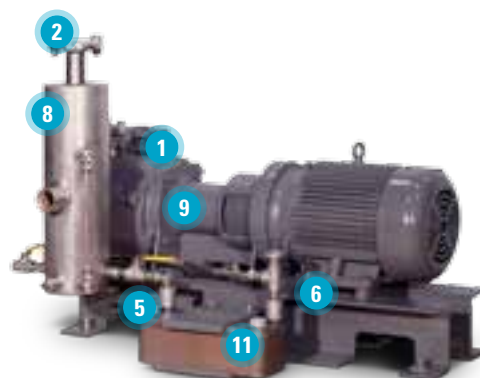
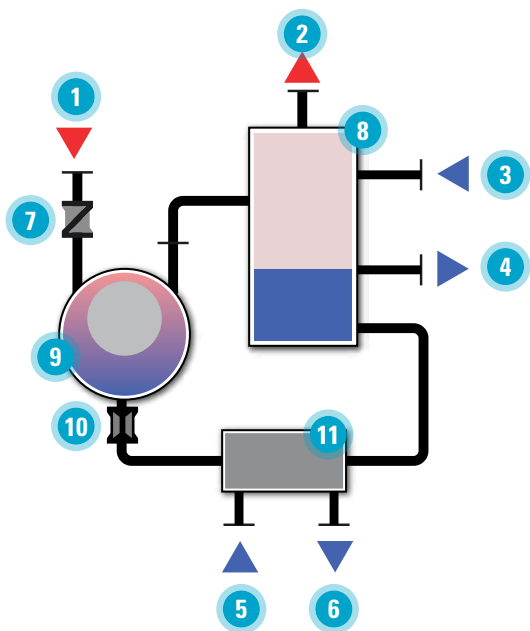

- 1. Process gas inlet
- 2. Gas vent
- 3. Make-up fluid

- 4. Fluid overflow to drain
- 5. Cooling liquid IN
- 6. Cooling liquid OUT

- 7. Check valve
- 8. Discharge separator
- 9. Atlas Copco liquid ring vacuum pump

- 10. Manual control valve
- 11. Heat exchanger

AWD 200-4510 (direct driven)

TYPE	Peak pumping speed		Motor power		Ultimate pressure		Motor speed	Seal fluid recirculation options
			50 Hz	60 Hz			50 Hz	
	m ³ /h (@50 Hz)	cfm (@60 Hz)	kW		mbar(a)	"Hg (vac)	rpm	O/P/T*
AWD 200	200	141	7,5	11	30	29	1450	O/P/T
AWD 400	400	283	15	22	30	29	1450	O/P/T
AWD 610	610	432	22	30	30	29	1450	O/P/T
AWD 1230	1230	869	45	55	30	29	980	O/P/T
AWD 1680	1680	1188	55	75	30	29	980	O/P/T
AWD 1960	1960	1386	75	90	30	29	735	O/P/T
AWD 3280	3280	2316	110	132	30	29	735	O/P/T
AWD 4510	4510	3186	132	150	30	29	735	O/P/T

AWS 3300-37500 (belt driven)**

TYPE	Peak pumping speed		Motor power	Ultimate pressure		Motor speed		Seal fluid recirculation options
			50/60 Hz			50 Hz	60 Hz	
	m ³ /h	cfm	kW	mbar(a)	"Hg (vac)	rpm		O/P/T*
AWS 3300	3300	1940	75	160	25.2	1450	980	P/T
AWS 4500	4500	2650	110	160	25.2	1450	980	P/T
AWS 6000	6000	3530	132	160	25.2	1450	980	P/T
AWS 8500	8500	5000	220	180	24.6	1450	980	P/T
AWS 10500	10500	6180	220	160	25.2	1450	980	P/T
AWS 13800**	12800	8130	300	180	24.6	1450	980	P/T
AWS 17100**	17100	10100	400	180	24.6	1450	980	P/T
AWS 22500**	22500	13250	550	180	24.6	1450	980	P/T
AWS 30000**	30000	17700	560	180	24.6	1450	980	P/T
AWS 37500**	37500	22100	775	180	24.6	1450	980	P/T

* O/P/T: Once through, Partial recirculation, Total recirculation

** Gear box drive option available.

Accessories

- Inlet non-return valve
- Inlet isolating valve
- Inlet vacuum gauge
- Vacuum relief valve
- Automatic seal water make up kit
- Custom built and hybrid vacuum pump systems available

Materials of construction

		Standard	Stainless steel fitted	Stainless steel
Pump	Casing	Cast iron	Cast iron	CF8M
	Impeller	Bronze	CF8M	CF8M
	Port plates	Cast iron	Cast iron	CF8M
	Body	Cast iron	Cast iron	CF8M
	Shaft	420S27	420S39	420S38
	Mechanical seal	Carbon/Silicon Carbide/Viton	Carbon/Silicon Carbide/Viton	Carbon/Silicon Carbide/Viton
Components	Discharge separator	Stainless steel	Stainless steel	Stainless steel
	Piping	Stainless steel	Stainless steel	Stainless steel
	Fittings & valves	Stainless steel	Stainless steel	Stainless steel
	Heat exchanger	Stainless steel	Stainless steel	Stainless steel

* O/P/T: Once through / Partial recirculation / Total recirculation.

** Gear box drive option available.



Download a QR Reader and scan the code for more information on our Vacuum Solutions offerings.

www.atlascopco.com/vacuum

CENTRIFUGAL COMPRESSORS, EXPANDERS AND PUMPS

We bring innovative drive and decades of engineering experience to the industrial equipment we produce. Our compressors, expanders and cryogenic pumps support a wide range of markets and applications across the globe.

Centrifugal Turbomachinery and Cryogenic Pumps

Atlas Copco turbocompressors, expansion turbines and cryogenic pumps are found at the heart of industries that keep the world in motion: oil and gas, industrial gases, and power generation. Our innovative compression and pump designs deliver top performance in an efficient, compact package and ensure decades of reliable use under some of the most demanding conditions.

CENTRIFUGAL AIR AND GAS COMPRESSORS

Atlas Copco centrifugal compressors are built using cutting-edge aerodynamic technology and proven, heavy-duty components. They deliver the high Capacity FAD rates and pressure levels necessary for such important processes as plant air in petrochemical or industrial gas installations.

Utilizing multi-stage compression with as many as eight stages on a single gearbox, our centrifugal gas compressors can be configured to handle combined processes in one cycle – such as processing different gases simultaneously – and they supply the high flow and pressure levels that might otherwise require additional machinery. Our centrifugal gas compressors can handle flow volumes from 250-400 000 m³/h* and generate pressures up to 200 bar, and beyond.

Exclusive impeller design and control options, such as variable inlet- and diffuser-guide vanes, ensure that pressure and flow rates remain constant even as factors such as ambient temperature or back pressure change.

Likewise, when the ability to precisely control gas volume is key – in applications such as fuel gas boosting for gas turbines – our speed controls deliver the crucial large turndown range required.

EXPANSION TURBINES (TURBOEXPANDERS)

Whether used to liquefy natural gas for transport, create cryogenic conditions for air separation, or turn

excess heat into valuable energy, the key to turboexpander performance is thermal efficiency.

Atlas Copco's proven impeller designs help generate superb cooling capacity and make these impellers the most reliable on the market. Specially-developed insulation on the expander casing and at other key areas, along with tailored shaft seals ensure that both the cold temperatures and the gases vital to your process remain within the system.

Our turboexpanders are available in compressor-loaded, integrally-gear generator-loaded, generator-loaded or hydraulic-brake-loaded configurations. In power generation applications, they can deliver up to 25 MW per stage.

ATLAS COPCO JC CARTER® CRYOGENIC PUMPS

Atlas Copco's full line of JC Carter cryogenic pumps cover the complete liquefied natural gas (LNG) and liquefied petroleum gas (LPG) value chain from liquefaction through regasification and play crucial roles in petrochemical plants and refineries.

Backed up by more than 50 years of innovation in the field, the newest line of third-generation Atlas Copco JC Carter cryogenic pumps offers distinct advantages over nearly all other competitive systems sold today.

Thanks to their cutting-edge design, these pumps deliver the industry's smallest in-tank pump column size and the lowest Net Positive Suction Head (NPSH) values.

The increased usable tank storage capacity this affords, along with efficiency levels that are 5-15% greater than the industry average, translates into higher plant revenues.

Our pumps are available in flow ranges of 10 m³/h (5.89 cfm) to 3000 m³/h (1767 cfm) and can be used in a suction pot, mounted in-tank or in a marine/fixed configuration.

**Based on the flow rates in the other portions of this catalogue which are in m³/min, here the rating would be 4.2 - 6666 m³/min, and for the British Imperial System, it would be 147.14 - 235 431 cfm.*



**Centrifugal compressors for gas and air applications, up to 200 bar discharge pressure, driver power up to 40 MW
GT**

Page 182



**Radial inflow expansion turbines (turboexpanders)
EC, ECM**

Page 189



**Centrifugal compressors for air and nitrogen, discharge pressures up to 32 bar
H**

Page 183



**Integrally-g geared expander generators for industrial applications or energy recovery
EG, EG*i*, EEG*i***

Page 190



**Direct-driven centrifugal turbocompressors for polyethylene and polypropylene
T**

Page 184



**Low pressure cryogenic vertical turbine pumps
TA & TX**

Page 191



**Centrifugal compressors for air and gas applications, up to 70 bar
SC**

Page 185



**Cryogenic process radial diffuser pumps
RD**

Page 193



**Integrally-g geared centrifugal compressor for gas and air, up to 70 bar
TP**

Page 186



**Cryogenic high-pressure continuous crossover pumps
CC**

Page 192



**Integrally-g geared Turbo- expanders for air applications, up to 4 MW / 160 bar
ETB, ETG, ETF**

Page 188

Centrifugal compressors for gas and air applications, up to 200 bar discharge pressure, driver power up to 40 MW GT

Driven by Integral Gear technology, Atlas Copco's GT Series provides maximum compressor efficiency and reliability. This ensures sustainable productivity in processes across dozens of industries and applications. Our GT compressors are at work in the steel mills of China to complex oil and gas operations on the world's Seven Seas – and beyond. The GT Series handles flow volumes up to 400 000 m³/h (235 431 cfm), in configurations up to eight stages. It handles all gases.

CUSTOMER BENEFITS

- **Customization** – From impeller design to packaging options and diffuser, GT Series compressors provide a vast range of customization options to meet customer requirements and improve your process.
- **Regulatory compliance** – The GT Series is manufactured according to the rigorous standards of the American Petroleum Institute (API), namely API 614, Chapter 3 (gas); oil systems according to API 614.
- **Small footprint** – The compact package design reduces the compressor's footprint.
- **Maximum reliability** – This is a crucial aspect particularly in the air separation industry and oil & gas applications (marine and offshore).
- **Maximum compressor efficiency** – Focusing on power optimization of your process.

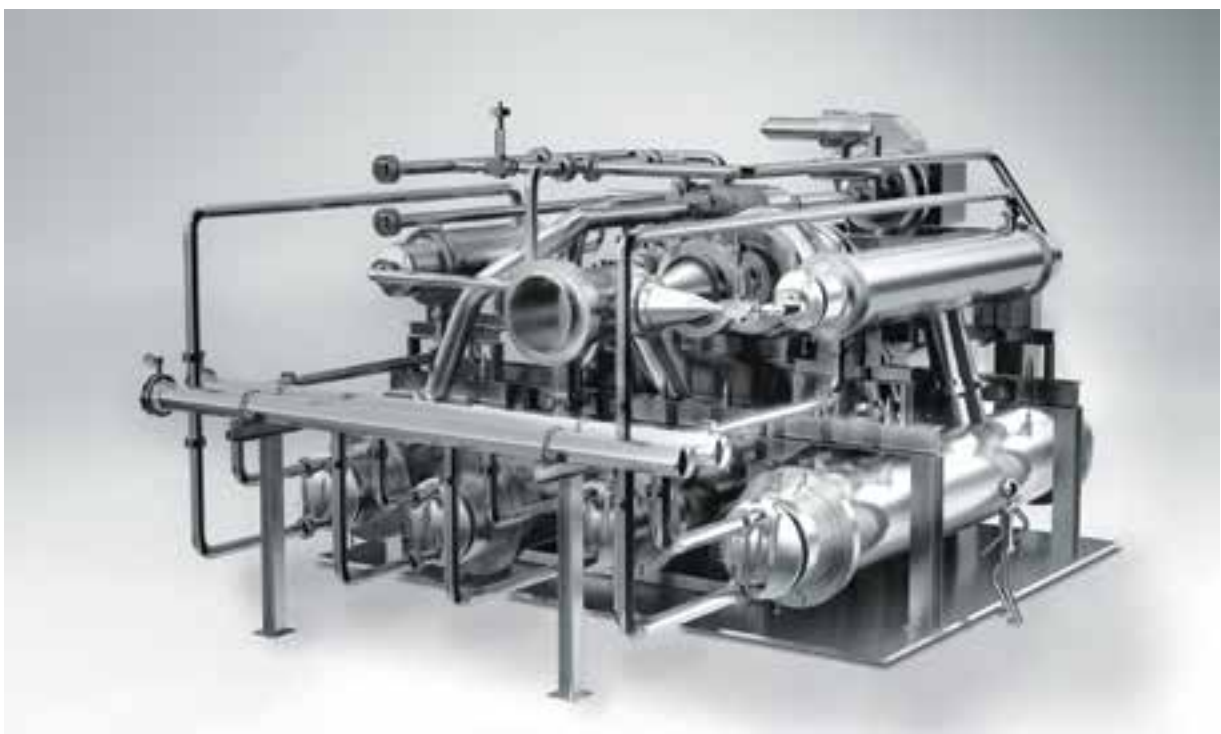

Centrifugal compressors for air and nitrogen, discharge pressures up to 32 bar

H

The H-Series centrifugal compressor marks the culmination of more than 100 years of Atlas Copco experience in air compression. Anchored in innovative engineering and manufacturing techniques, this compressor combines premier technology for the delivery of oil-free compressed air. The H Series serves the requirements of many industries, including: air separation, chemical, petrochemical, process air, etc. It is widely known and accepted as an efficient, dependable and cost-effective compressor solution that comes as a standard package but also fully engineered to API specifications. The H Series handles flow volumes up to about 50 000 m³/h (29 429 cfm) in multi-stage configurations and 85 000 m³/h (50 029 cfm) for single-stage compressors.

CUSTOMER BENEFITS

- **Optimized performance** – Quality-engineered components optimize the performance and reliability of your process.
- **Maximum efficiency** thanks to exclusive H Series impeller design.
- **Customer-driven product** that fully meets your requirements in a broad range of industries and applications.
- **Energy savings** due to deployment of adjustable inlet guide vanes.
- **Localized packaging options.**



Direct-driven centrifugal turbocompressors for polyethylene and polypropylene

T

Drawing from Atlas Copco's extensive experience in complex applications, the T Series compressor is used in some of the most challenging processes. For more than two decades the T-Series compressor has been at the heart of demanding, high-profile downstream petrochemical applications worldwide, from Russia to the Middle East, and beyond. The T Series handles discharge pressures up to 40 bar (580.2 psi) and flow volumes up to 50 000 m³/h (29 450 cfm).

CUSTOMER BENEFITS

- **Maximum compressor efficiency and reliability.**
- **Superior efficiency** thanks to the unique design and position of the inlet guide vanes in connection with the closed impeller.
- **Regulatory compliance** – The T Series is manufactured according to the rigorous standards of the American Petroleum Institute (API), namely API 617, Chapter 3 (gas); oil systems according to API 614.



Centrifugal compressors for air and gas applications, up to 70 bar SC

Featuring integral gear technology at the heart of the machine, the SC Series compressor offers reliable and efficient service across dozens of applications in air separation as well as in the gas and process industries. The SC Series is a reliable, cost-effective compressor solution and ensures that customers have sustainable productivity in their process. The SC Series handles flow volumes up to 110 000 m³/h (64 544 cfm) at suction temperatures ranging from -40 °C/-40 °F to 200 °C/392 °F. It handles all gases.

CUSTOMER BENEFITS

- **Easy installation** – Compact packaging design reduces installation costs and footprint.
- **High efficiency** – Power savings in all operation modes and superior turndown rates result in maximum efficiency.
- **Regulatory compliance** – The SC Series is manufactured according to the rigorous standards of the American Petroleum Institute (API), namely API 617, Chapter 3 (gas); oil systems according to API 614.

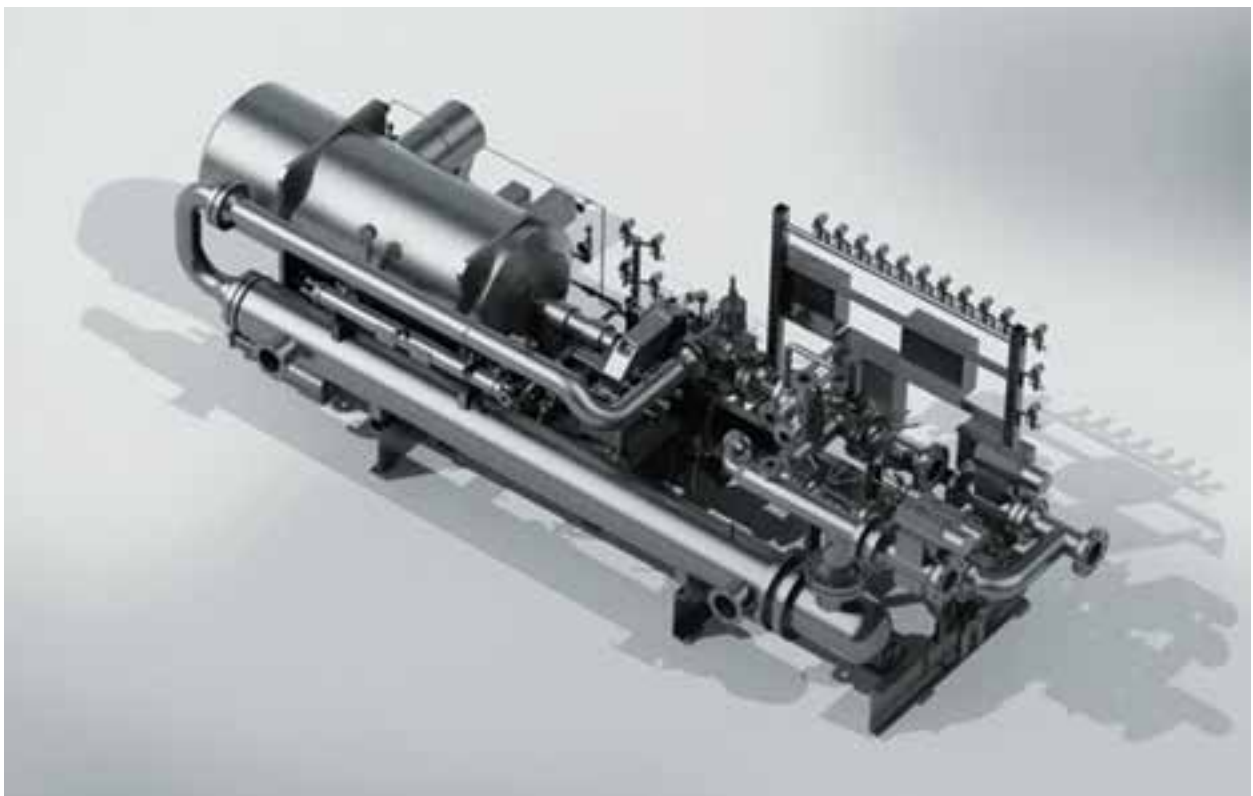

Integrally-gearred centrifugal compressor for gas and air, up to 70 bar

TP

Driven by integral gear technology, Atlas Copco's TP centrifugal gas compressor offers maximum reliability and efficiency for dozens of air and gas applications. It provides cost-effective, sustainable service in facilities all over the world. TP Series compressors are known for their dependable and innovative service, as well as their adherence to API specifications. The TP Series handles flow volumes up to 20 000 m³/h (11 772 cfm) at suction temperatures ranging from -40 °C/-40 °F to 200 °C/392 °F. It handles all gases.

CUSTOMER BENEFITS

- **Small footprint** – Installation costs and occupied floor space are reduced by a compact packaging design.
- **Maximum efficiency impeller design.**
- **Customizable** – Option to use a custom combination of standardized components.
- **Flexibility** – Adjustable inlet guide vanes offer a wide operating range and excellent partial load performance.



Features of Turbocompressor Products

Features	GT	H	T	SC	TP
Suction pressure (max.)	80 bar(a)	1.4 bar(a) (8 bar)*	40 bar(a)	70 bar(a)	50 bar(a)
	1160.3 psia	20.3 psia	580.2 psia	1015.3 psia	725.2 psia
Discharge pressure (max.)	200 bar(a)	32 bar(a)	40 bar(a)	70 bar(a)	70 bar(a)
	2900.8 psia	446.1 psia	580.2 psia	1015.3 psia	1015.3 psia
Suction temperature	-200 to 200 °C	-40 to 50 °C	-40 to 150 °C	-40 to 200 °C	-40 to 200 °C
	-328 to 392 °F	-20.2 to 122 °F	-40 to 302 °F	-40 to 392 °F	-40 to 392 °F
Effective inlet-flow range	250 to 400000 m ³ /h	3500 to 50000 (85000**) m ³ /h	15000 to 50000 m ³ /h	250 to 110000 m ³ /h	250 to 20000 m ³ /h
	147.1 to 235431 cfm	2060 to 29428.5 cfm	8828.7 to 29429 cfm	147.1 to 64744 cfm	147.1 to 11780 cfm
Maximum No. of stages	1 - 8	1 - 6	1	1	2 - 5
Gases handled	All gases	Air, nitrogen	Polyethylene, polypropylene	All gases	All gases
Impeller types	Open / closed	Open	Open	Open	Open
Shaft / impeller connection	Hirth serration	Microspline	Hirth serration	Microspline	Microspline
Seals					
Labyrinth	•	•		•	•
Carbon ring	•	•		•	•
Dry-gas seal	•		•	•	•
Capacity / pressure control					
Variable inlet-guide vanes (IGV)	•	•	•	•	•
Variable diffuser-guide vanes (DGV)	•	•		•	
Variable speed	•		•	•	•
Inlet throttle	•	•		•	•
API	672 / 617	672	617	672 / 617	672 / 617
Axial thrust compensation	High-speed axial bearings or thrust collar	High-speed axial bearings	High-speed axial bearings	High-speed axial bearings	High-speed axial bearings
Oil system	Manufacturer's standard or API 614	Manufacturer's standard or API 614	API 614	Manufacturer's standard or API 614	Manufacturer's standard or API 614
Coupling	Dry	Dry	Dry	Dry	Dry
Test code	VDI2045 / ASME PTC10	VDI2045 / ASME PTC10	VDI2045 / ASME PTC10	VDI2045 / ASME PTC10	VDI2045 / ASME PTC10

* H-booster on request

** single-stage compressors

Integrally-g geared turbo expanders for air applications, up to 4 MW / 160 bar

ETB, ETG, ETF

Atlas Copco's turboexpander solutions for the air separation market ensure smooth process operations in applications such as cryogenic expansion, steel and electronics. They maximize cold power in plants, while at the same time providing simple installation, operation and maintenance. Atlas Copco also provides compressors for air separation plants, to give you a complete portfolio of solutions in this market.

CUSTOMER BENEFITS

- Customized solutions.
- Maximum efficiency.
- Minimized energy consumption.
- Superior cooling capacity in cryogenic processes.
- Robust construction.
- Proven impeller design to precisely meet customer needs.
- Wide operational range.
- Maximum reliability in turboexpander performance.



Features	ETB, ETG, ETF Series	
Suction pressure (max.)	160 bar(a)	2320.6 psia
Suction temperature	-220 to 510 °C	-364 to 950 °F
Maximum No. of stages	1 - 4	1 - 4
Gases handled	All industrial gases and hydrocarbon gas mixtures, including condensing streams	

Radial inflow expansion turbines (Turboexpanders)

EC, ECM

Atlas Copco's turboexpanders convert the internal energy available in a gas stream into useful work by lowering its pressure, thereby producing cooling and shaft power. Turbo expanders are used to produce refrigeration or recover power at petrochemical hydrocarbon processing plants. They typically drive a single-stage, centrifugal compressor, with both the expander and compressor optimized for the process duty. These custom-engineered expander compressors are designed and manufactured to ensure the highest reliability and quality to meet your specific specifications. Incorporating the latest technology, their aerodynamic designs maximize machinery performance without sacrificing dependability. Hydrocarbon applications include LPG, NGL, DPC, LNG and nitrogen rejection. Chemical/ petrochemical applications include ethylene olefin recovery, ammonia purification, carbon monoxide purification, propane ehydrogenation, and hydrogen recovery.

CUSTOMER BENEFITS

- **Custom-engineered solutions** – Expander compressors are designed specifically to customer specifications and unique process requirements.
- **Ultra-high efficiency** – Turboexpanders provide high efficiency refrigeration or power recovery.
- **Robust construction** – Expander compressors are designed for offshore/onshore, outdoor unprotected and attended or unattended sites. They are custom designed for desert, tropical and ambient temperatures as well as hazardous areas (Division 1/Zone 1, Division 2/Zone 2).
- **Highest quality design and production systems** – ISO 19001, 14001 and 18001 quality certification, all machines meet or exceed industry (API 617, API 614, API 670 and ANSI B31.3) and international standards (IEC, NEC, ASME, BS5500).
- **Long-lasting reliable performance** – Many of our expander compressors are in service for over 20 years without a shutdown.



Features	EC, ECM	
Suction pressure (max.)	200 bar(a)	2900.8 psia
Suction temperature	-220 to 200 °C	-364 to 392 °F
Maximum No. of stages	1	1
Gases handled	All industrial gases and hydrocarbon gas mixtures, including condensing streams	

Integrally-gear expander generators for industrial applications or energy recovery

EG, EG*i*, EEG*i*

Whether you want to produce electricity as a by-product of an industrial process, from a geothermal resource, from waste heat, or recover power in a pressure letdown application, Atlas Copco's expander generators are a reliable solution for energy recovery and electrical power production. Utilizing the Organic Rankine Cycle (ORC), typical energy recovery applications include geothermal, waste heat recovery, pressure letdown and cold energy recovery. The speed reduction gearbox features a parallel shaft and integral gearbox. Driven by our integral gear expertise, the expander generators can be configured with one to four stages on a single gearbox to achieve the lowest cost per kilowatt power-train solution. Atlas Copco provides partial or complete solutions, from the core expander to the complete system.

CUSTOMER BENEFITS

- **Built to last** – Their robust construction can withstand rough treatment over a long lifetime of operation in the harshest of work environments.
- **Reliability Centered Maintenance (RCM)** – Maintenance system based on statistical data and experience.
- **High power output** – Power generating ranges up to 25 MW per expander stages.
- **Unique design** – Single or multi-stage turbine design mounted on the same integral gearbox.
- **High efficiency** – Maximum energy recovery efficiency and plant availability.
- **Complete solution** – Partnerships with expert companies for complete cycle design/complete recover solutions.
- **Highest quality design and production systems** – ISO 19001, 14001 and 18001 quality certification, all machines meet or exceed industry (API 617, API 614, API 670 and ANSI B31.3) and international standards (IEC, NEC, ASME, BS5500).



Features	EG, EG <i>i</i> , EEG <i>i</i>	
Suction pressure (max.)	200 bar(a)	2900.8 psia
Suction temperature	-220 to 300 °C	-364 to 572 °F
Maximum No. of stages	1 - 4	1 - 4
Gases handled	All industrial gases and hydrocarbon gas mixtures, including condensing streams	

Low pressure cryogenic vertical turbine pumps

TA & TX

Atlas Copco JC Carter® Type TA and TX Vertical Turbine Pumps are equipped with Atlas Copco's patented HyPerInducer®, which offers the lowest Net Positive Suction Head (NPSH) in the industry. This alone increases the active volume of the storage tanks, creating more accessible inventory. The use of vertical turbine bowl diffusers completely eliminates rotating stalls and improves pump efficiency by up to 88%. Multi-stage designs are created by adding a greater amount of control to each set speed. This allows for lower tip speeds and less rotating mass. Type TA and TX turbines handle flow levels up to 3000 m³/hr and fluid temperatures ranging from -196 °C/-320 °F to 45 °C/ 113 °F.

CUSTOMER BENEFITS

- **High efficiency levels** – Up to 88% efficiency.
- **Hydraulic designs with higher specific speeds**, resulting in higher efficiency.
- **Easy maintenance.**
- **Dependable** - An active thrust balance system for increased bearing life



Features	Type TA & TX	
Size	Up to 800+ kW	Up to 800+ kW
Flow	Up to 3000 m ³ /hr	1766 cfm
Head	Up to 350 m	Up to 1148 ft
Fluid Temp.	-196 °C to 45 °C	-320 to 113 °F
Pump Ns (specific speed)	1250 to 3200	1250 to 3200
Motor	Submersible, 50 & 60 Hz designs, variable frequency drive (VFD), up to 6600 volts	
Fluids handled	LNG, butane, nitrogen, propylene, ethane, neon, hexane, propane, ethylene, butane, butadiene, VCM	

Cryogenic high pressure continuous crossover pumps CC

Offering up to 89% efficiency, high-pressure Type CC pumps from Atlas Copco JC Carter® are among the most efficient on the market.

Because continuous-crossover pumps might represent as much as 60% of an LNG terminal's total electric power consumption, boosting these pumps' efficiency can significantly cut costs. Equipped with multi-stage continuous crossover diffusers, Type CC pumps feature constant head rise to shut-off.

Reliability is an additional hallmark of our Type CC pumps. The active thrust balance system increases bearing life, and a robust rotor shaft allows for easy maintenance. Type CC pumps provide flow volumes of up to 600 m³/hr for fluids with temperatures ranging from -196 °C/-320 °F to 45 °C/113 °F.

CUSTOMER BENEFITS

- **High efficiency** – Higher specific speed hydraulic design.
- **Easy maintenance.**
- **Handles high vapor fractions**, with Atlas Copco's patented HyPerInducer®.
- **Constant diameter pump shaft** ensures dimensional stability when combined with close coupled stage/designs.
- **Saves money** on LNG terminal power bills.



Features	Versatile Pump Handling Multiple Applications	
Size	Up to 3000+ kW	Up to 3000+ kW
Flow	Up to 600 m ³ /hr	Up to 353 cfm
Head	Up to 3000 m	Up to 9842 ft.
Fluid Temp.	-196 °C to 45 °C	-320 to 113 °F
Pump Ns (specific speed)	1250, 1600	1250, 1600
Motor	50 & 60 Hz designs, variable speed, up to 6600 volts variable frequency drive (VFD), up to 6600 volts	
Fluids handled	LNG, butane, nitrogen, propylene, ethane, neon, hexane, propane, ethylene, butane, butadiene, VCM	

Cryogenic process radial diffuser pumps

RD Multiple Application

Atlas Copco JC Carter® radial diffuser process pumps are able to handle a variety of different applications, including the transfer of hydrocarbon liquids.

These versatile pumps are used in liquefaction and at petrochemical plants, refineries, and terminals. They can be configured in a multitude of ways, including pot-mounted, in-tank, and fixed applications. When combined with close-coupled stage designs, the large diameter of the pump shaft ensures dimensional stability and, ultimately, peace of mind.

The pump's robust rotor shaft allows for easy maintenance and is equipped with multi-stage continuous crossover diffusers for increased efficiency and constant head rise to shut-off. Our radial diffuser pump provides flow volumes to 200 m³/hr for fluids with temperatures ranging from -196 °C/-320 °F to 45 °C/113 °F.

CUSTOMER BENEFITS

- **High versatility** – Can be used in a number of different plants and terminals.
- **Easy maintenance.**
- **Handles high vapor fractions** with Atlas Copco's patented HyPerInducer®.
- **Dependable** – Can be paired with close coupled stage/designs.



Features	Versatile Pump Handling Multiple Applications	
Size	Up to 200 kW	Up to 200 kW
Flow	Up to 200 m ³ /hr	Up to 117.7 cfm
Head	Up to 700 m	Up to 2296 ft.
Fluid Temp.	-196 °C to 45 °C	-320 to 113 °F
Pump Ns (specific speed)	800, 1000	800, 1000
Motor	Low voltage, 50 & 60 Hz or variable speed	
Fluids handled	LNG, butane, nitrogen, propylene, ethane, neon, hexane, propane, ethylene, butane, butadiene, VCM	

TOTAL CUSTOMER CARE

Our organization and people are committed to the maximum operational availability and efficiency of your compressed air network.

Total customer care

Your bottom line, maximum availability of our equipment at minimum total operating cost, is the top priority for all of us at Atlas Copco. Our way of achieving that builds on interaction, on long-term relationships and involvement in your processes, needs and objectives.

Total customer care is our goal at any level of service interaction with you; from standardized genuine parts over tailor-made service plans to remote monitoring and optimization.

We want you to see Atlas Copco as a real performance partner that can contribute to the productivity of your processes. The best way of taking care of your interest is by taking the best care of your equipment.



SAVE ENERGY

Page 196 - 198



MONITOR YOUR PRODUCTS

Page 199 - 201



CUSTOMER SUPPORT PLANS

Page 202 - 205



UPGRADE YOUR PRODUCT

Page 206 - 207



GENUINE PARTS

Page 208 - 216



AIR DISTRIBUTION

Page 217

Download a QR Reader and scan the code for:
"Atlas Copco Service solutions to optimize the Compressor room"



Save energy

Compressed air is one of the most important utilities in the industry. It is also one of the largest consumers of energy.

With their detailed and extensive knowledge of compressed air, our energy and air consultant engineers will be able to determine an acceptable operating balance, that is both within the capabilities of your compressors and also adequate to satisfy your production with minimized operational running costs.

MAXIMIZE THE PERFORMANCE OF YOUR COMPRESSOR

Based on an audit of your production processes Atlas Copco consultants can suggest a more performing set-up for your compressed air installation, with an eye on maximum availability at lowest possible cost.

ATLAS COPCO LOGICAL SEQUENCE TOWARDS SUSTAINABLE ENERGY SAVINGS:

- 1. Pre-assessment**
to estimate savings potentials
- 2. AIRScan energy assessments/audits**
to identify savings potentials through measurement and simulations
- 3. Recommendations**
to prepare your system for the optimization by exchanging the latest, most efficient components
- 4. Optimize**
to achieve the savings by implementation of energy saving accessories and solutions
- 5. Online monitoring**
to ensure the solution implemented is delivering the savings as prescribed
- 6. Regular AIRScan energy assessments/audits**
to validate after the improvements and find further saving potentials

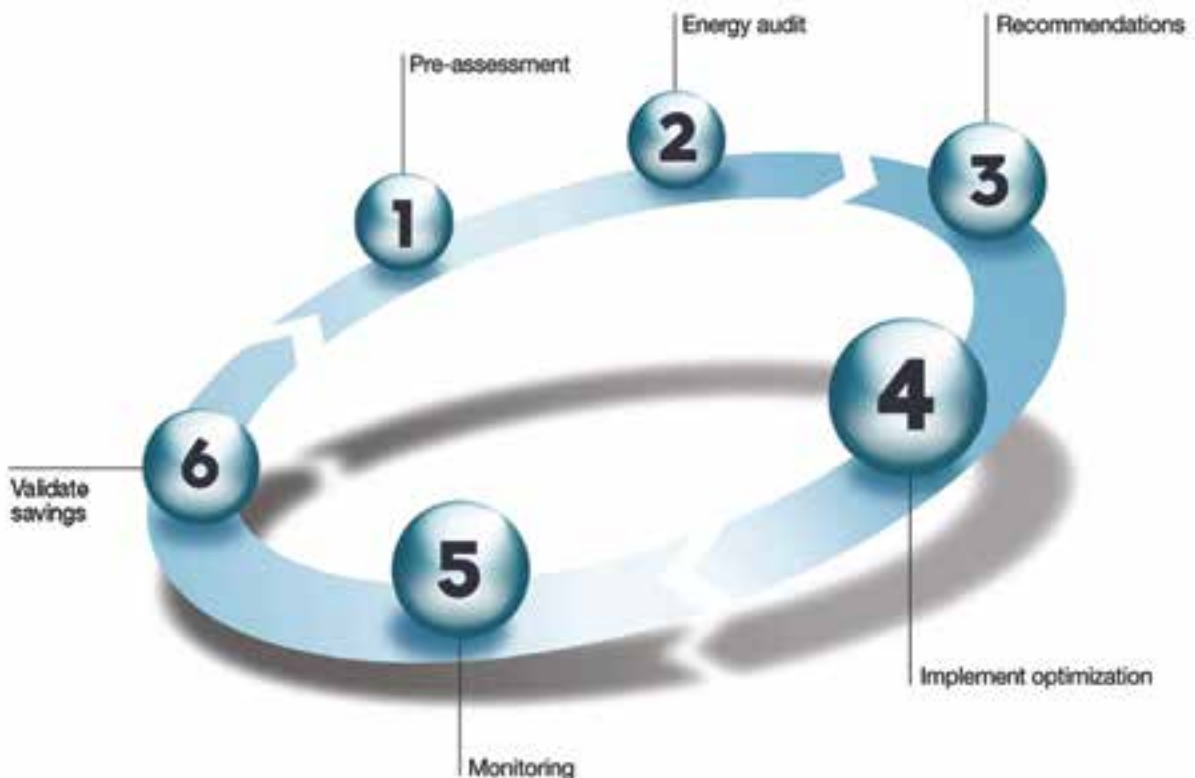

AIRScan

Tangible information for real solutions

A clear understanding of the changing demands over time is a corner stone in any process of system optimization. Defining the limitations of your current compressed air system is the key to finding the best solution to achieving energy efficiency for your business.

UNDERSTANDING YOUR COMPRESSED AIR SYSTEMS

A thorough survey of the compressed air system dynamics, including logging and analysing all the air net key parameters allows you to determine the right operating balance and to identify the energy savings potentials.

Using the logged information, our compressed air experts will provide a comprehensive and fully detailed report, including cost analysis, graphs and the



starting points towards improving the compressed air system. At the end of the survey you will have a valuable document stating the “real status” of your system’s performance, including recommendations to finally achieve sustainable energy savings.

Air optimization

Reduce your energy consumption

Efficient compressor management is the fastest way to achieve energy savings. Each 1 bar (14.5 psi) reduction in working pressure results in 7% direct energy savings and further 3% is saved through leak reduction. Our range of ES Central Controllers will enable you to link all compressors and dryers, lower your overall pressure band, eliminate the need for higher working pressure and optimize the compressor mix at all times.

USING ADVANCED CONTROL SYSTEMS, YOU CAN MAXIMIZE ENERGY SAVINGS BY:

- Regulating the system pressure within a pre defined and narrow pressure band.
- Scheduling shutdown to avoid costs during non production hours.
- Equalizing workload to avoid overloads on individual machines.
- Reducing maintenance costs thanks to comprehensive, flexible machine sequence control.
- The result is a properly managed compressed air system that can save energy, reduce maintenance cost and increase uptime.

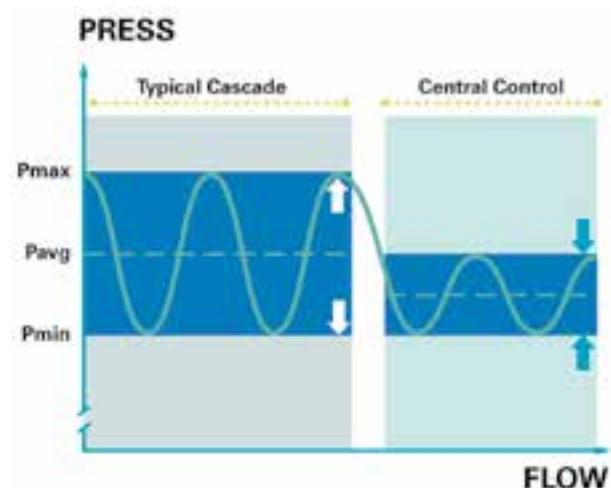



Heat recovery system

By recovering rejected heat and reusing it in your production cycle, allows you to further improve the overall efficiency of any compressed air system and to reduce your plant's total energy consumption.

Through the compression process, part of the energy is lost as radiation. Atlas Copco's Energy Recovery unit is able to extract an amount of energy from compressed air that is equivalent to the amount of energy that the electric motor uses.

The most common uses for the recovered energy include process heating, space heating and water heating.



Monitor your products

Keeping an eye on your equipment at all times is the best way for Atlas Copco to prevent production loss due to a breakdown. This inside view on your operation allows us to plan for maintenance pro-actively.

Compressed air plays a vital part in almost all modern manufacturing processes. In today's competitive production environments, being able to reduce costs, increase efficiency and guarantee maximum uptime is high on everyone's priority list.



SMARTLINK

SMARTLINK is an easy to install, efficient to monitor, easy tailored compressor monitoring program. It offers your company a complete insight of your compressed air production. It helps to predict potential problems (and thus anticipate them); it shows how and where the production can be optimized and energy can be saved.

SMARTLINK is as flexible and informative as you want it to be. Choose from the 3 levels which solution best fits your company.

SMARTLINK Service: Rule out all uncertainties. With SMARTLINK Service installed on your compressors, scheduling maintenance visits becomes as simple and easy as it should be; your service log book is always just one click away and your online link with Atlas Copco allows you to request and receive quotes for spare parts or additional services very fast.

SMARTLINK Uptime: Keep your compressors up and running. By e-mail and/or text, you receive all relevant machine indications (warnings and shutdowns) in advance. Based on this information, you can then take all necessary actions and measures to avoid the risk of a breakdown.



SMARTLINK Energy: Safeguard the performance of your equipment. With SMARTLINK Energy, Atlas Copco enables you to continuously monitor and analyze the energy efficiency of your compressor room. You decide on the performance indicators, you define the benchmarks. SMARTLINK analyzes and reports. You can make accurate and immediate improvements when needed. The results can be used for energy monitoring according to ISO50001



VISUALIZATION

Knowing exactly how your system is running makes identifying ways for improvement much easier. The Atlas Copco monitoring products provide you with the transparency you need to assess system performance. Based on this analysis you can then easily determine a course of action to improve system usage and limit energy consumption costs.



CUSTOMER BENEFITS

- Increased transparency through consolidation of all data.
- Logging & trending to establish the exact performance of your system.
- Real-time display of machine values and statuses directly on your screen.

Gateways Monitor and control through field Bus Connections. Atlas Copco Elektronicon compressor controllers and ES central controllers can be integrated into your existing plant monitoring and control systems, based on the most popular field bus connections Modbus and Profibus.

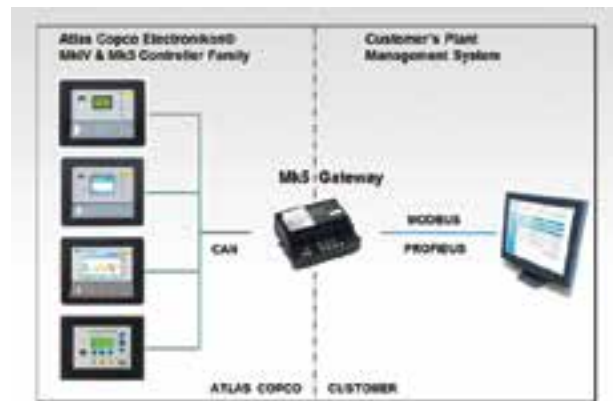

SUPERVISION

Having the same interests at heart, Atlas Copco's ultimate goal is to provide you with the hassle-free compressed air to run your business.

CUSTOMER BENEFITS

- No need for frequent machine checks, saving you time and money.
- Realize maximum uptime and reliability, supported by the Atlas Copco service organization.
- A perfect complement to the Atlas Copco Service Plan, reducing your total cost of ownership.

With maximum uptime and reliability being highly important elements in your everyday production workflow, continuous surveillance is a top priority. With Supervision, Atlas Copco handles the event notifications and provides the immediate response necessary, supported by a response time guarantee.



Customer support plans

What you need is a solution to keep your production optimal at all time and preferably at the lowest operating cost. Our specialized advisors will visit your production facilities and assess your specific needs. This allows us to propose the most cost effective Customer Support Plan for your maintenance needs.

WAYS TO EASE YOUR MIND:

- **We leave it in your hands**

We deliver the necessary spare parts and leave the actual maintenance up to you. We check your compressed air system regularly and identify the necessary actions. The output of each inspection is a complete diagnostic report.

- **We give you a hand:**

We service your compressed air system at pre-determined intervals to lower the risk of unexpected problems and keep your production process optimal at all times. The routine maintenance costs are fixed, which allows you to easily forecast them.

- **You hand it to us:**

We service your compressed air installation following a complete maintenance system that covers all breakdowns. Your equipment will be kept in prime condition at any time and the annual costs for the



agreed period are fixed. This includes all the required parts, labour and travel expenses. There are no hidden surprises. You have total peace of mind.

We leave it in your hands Parts-Only Preventive Maintenance Plan

This Plan covers all parts required to service your Atlas Copco machine as per the recommendations found in the instruction manual. Parts are delivered to you at the correct intervals and in a pro-active manner.

CUSTOMER BENEFITS

- Improved equipment reliability thanks to the genuine Atlas Copco parts and lubricants
- Timely delivery of all required service kits reducing your administration
- Guaranteed parts availability allowing you to eliminate expensive stock



We give you a hand

Service at predetermined intervals

PREVENTATIVE MAINTENANCE PLAN

This Plan covers all regular maintenance for your compressed air equipment in a proactive manner. Certified and trained Atlas Copco service technicians use genuine parts and lubricants to maintain your installation as it should be. This is the best way to lower the risk of unexpected problems allowing you to optimize your production process. The plan can be customized and adjusted at any time



CUSTOMER BENEFITS

- Improved equipment reliability thanks to genuine parts and expert technicians
- Stable costs up front helping you balance your maintenance budget
- Eliminate stock and administration by letting the experts take care of it

INSPECTION PLAN

A compressed air system can only be managed efficiently if the right data is available. Atlas Copco's Inspection Plan consists of regular inspection visits to identify any actions required to keep your compressed air system in prime operating condition. The output of the Inspection Plan is a complete diagnostic report, from which any work related to subsequent improvements can be quoted separately, allowing you to follow separate approval flows.



CUSTOMER BENEFITS

- No surprises, fixed yearly fee to perform the inspections including all labour and travel costs
- Improved equipment reliability thanks to regular follow-ups by the experts
- Comprehensive diagnostic report after each inspection visit

FIXED PRICE SERVICES FOR REGULAR MAINTENANCE

From machine inspections to labour intensive recommended visits, Fixed Price Services offer you a clear path to maintaining your compressed air installation. Atlas Copco's trained technicians arrive at your door with all required parts to get the job done. They ensure that your machine runs in it's most efficient way, with lower energy consumption and less risk of unexpected costs due to failures.



CUSTOMER BENEFITS

- No surprises, one fixed price to perform the work including all travel, material and labour costs
- All manufacturer recommended service activity list done and comprehensive diagnostics report after each visit
- Reduce administration and inventory by letting Atlas Copco take care of it

FIXED PRICE SERVICES FOR OVERHAUL

As the owner of Atlas Copco equipment, you are already familiar with its unique design features that help to achieve high reliability and the lowest total cost of ownership. Overhaul performed after years of equipment operation helps to keep initial reliability and efficiency. Atlas Copco's trained technicians arrive at your door with all required parts to get the job done, and leave you knowing that your machine is in nearly brand new condition



CUSTOMER BENEFITS

- All manufacturer recommended service activity list to keep reliability and efficiency as from day one
- Competent Atlas Copco technicians to perform such a crucial work
- No surprises, one fixed price to perform the overhaul to avoid subsequent downtime and production lost

You hand it to us

Complete maintenance system

TOTAL RESPONSIBILITY PLAN

This Plan lives up to its name – total peace-of-mind with full coverage of the unit including: air ends, motor, electrical and electronic systems, coolers. The program consists of certified Atlas Copco technicians providing you with all regular maintenance, engineering improvements, breakdown repairs and machine overhauls . It is a complete maintenance system with fixed annual costs for the agreed period.



CUSTOMER BENEFITS

- Use of genuine parts and expert technicians for complete coverage including overhauls and unfortunate breakdowns
- Stable costs removing all surprises as you balance your maintenance budget
- Eliminate stock and administration by letting the experts take care of it

AIRXtend

Atlas Copco's AIRXtend program is a five year protection plan to maintain your system with fixed annual costs. This warranty extension is supported by the use of certified Atlas Copco technicians to perform all preventative maintenance for your system at the correct interval and in a proactive manner. Relax knowing that only the highest quality spare parts and consumables are used, originating from the same factories as your equipment.



CUSTOMER BENEFITS

- Use of genuine parts and expert technicians extending your warranty to five years
- Stable costs up front helping you balance your maintenance budget
- Eliminate stock and administration by letting the experts take care of it

Upgrade your product

Our upgrade kits are the result of continuous engineering work to make the latest technology available for your existing equipment range. This will inevitably improve the key performance features such as energy consumption and reliability. Intelligent use and the sustained health of core parts are the basic requirements for the lifelong optimum availability of your equipment.

Upgrade programs Make use of the latest technology

Upgrades take advantage of the most recent computer technology and of the progress in sophisticated compressor control software.

These upgrades increase the reliability and availability of your equipment. Furthermore, upgrading your compressor system will result in substantial energy

savings, while the cost will in most cases be equivalent to or even less than a replacement of older control systems.

CUSTOMER BENEFITS

- **Optimized performance**

With the portfolio of upgrades your machines will be equipped with the latest available options, allowing you to make substantial energy savings.

- **Enhanced reliability**

Upgrade kits focus on reliable performance of critical components and increased reliability will allow your equipment to reach a longer lifetime.

- **Increased availability**

With upgrades, availability is increased thanks to automated control and preventive replacement of all essential components. This means that the continuity of your process is not jeopardized by unnecessary downtime.



ELEKTRONIKON CONTROLLER

The Elektronikon® controller is at the height of technology in sophisticated compressor control software. An upgrade will improve the overall reliability and uptime of your equipment, and extend connectivity to modern plant control systems.

Xchange programs

Replace major components with new more efficient components

The Xchange Program offers you the possibility to replace major components of your compressor with new more efficient components.

MOTOR XCHANGE PROGRAM

Energy consumption is the major cost in the total life cycle cost of any compressor. Under the Xchange Motor Program, the latest high efficiency motors are used to replace old less efficient motors or failed motors that require rewinding.

These new motors come complete with adaptation components making the exchange a quick exercise. The energy savings with the new motors are guaranteed.



ELEMENT XCHANGE PROGRAM

The overhaul is arranged in advance based on the expected life of the compressor element and condition monitoring. This proactive planning ensures that there is a reduced risk of failure and prevents production loss. The combination of Atlas Copco genuine parts and skilled expertise by Atlas Copco engineers ensures that overhauled elements are restored to their original highly performance levels, increasing your profitability.



CONVERTER XCHANGE PROGRAM

The Xchange Converter program is a one step replacement solution to upgrade Atlas Copco VSD compressors with new variable speed drives. The lifecycle of a variable speed drive progresses from active phase to the obsolete phase in just a few years. Towards the obsolete phase the converters become difficult and expensive to repair.

The Converter Xchange program easily overcomes this difficulty and ensures that the customer's equipment is back in operation after a minimal intervention period.



Genuine parts

Because Atlas Copco genuine parts are built according to the same quality standards as your compressor, you are guaranteed that your production, even after servicing your compressor, will remain at the same high level.

THE ADVANTAGES OF USING ATLAS COPCO'S GENUINE PARTS:

- **Longer life expectancy**

Regularly servicing your equipment using genuine spare parts ensures that your installation **will last longer**. We guarantee that each new component performs equally well as the part it replaces.

- **Superior quality**

Our genuine parts are manufactured to the same exacting standards as your installed compressor. They have passed the same endurance tests and proven to be the best protection for your investment.

- **Reliability and productivity**

Using genuine parts substantially lowers the risk of a production breakdown, which would not only be very costly, but could also endanger your product quality, deadlines and profit margins. In short, genuine parts offer optimal performance of your compressed air installation.

- **Energy savings and cost effectiveness**

Regular replacement of parts combined with the use of genuine Atlas Copco parts make your compressed air installation last longer and cause a minimal average pressure drop, which leads to energy savings and cost effectiveness and maximum air delivery at the lowest cost of ownership.

- **World class logistics**

The continuity of your production process can only be guaranteed when the quality spare parts arrive at the right place and the right time. With our genuine parts distribution system, operating 24/7, you can rest assured your production continuity is in safe hands.



Lubricants



Greases



Maintenance kits



Filters



Line Filters

Lubricants

Engineered to protect

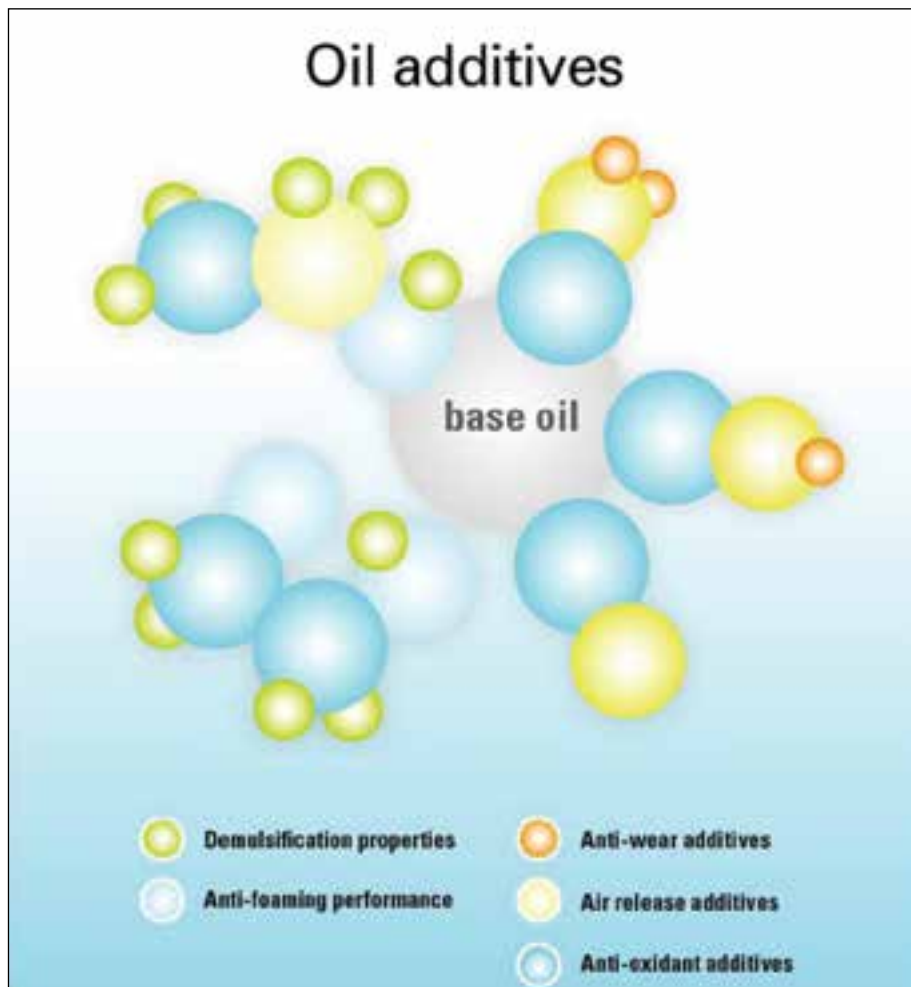

Atlas Copco lubricants are engineered with the exact right selection of additives that interact in just the right proportion to obtain optimal performance. The additives not only support the base lubrication requirements, they also interact in multi processes in the compressor.

THE PROPERTIES OF QUALITY

All our efforts are aimed at optimizing the performance of your Atlas Copco compressor for the longest lifetime at the **lowest operating cost**.

The experts in our laboratories are uniquely skilled in specifying lubricant properties for Atlas Copco compressors to operate optimally in a wide range of settings and conditions, during several thousands of hours.

Atlas Copco lubricants are a unique blend of chemical properties, engineered for **optimal performance** in their dedicated functions.

Atlas Copco Fluids for screw compressors

ROTO-INJECT FLUID

Atlas Copco Roto-Inject Fluid is specially formulated to protect your GA-GX rotary screw compressors and neutralize pollution. It guarantees the longest lifetime, trouble free, with constant performance, at the best operating cost.

Years of experience on thousands of types of Atlas Copco equipment have proven Roto-Inject Fluid to match all lubrication demands in varied conditions. It boasts an extended service interval of up to 4 000 hours for operation in a mild environment. This is critical to achieve the best reliability and reduce the service lifetime cost.



ROTO-XTEND DUTY FLUID

When your air compressors need to perform at top capacity, only the Atlas Copco lubricant is good enough. That's why it pays to use Roto-Xtend Duty Fluid. Atlas Copco superior performance long life PAO oil, specifically developed for use in Atlas Copco oil injected screw compressors.

Based on synthetic hydrocarbons and special additives, our engineered 8 000 h lubricant has proven its ability to meet all lubrication demands under widely varying conditions. Roto-Xtend Duty Fluid increases compressor reliability, reduces lifetime operating costs and makes your equipment last longer.



ROTO-FOOD GRADE FLUID

Roto-Foodgrade Fluid is a high performance fluid specifically designed for use in oil injected screw compressors operating in the food and beverage and packing industry. National and international regulations specify strict manufacturing standards regarding contamination risk management in this industry.

Our Roto foodgrade is based on a careful blend of synthetic fluids and additives that meet these stringent requirements, allowing for active Critical Control Points management (in an HACCP system) and providing increased customer confidence in the food products' safety.



Atlas Copco Fluids for piston compressors

PISTON FLUID

Piston compressors pose extreme demands to lubricants: the high compression temperature - possibly exceeding 150°C (300°F) - pressures up to 20 bar, condensation - typically during low cycle load - and dust contamination in installations that are not optimally maintained.

Traditional lubricants cannot cope with these extreme conditions, resulting in fast oil degradation, overheating and potentially irreversible damage and high repair costs. Therefore, high performing lubricants increase the equipment lifetime. The Atlas Copco Piston Fluid has been developed as a high resistance lubricant, withstanding severe conditions, with a long service interval and superior performance.

Considering the low oil content in piston compressors, often less than 2 liters, the economy of lesser quality oils simply is not worth the risk.



HiPER FLUID

HiPER Fluid is a premium quality reciprocating compressor lubricant, which has been developed for and tested in Atlas Copco's high pressure reciprocating compressors (product lines Intermech and GreenField)

Applications:

- Compressed Natural Gas Compressors
- Industrial Gas Compressors

HiPER Fluid meets the most stringent qualification in order to increase the performance and life time of your investment. The oil is specifically blended to handle local variations in gas composition.



AUTOMAN FLUID

Automan piston compressors pose extreme demands to lubricants: the high compression temperature, possibly exceeding 150°C (300°F), pressures up to 20 bar, condensation - typically during low cycle load - and dust contamination in installations that are not optimally maintained.

Traditional lubricants cannot cope with these extreme conditions, resulting in fast oil degradation, overheating and potentially irreversible damage and high repair costs. Therefore, high performing lubricants increase the equipment lifetime. The Atlas Copco Automan Fluid has been developed as a high resistance lubricant, withstanding severe conditions, with a long service interval and superior performance.

Considering the low oil content in piston compressors, often less than 2 liters, the economy of lesser quality oils is simply not worth the risk.



Atlas Copco Lubricants

ROTO-Z

Roto-Z is a high quality lubricant, uniquely tailored to the specific requirements of the Atlas Copco Z-compressors. Its special formulation yields top performance and maximum lifetime of all moving parts. Reliability is safeguarded and equipment availability is maximal.

Roto-Z is cost-effective too: drain intervals are doubled in comparison to conventional lubricants. Roto-Z incorporates the functional benefits of a preservative mineral oil, which allows for an extended on-site storage of several months.



ROTO-H PLUS

Roto-H Plus is a unique lubricant, especially created for Atlas Copco oil-free centrifugal ZH compressors. The heavy-duty blend provides optimum lubrication of the compressor sleeve bearings. In addition, Roto-H Plus guarantees top performance and maximum durability of all other moving parts. This improved reliability translates into maximum equipment uptime.

It is a highly cost-effective lubricant: drain intervals can extend up to 24 000 hours* with only a 6-monthly oil analysis in between.



* Subject to normal operating conditions.

ROTO-M

Roto-M is your best safeguard for good hypoid gear lubrication. It is a heavy-duty, high-viscosity blend, formulated specifically for the gear boxes on Atlas Copco MD absorption air dryers.

Roto-M provides the high film strength required in hypoid gear applications. It minimizes wear and tear and guarantees optimum lubrication of the MD worm gear drive, under all operating conditions. Its superior reliability translates into maximum equipment uptime.



RECIP OIL

Recip Oil is a unique lubricant, especially created for Atlas Copco oil-free reciprocating compressors and boosters. The special blend provides optimum lubrication for high pressure applications and guarantees top performance and maximum durability of all moving parts. This improved reliability translates into maximum equipment uptime.



Greases

Engineered to protect

To help your compressor perform to its optimal design standards, you need a grease that stays in place and provides effective protection and lubrication under challenging conditions. The longer the grease lasts, the longer the motor lasts, and the less lubrication maintenance for your compressor. With a full product range of Roto-Glide greases, you can select the grease to meet your specific requirements.

ROTO-GLIDE

Roto-Glide sets a new, high standard in motor bearing lubrication. Its special heavy-duty formulation provides improved bearing protection at higher operating temperatures. Because of its greater stability, Roto-Glide permits extended motor greasing intervals of up to 4 000 hours depending on the type and use of the motor.

Roto-Glide guarantees optimum lubrication of the electric motors used in Atlas Copco Z- and G-series air compressors. Improved reliability translated into maximum equipment uptime.



Maintenance kits

The parts you need, when you need them

SAVE TIME GETTING THE RIGHT PARTS

The Service kits supplied by Atlas Copco contain every item down to the last gasket. Just think of the time saved; time that without a service kit would be wasted checking different sources to get a complete set of the parts you need.

COVERS YOUR COMPLETE MAINTENANCE NEEDS

Service kits contain all the parts needed as part of a scheduled maintenance program. So from now on you can rely on one single source for all your spare parts. When installed by an Atlas Copco technician, his experience and training will keep downtime to the minimum and ensures your equipment will be kept in top condition throughout its operating life.

ADVANCED TECHNOLOGY FOR CLEAN CONDENSATE

For assured performance and maximum maintenance intervals, the specially designed OSC service kits are highly recommended. Each kit is designed to make life as easy and simple as possible, providing all the equipment needed for a fast, clean and trouble free element changeover.



Line Filters

Compressed Air Filters

PRODUCT DESCRIPTION

Building on many years of experience in compressed air solutions and through continuous in-depth research and testing, Atlas Copco has developed a complete range of top-of-the-bill DD, DDp, PD, PDp and QD filters according to the latest international standards which efficiently reduce all types of contamination with minimal pressure drop.



Filters

Protect your investment

COMPRESSOR OIL FILTRATION

Dust and dirt contaminating the compressor oil can lead to damage to or performance losses for rotors and their housings. Since the same oil lubricates the compressor element bearings, damage to these vital components could potentially lead to rotor contact and service failure.

Genuine Atlas Copco compressor oil filters have high performance and are composed of specific filter elements. Features include high-grade filtration efficiency, temperature resistance, and resistance to synthetic oils. Built to withstand high operating pressures, Atlas Copco filters have superior service life, thanks to their high dirt holding capacity.



COMPRESSOR AIR FILTRATION

Compressor rotors operate with minimal clearances, guaranteeing high performance. However, dirt particles can cause damage, reducing performance and potentially increasing operating costs. To safeguard the high-tech screw element at the heart of your investment, Atlas Copco focused on the intake air filtration system.

Atlas Copco uses special filtration elements to prevent contaminants from passing into the compressor. Yet, we designed them to allow the volume of air to freely Capacity FAD into the machine. Parts from other manufacturers can never match the performance of these genuine Atlas Copco parts.



COMPRESSOR OIL SEPARATION

Only genuine Atlas Copco replacement oil separator elements can offer extremely low oil carryover combined with low pressure differentials. This means better quality air and minimal operating costs through lower oil consumption and longer service life of fine filters installed downstream.



AIRnet

Compressed air piping system

AIRnet is a compressed air piping system that delivers quality air exactly where you need it, from compressor to the point of use. The unique benefits of AIRnet effectively reduce the cost of ownership of your piping system. Discover AIRnet at www.airnet-system.com

CUSTOMER BENEFITS

- **Fast** - Thanks to a smart design and low weight materials, AIRnet can be installed 70% faster than conventional systems.
- **Easy** - AIRnet pipes and fittings are assembled in just a few steps by a single installer, without the need for heavy machinery.
- **Reliable** - The durable, corrosion-free AIRnet pipes and fittings come with a 10-year warranty. Low friction and seamless connections minimize pressure drop.

www.airnet-system.com



Serving the oil and gas industry with energy efficient solutions



www.atlascopco.com/oilandgas